

Imperial College  
London



THE ROYAL BRITISH LEGION

**CENTRE FOR BLAST INJURY STUDIES**

AT IMPERIAL COLLEGE LONDON



2019

# CBIS Annual Report



The Royal British Legion

Centre for Blast Injury Studies

at Imperial College London

June 2020



# Centre for Blast Injury Studies Annual Report

---

**The Royal British Legion Centre for Blast Injury Studies  
at Imperial College London**

**[www.imperial.ac.uk/blast-injury](http://www.imperial.ac.uk/blast-injury)**

**London, June 2020**



# Contents

Introduction from Centre Director .....	1
The Centre for Blast Injury Studies and the Military .....	3
Impact.....	5
Links to civilian blast injury.....	8
Events .....	10
Media Activity.....	12
Outreach and Engagement.....	14
Governance and Staffing .....	15
Exemplar Research Findings.....	24
Appendix.....	45



## Invited Foreword

As I write, the world is experiencing a global health pandemic, the like of which has not been seen in living memory. Around the world, we are all experiencing the impact of this disease whether first hand through personal restrictions, sickness or bereavement or the secondary effects on society, finances or unrelated health issues.

The National Health Service are on the front-line but of course, in times of national and international crisis, the military are always on hand to support. Over the course of this pandemic, we have seen the Armed Forces take on huge logistical responsibility to enhance the National Health Service capability and provide much needed emergency medical cover across the United Kingdom. Veterans have also risen to the call. Team Rubicon, an international disaster relief organisation resourced primarily by veterans, has recruited thousands of volunteers. These 'Greyshirts' give up their time and energy and break cover from the relative safety of isolation to continue their service and support the national response to COVID-19.

As the focus of the world's attention lies with combatting this pandemic, it is also important that we do not forget the key lessons of the past or previous priorities. As the world endeavours to fight for our safety against this foe in the present, The Centre for Blast Injury Studies will continue to serve those who have experienced terrible wounds as a result of blast and those who will be damaged in the future.

The work being undertaken at the Centre for Blast Injury Studies will aid the recovery and rehabilitation of those who have and will suffer wounds and will contribute to reducing the risk and mitigating the impact for those living and working in the vicinity of explosive devices. However, it cannot undertake this mission alone and the Centre for Blast Injury Studies recognises and welcomes the need for collaboration with institutions and projects around the world. I have personally seen this in action through their contributions to The Centre for Conflict Wound Research, their partnership with the ADVANCE Study and their hosting of the 2019 Blast Injury Conference. This conference drew from key global knowledge and expertise in the areas of musculoskeletal injury and protection, head and brain injuries, civilian and non-combatant blast injury and paediatric blast injury.

The Centre aims for both academic and societal impact. In the past year the Centre has helped to write and distribute the Paediatric Blast Injury Field Manual, a publication that is having and will continue to have a practical and immediate impact on those living in countries where landmines, IEDs and unexploded ordnance create unimaginable suffering for children and their families.

I have served in the British Army in both Iraq and Afghanistan. Returning wounded from conflict I have dedicated my professional and personal life to supporting the Armed Forces Community and have fulfilled this role at The Royal Foundation, through the Invictus Games, at Team Rubicon UK and as the co-founder of the CASEVAC Club. As such, I am taking a long term view regarding the impacts of conflict on this community, of whom I am so proud, and the Centre for Blast Injury Studies shares this approach. Through their world-leading research and outputs, and with a collaborative approach alongside organisations such as the Royal Centre for Defence Medicine and the Queen Elizabeth Hospital in Birmingham, the Centre for Blast Injury Studies is helping to bring to light complex issues resulting from blast, and solutions regarding musculoskeletal, cardiovascular and mental health.

At present, the world is quite rightly focused on tackling the corona-virus but the issues resulting from blast injury will not go away, and neither should the nation's commitment - through public, private and academic institutions - to provide the best medical care for those who have served and who continue to serve. I therefore urge you to maintain your support for the Centre for Blast Injury Studies and those across the world who are working to mitigate the risk and the impact of blast injuries.

**David Wiseman**

**Co-Founder, The CASEVAC Club**

**Head of Programmes: Supporting Those Who Serve, The Royal Foundation**





## Introduction from Centre Director

The Centre for Blast Injury Studies (CBIS) has had another very busy year during 2019. Our Centre members continue to produce excellent research across the interdisciplinary spectrum of blast injury, and this year has seen an excellent set of peer-reviewed publications. We are making strides to improve knowledge in the field of blast injuries. Two main events come to mind when thinking back to our achievements in 2019. The first of these was the two-day international Blast Injury Conference which we hosted here at Imperial College in July. This was attended by over 200 people from around the world, and it emphasised the incredible work that is taking place in the UK and internationally in the field. It was a chance for students and researchers of all levels to network and discuss their work. A second highlight was the launch of the Paediatric Blast Injury Field Manual in May. Many CBIS members were involved at different stages of the work that led to the creation of this manual, and the success of the manual to date has been hugely inspiring. There is more on the horizon for this, and we see 2020 as another important year in this area.

Towards the end of 2019, we started to put together our case study for the national 2021 research assessment (REF) exercise. This gave us the opportunity to reflect on the impact that the Centre's research has had. It focused on impact from 2013 to 2020 and we have found it highly rewarding to bring together the examples of where our work has impacted people and decisions. We have included a section within this annual report which details some of this impact and we hope that you enjoy reading more about the impact that research can have on the end-user – be that a patient, an organisation or a judicial decision-making body.

As well as looking back on a very successful 2019, we also look forward to what 2020 has to offer. Many Centre members will be moving to the brand-new Sir Michael Uren Hub on Imperial's White City Campus during 2020 and 2021. This will be an important move for many of us as it will bring even more collaborations between research groups in different fields. We'll provide more details about this in future annual reports.

We hope you enjoy reading about the work that has been undertaken in 2019.

**Professor Anthony M J Bull FEng**

**Director, The Royal British Legion Centre for Blast Injury Studies at Imperial College London**

---

# A YEAR IN NUMBERS

---

---

23

PEER-REVIEWED  
PUBLICATIONS

---

26

CONFERENCES ATTENDED  
AROUND THE WORLD

---

34

INVITED TALKS

---

220

DELEGATES AT THE BLAST  
INJURY CONFERENCE 2019

---

2,800

PAEDIATRIC BLAST INJURY  
FIELD MANUALS PRODUCED

19,000

DOWNLOADS OF 'BLAST  
INJURY SCIENCE AND  
ENGINEERING' IN 4 YEARS

---

>£4.5m

OF RELATED PROJECT FUNDING RECEIVED

---

Figure 1: 2019 – A Year in Numbers

This infographic provides an overview of some of the Centre's achievements across the year.

---

# The Centre for Blast Injury Studies and the Military

The Centre has been privileged to work in full cooperation with the UK military since the establishment of Imperial Blast in 2008, and then onwards into CBIS from 2011. Over the course of Imperial Blast and CBIS, twelve military personnel have been directly embedded in the Centre to undertake short projects, Masters degrees or PhDs. In addition, many have also had direct roles in the supervision of researchers and the strategic direction of the Centre. The support provided by the military has been incredibly valuable, and highlights the importance, and direct impact, of the work that is undertaken. There is a two-way flow of information, with the research being directly informed by real-world data from injuries and the research then translating into improvements for military personnel (for example through personal protective equipment or treatments).

Below are some key people and organisations who have supported the Centre:

## Professor Jon Clasper – Centre Clinical Lead

Professor Jon Clasper was one of the founding members of Imperial Blast and CBIS, working as the Military Clinical Lead. He was the Defence Professor in Trauma and Orthopaedics from 2009-2014 and has provided important first-hand knowledge of the clinical needs of the military, having been deployed in conflict zones on multiple occasions. Jon left the military in November 2019 but remains on the CBIS Management Group as the Clinical Lead, continuing to provide vital insight into both military and civilian blast injuries.

## Defence Medical Services

The Centre has been fortunate to have had very strong links with Defence Medical Services (DMS) throughout the duration of our funding. DMS is made up of the Army Medical Service, Navy Medical Service, the Royal Air Force Medical Service and the Joint Medical Group. Its support, through the Surgeon General and Medical Director positions, ensure the continued placement of excellent military personnel within the Centre to undertake research degrees and provides vital access to military data and direct translation of our learning to clinical practice. Data provides information about injuries from past conflicts (including scans and post-mortem data), how the injured were treated, and equipment that is used or being developed.

We have worked closely with Surgeon Vice Admiral Phillip Raffaelli, Air Marshal Paul Evans, Surgeon Vice Admiral Alasdair Walker, Lieutenant General Martin Bricknell and Air Vice-Marshal Alastair Reid in their positions as Surgeon General, and Surgeon Vice Admiral Alasdair Walker, Brigadier Timothy Hodgetts and Air Commodore Rich Withnall in their capacities as Medical Director and in additional roles. All have provided enduring knowledge and support. We are also fortunate that Lieutenant General Louis Lillywhite, former Surgeon General (2006-2009), has been a member of the Centre's Advisory Board for a number of years.

We also benefit from links with the Royal Centre for Defence Medicine at the Queen Elizabeth Hospital Birmingham. Here many military medical personnel are trained, and this is the main hospital that military personnel go to after sustaining injuries in conflict.

Due to the nature of the Centre's research, we have had strong interactions with the Defence Professors; Professor Jon Clasper and Surgeon Captain Sarah Stapley (Trauma and Orthopaedics); Surgeon Captain Mark Midwinter and Surgeon Captain Rory Rickard (Surgery); Professor Peter Mahoney (Anaesthesia and Critical Care); and Group Captain Alex Bennett (Rheumatology and Rehabilitation). The post-holders change every few years, but we ensure our ongoing collaborations with each through projects at the Centre and additional ones funded through other sources (such as the ADVANCE Study). We also collaborate closely with Colonel Iain Gibb, Defence Consultant Advisor in Radiology.

## **Military Research Students**

Twelve serving military officers have conducted research for higher degrees at the Centre over the last decade and we are incredibly grateful for their input into the research area. The military officers have come from different disciplines within the medical field, covering orthopaedic surgery, general surgery, and physiotherapy. This breadth of background brings different skills to the studies and the research groups that the students are embedded within.

## **Defence Science and Technology Laboratory (Dstl)**

Some members of the Centre work closely with Dstl, a UK government agency for applying science and technology to the defence and security of the UK. Projects have focussed on developing experimental and computational models of blast injury, and evaluating protective equipment for mitigation of injuries to military personnel.

## **ADVANCE Study**

The ArmeD SerVices TrAuma Rehabilitation OutCome (ADVANCE) study is a longitudinal study which is investigating the outcomes of battlefield casualties from the UK Armed Forces who were deployed to Afghanistan between 2002 and 2014. It looks at physical and psycho-social outcomes. The study is a collaboration between Imperial College London, King's College London and the Defence Medical Rehabilitation Centre (DMRC). Professor Anthony Bull is a member of the study's Project Board which ensures strong links between the Centre and the study. Members of CBIS and the CBIS Advisory Board are also members of the ADVANCE Charity Board of Trustees.

Further information about the study and the analysis of data that CBIS members are working on will be included in the 2020 CBIS Annual Report.

## **United States Military**

In 2017-2018 Lieutenant Colonel Dan Stinner from the US Army was based at the Centre as a Visiting Researcher. Lt Col Stinner is an orthopaedic surgeon (now working at Vanderbilt University Medical Centre) who worked on a variety of research projects whilst at the Centre, including the effect of blast waves on cellular response and the efficacy of foot and ankle orthoses on functional outcomes. Whilst here, he helped to arrange the annual Networking Event, which that year (2017) focused on UK-US collaborations. The important connections that the Centre has made through Lt Col Stinner and other colleagues continue to develop, and we look forward to many further interactions.

# Impact

The Centre's unique collaboration between engineers, scientists and clinicians, all with a focus on blast injuries, has produced important outputs over the last decade. This section briefly discusses some of the impact that the Centre has had in the field of blast injury.

## Mitigation

Centre research<sup>1</sup> has directly contributed to a project on Army gloves run by the Ministry of Defence. The research underpinning this knowledge focussed on understanding injuries to specific joints within the hand which are particularly disabling. With this knowledge, protective solutions such as gloves can be specifically designed. You can read more about this research on page 27.

Dr Spyros Masouros has been a member of the NATO Human Factors and Medicine task groups 198 and 271 who consider injury assessment methods for vehicle occupants in blast-related events and provide recommendations to NATO's standardisation committee (STANAG). Research on the pathophysiology and epidemiology of blast injury, especially to the lower extremity, conducted in the Centre<sup>2,3,4,5,6</sup> has contributed directly to the workings of these NATO groups.

Centre work on the probability of injury from energised blast fragments is being used in injury-predicting algorithms used to predict the probability of injury from a blast event and therefore help in deciding on coverage areas for armour.

## Treatment

As discussed in previous annual reports, a key achievement of the Centre has been the recommendation of changes to the application of pelvic binders following blast injury. This followed work which showed that the accurate positioning of the pelvic binder at a particular level is important and reduces blood loss<sup>7</sup>. The recommendation for accurate positioning has become standard method for Battlefield Advanced Trauma Life Support (BATLS) courses since the work was published. The placement has also been adopted by the United States Military which will have an even larger impact on saving lives.

The production and distribution of the Paediatric Blast Injury Field Manual<sup>8</sup> to conflict zones around

---

<sup>1</sup> Carpanen D, Kedgley AE, Shah DS, Edwards DS, Plant DJ, Masouros SD (2019). Injury risk of interphalangeal and metacarpophalangeal joints under impact loading. *Journal of the mechanical behaviour of biomedical materials*, 97: 306-311. (<https://doi.org/10.1016/j.jmbbm.2019.05.037>).

<sup>2</sup> Grigoriadis G, Carpanen D, Webster CE, Ramasamy A, Newell N, Masouros SD (2018). Lower limb posture affects the mechanism of injury in under-body blast. *Annals of Biomedical Engineering*. 47(1): 306-16. (<https://doi.org/10.1007/s10439-018-02138-4>).

<sup>3</sup> Ramasamy A, Hill AM, Masouros SD, Gibb I, Phillip R, Bull AMJ, Clasper JC (2013). Outcomes of IED foot and ankle blast injuries. *The Journal of Bone and Joint Surgery – American volume*, 95(5): e25. (<https://pubmed.ncbi.nlm.nih.gov/23467873/>).

<sup>4</sup> Masouros SD, Newell N, Bonner TJ, Ramasamy A, West ATH, Hill AM, Clasper JC, Bull AMJ (2013). Design of a traumatic injury simulator for assessing lower limb response to high loading rates. *Annals of Biomedical Engineering*, 41: 1957-1967. (<https://doi.org/10.1007/s10439-013-0814-6>).

<sup>5</sup> Newell N, Neal W, Pandelani T, Reinecke D, Proud WG, Masouros SD (2016). The dynamic behaviour of a vehicle floor in under-body blast. *Journal of Materials Science Research*, 5(2): 65-73. (<http://www.ccsenet.org/journal/index.php/jmsr/article/view/55879>).

<sup>6</sup> Mildon PJ, White D, Sedman AJ, Dorn M, Masouros SD (2018). Injury risk of the human leg under high rate axial loading. *Human Factors and Mechanical Engineering for Defense and Safety*, 2(1): 5. (<https://doi.org/10.1007/s41314-018-0009-x>).

<sup>7</sup> Bonner TJ, Eardley WG, Newell N, Masouros S, Matthews JJ, Gibb I, Clasper JC (2011). Accurate placement of a pelvic binder improves reduction of unstable fractures of the pelvic ring. *Journal of Bone and Joint Surgery*, 93(11): 1524-1528. (<https://doi.org/10.1302/0301-620X.93B11.27023>).

<sup>8</sup> Paediatric Blast Injury Partnership and Field Manual: <https://www.imperial.ac.uk/blast-injury/research/networks/paediatric-blast-injury-field-manual/>

the world has the potential to save thousands of lives. First responders and medics from humanitarian organisations are being trained using the manual, and translation of the manual into further languages (already available in English, Arabic, Dari and Pashtu) will ensure that it is more widely used, and therefore that the impact on the children involved in blast incidents is more widely understood.

## Rehabilitation

The work that Centre researchers have done on foot and ankle injuries (discussed in detail in the 2018 Annual Report) has helped to inform the Armed Forces Compensation Scheme and influence changes to pension benefits for those who have suffered particular injuries. The research<sup>9</sup> showed the severity of calcaneal injuries. Whilst only a small number of military personnel have been affected by this injury, the change to the pension benefits has the potential to have a long-term impact on any personnel who are injured in the future.

Imperial has also agreed to partner with the new National Rehabilitation Centre at Stanford Hall as a collaborator in leading the national civilian rehabilitation research that leverages the military experience.

## Repository of information

The Centre curated the Blast Injury Science and Engineering book in 2016 and this is a key source of material for many in the field. To date, there have been over 19,000 downloads of the book showing its relevance within the field. A second edition of the book is currently in preparation for publication later in 2020.

The Centre also acts as a repository of information through its network of experts across multidisciplinary fields. The Centre members are therefore approached as a source of advice or expert comments (see below).

## Influencing policy and practice

Centre members are experts in analysing mechanisms of injury after blast events. As such, individuals have been asked to be involved in the inquest into the 1974 Birmingham Pub Bombings (see Media section) and the All-Party Parliamentary Group on Explosive Threats report<sup>10</sup>. Through these channels, the Centre can make recommendations to policy makers and politicians, and advocate for change.

Further to the work on the 1974 Birmingham Pub Bombings, Professor Anthony Bull is currently leading a panel of experts that have put together an overview report for the Manchester Arena Inquiry.

## Spin-out company

Work part-funded by the Centre has resulted in a spin-out company being formed called SERG Technologies. This came about from research undertaken by Dr Ravi Vaidyanathan and Dr Samuel Wilson. The company has created a platform for gathering biometric data from wearables which will allow the user to gather information about themselves. This has potential applications in prosthetic control, gesture recognition and symptom monitoring.

## People

As research leaders, we are in a position to support and engage others in research, and help them progress in their careers. Previous Centre members have gone onto many different jobs after finishing at

---

<sup>9</sup> Ramasamy A, Hill AM, Phillip R, Gibb I, Bull AMJ, Clasper JC (2011). The modern “deck-slap” injury - calcaneal blast fractures from vehicle explosions. *The Journal of Trauma: Injury, Infection & Critical Care*, 71(6): 1694-1698.(DOI: [10.1097/TA.0b013e318227a999](https://doi.org/10.1097/TA.0b013e318227a999)).

<sup>10</sup> APPG Report on Explosive Threats: <https://revivecampaign.org/wp-content/uploads/2019/10/APPG-Report.pdf>

the Centre and we still have strong collaborations and links with many of them. Previous Centre members have moved to work on other grants, secured fellowships, started academic positions, returned to medical roles and taken up positions within industry. Through this variety of new roles, the Centre's network further expands.

## **New capabilities**

Within the Centre we have bespoke equipment that allows us to undertake unique experiments. An example of this is our bespoke shock tube which is used by many groups across the Centre. The shock tube is used for research into musculoskeletal injuries (e.g. fractures), heterotopic ossification, brain injury and hearing loss. Centre members have built this shock tube to be adaptable to the users' needs and research field. The anti-vehicle underbody blast injury simulator (AnUBIS) is another bespoke piece of equipment. This allows the simulation of a blast event under a vehicle so that we can better understand the injuries caused, and how to protect against them. More information about some of the experimental capabilities within the Centre can be found on pages 35 and 36.

The Centre also employs computational capabilities that allow modelling of different types of injuries and assess the efficacy of current and novel designs or protection. Examples of these include modelling foot and ankle injuries after under-vehicle blast, predicting the formation of ectopic bone in the residual limb of an amputee, and investigating the forces encountered at the hip joint of amputees. These unique capabilities are being used to develop new rehabilitation techniques, design better prostheses and orthoses, recommend new treatments and surgical interventions, and design blast mitigating footwear, helmets and other personal protective clothing.

## Links to civilian blast injury

Whilst the Centre is funded to focus on injuries to military personnel, the work is also highly relevant and translatable to civilians who have suffered, and will suffer, from blast injuries. Worldwide, explosive devices are used in warfare and in terrorist attacks and as such, blast injuries are experienced in great numbers. There are particularly high rates of blast injuries in low- and middle-income countries in conflict zones where landmines are used in large numbers and their legacy will persist for decades. Below we discuss some of the grants and initiatives that Centre members also work on which help to understand blast injuries outside of the military context. Much of the research described below fits within treatment and rehabilitation; two of the three core areas that CBIS focuses on. A common theme amongst many of the below grants is the topic of prosthetics and orthotics (P&O), which is an important aspect of the ongoing care that amputees require after an injury. Whilst the research does not look at mitigation (the third of the focus areas for CBIS), there is always potential to do so in the future.

### Trauma Bioengineering Network

The Trauma Bioengineering Network (TBN) was set up in 2015 as a parallel initiative to CBIS which focused on civilian injuries instead of military. The network initially brought together experts from Imperial College London and the Major Trauma Centre at St Mary's Hospital to translate lessons learned from CBIS research into the civilian domain. The membership has since been expanded to include members of some of the grants mentioned below, and includes scientists, engineers and clinicians.

### Paediatric Blast Injury Partnership

The Paediatric Blast Injury Partnership was established in January 2018, between Imperial College London and Save the Children UK. This was formed to focus on the global emergency of paediatric injury. In May 2019, the partnership published a Field Manual which provides guidance on each stage of the care pathway for children who have suffered a blast injury. The response to the manual has been overwhelmingly positive and it has now been produced in English, Arabic, Dari and Pashtu. Copies of the manual have been shipped around the world to areas where it is most needed. More information about the Partnership can be found in the 2018 annual report and on the CBIS website.

### NIHR Global Health Research Group on POsT Conflict Trauma; PrOTeCT

This grant is a collaboration between researchers at Imperial College London (from the Departments of Bioengineering, Materials, Mechanical Engineering, and Surgery & Cancer), the American University of Beirut Medical Centre and the University of Moratuwa (from the Departments of Mechanical Engineering and Electronic Engineering). Landmine explosions have been one of the leading causes of traumatic amputation in Sri Lanka, and it is estimated that 90% of the 160,000 amputees lack proper prosthetic limbs. The aim of the grant is to develop and clinically deploy appropriate technology for limb salvage which will help to reduce amputations.

The grant focuses on 1) Data collection, capacity building, sustainability and policy making; 2) Surgical education and training; 3) Surgical planning and bespoke reconstruction technology; and 4) Biodegradable structural biomaterials. Combining the work in each of the four work packages will help those who may suffer from a blast injury in the future. The focus when creating new technology and materials is to ensure that the equipment and techniques can be manufactured and used within the country, rather than having to rely on expensive parts from overseas.

Ultimately, the Group will be able to access rare data and experiences to allow an improved understanding of civilian blast injury where global terror remains a threat to civilian populations and this will help us better understand the healthcare burden post conflict to influence and enable overseas intervention.



## **EPSRC Low Cost Through Knee Prostheses; TaKeuP grant**

The overall aim of this proposal is to address the societal needs of the large number of through-knee amputees in low- and middle-income countries (LMICs) through the design, development and translation of novel frugal technologies. The project directly targets end users (prosthetists and amputees) in Cambodia with a view to future expansion into the Philippines, Myanmar, Indonesia and Sri Lanka. Cambodia is one of the world's most landmine affected countries with over 64,000 casualties recorded since 1979 and over 25,000 amputees. Currently there are around 10 million people in South East Asia, India and Sri Lanka who need, but do not have access to, prosthetic and orthotic (P&O) services and there is a deficit of about 40,000 professionals. The team at Imperial College have a key partnership with the prosthetics and orthotics NGO Exceed Worldwide and the Exceed Research Network who have critical links around the world.

The designs produced by the team have been presented to the International Committee of the Red Cross (ICRC) and there are ongoing discussions with other prosthetics manufacturers.

## **Research England Grand Challenges Research Fund internal grants**

There are also a number of smaller grants which provide initial funding, and which could lead to larger applications after information gathering. These look to explore the prosthetic and orthotic needs in Sub-Saharan Africa, investigate prosthetic and orthotic needs in Sri Lanka and to improve prosthetic and orthotic training and healthcare services in Rwanda.

## **EPSRC Centre for Doctoral Training in Prosthetics and Orthotics**

This Centre for Doctoral Training (CDT) is led by the University of Salford, but is in partnership with the University of Strathclyde, the University of Southampton and Imperial College London. The CDT aims to become a leader in research training and translating research into innovation in the P&O field. Many of the projects will be relevant to the global health agenda and could therefore link with the injuries that many civilians sustain as part of blast incidents.

The CBIS team is passionate about using the knowledge gained through the Centre's work on military blast injuries to improve the lives of civilians in conflict environments around the world. Impact and improvements made in one setting can significantly strengthen the other.

## Events

There have been a number of important events for the Centre throughout 2019. Some of these are discussed in more detail over the following pages.

### Blast Injury Conference 2019

The Blast Injury Conference 2019 followed on from the success of the 2018 conference. Whilst the 2018 meeting was predominantly a national meeting, the 2019 conference invited delegates from around the world. The two-day meeting was a great success with 220 delegates attending, and many presenting their work. With delegates from 10 different countries around the world, there was a great breadth to the research presented which included discussions of different clinical techniques and research models.

The conference was lucky to have 4 exceptional plenary speakers across the two days who presented on very different aspects of blast injury. On day one of the conference Professor Molly Stevens (Imperial College London) discussed exploiting cell-material interactions for musculoskeletal application and Professor David Brody (Uniformed Services University of the Health Sciences, USA) presented on blast-related traumatic brain injuries from the wars in Iraq and Afghanistan. On day two Dr Ghassan Abu-Sittah (American University of Beirut Medical Centre) presented a talk entitled 'Conflict Medicine and the "War to end all wars": Rising up to the challenges of protracted conflict' and Mr Alistair Spearing gave the final plenary talk entitled 'Why I don't need to change my socks anymore: life beyond the blast radius', giving a personal view of his journey after a blast injury.

The sessions at the conference covered a wide range of topics, including Musculoskeletal injury, Head and brain injury, Hearing loss, Biology/physiology of blast, Point of wounding & casualty evacuation, Rehabilitation, and the Psychological effects of blast injury.

As well as excellent presentations at the conference, we also welcomed His Royal Highness Prince Harry the Duke of Sussex on day one of the conference. The Duke was greeted by Professor Alice Gast (Imperial's President), Professor Ian Walmsley (Imperial's Provost), Professor Anthony Bull (CBIS Director) and Admiral of the Fleet the Lord Boyce (Chair of the CBIS Advisory Board). The Duke was introduced to the Centre's Management Group and some members of the Centre for brief discussions and then he stayed to listen to presentations given by Professor David Brody and David Henson.



Thanks go to all those who contributed to the conference, and particularly those involved in the organisation of the conference: Dr Spyros Masouros (Conference Chair), Dr Lucy Foss, Surg Lt Cdr Louise McMenemy and Lt Emily Ashworth.



## Visit from Rt. Hon. Tobias Ellwood MP

Tobias Ellwood MP visited the Centre in January 2019 to learn about the work undertaken here. He visited the Centre in his capacity as the Minister for Defence People and Veterans. Professor Anthony Bull gave the Minister an overview of CBIS' activities and facilities, which was then followed by a tour of the labs where two military PhD students presented their projects. The Centre's Management Group and members of the Centre's Advisory Board were also in attendance at the meeting.

## Combined Services Orthopaedic Society (CSOS)

This year, the Combined Services Orthopaedic Society meeting was hosted by CBIS and held at Imperial College London. One former and two current members of the Centre organised the meeting. This is another important link between the Centre and military activities in this area. A number of Centre members, both military and civilian, presented their research at CSOS. Louise McMenemy (Centre PhD student) was awarded the Best Clinical Paper prize for her presentation entitled 'Pattern of upper limb amputation associated with lower limb amputation: the UK experience from Iraq and Afghanistan'.

## Annual Away Day

The 2019 away day started with an update from Professor Anthony Bull about the year to date and plans for the future, including many Centre members moving to the new White City campus. The afternoon team-building event took the form of an escape room experience. The Centre's PhD students and postdoctoral researchers split into four different teams to compete to find all the clues and escape the rooms in the fastest time. It was a closely fought competition and everyone had a great afternoon!





# Media Activity

Below are some images representing examples of our media activity in 2019. To read a specific article, click on the relevant image. Other media mentions are listed on the following page.



## Birmingham pub bombings victims had 'unsurvivable' injuries

BBC News  
March 2019



## Declassified Podcast interviews with Dave Henson and Emily Mayhew

Declassified Podcast  
April and May 2019

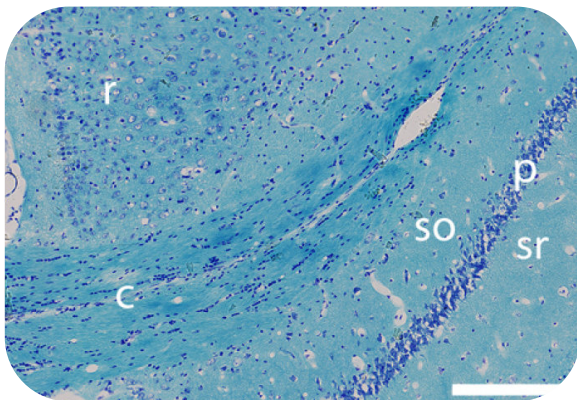

## Head injury effects halted by xenon gas, finds first ever lifelong study in mice

Imperial College article  
May 2019



## British doctors launch world's first handbook for child blast injuries

Save the Children  
May 2019



## Engineering, medicine, and science combine at the 2019 Blast Injury Conference

Imperial College article  
July 2019

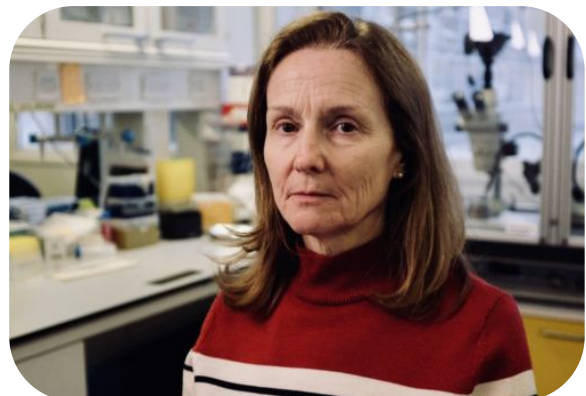

## Syrian conflict: Helping children through the horror of bomb blasts

BBC News  
July 2019

## Additional media mentions throughout 2019:

- *Birmingham pub bombings victims had 'unsurvivable' injuries* – BBC News, March 2019
- *Birmingham pub bombing victims sustained unsurvivable injuries, inquest told* – Belfast Telegraph, March 2019
- *Birmingham pub bombing: victims' relatives call for justice after inquest verdict* – The Guardian, March 2019
- *Declassified Podcase Episode 23* – Dave Henson, April 2019
- *Declassified Podcast Episode 25* – Emily Mayhew, May 2019
- *Head injury effects halted by xenon gas, finds first ever lifelong study in mice* – Imperial College London, May 2019
- *Xenon gas 'may prevent an early death and long-term cognitive impairment' in patients who suffer traumatic brain injuries* – Mail Online, May 2019
- *First manual on child blast injuries launched by Imperial and Save the Children* – Imperial College London, May 2019
- *British doctors launch world's first handbook for child blast injuries* – Save the Children, May 2019
- *'A war on children': Three in four child casualties caused by explosive weapons* – SBS News, May 2019
- BBC Radio 4's Today Programme, May 2019
- *Blast Injuries: The impact of explosive weapons on children in conflict* – Relief Web, May 2019
- *UK doctors launch guide for Syrian medics battling to save children's lives* – Reuters, May 2019
- *Child blast injuries: UK doctors launch first medical handbook in war zones* – Sky News, May 2019
- *Wars may end, but their toll on children doesn't* – The Sydney Morning Herald, May 2019
- *How to protect the children on the frontline* – Save the Children, July 2019
- *Speech: Kevin Watkins at the Blast Injury Conference* – Save the Children, July 2019
- *Engineering, medicine, and science combine at the 2019 Blast Injury Conference* – Imperial College London, July 2019
- BBC's Victoria Derbyshire Programme, July 2019
- *Syrian conflict: Helping children through the horror of bomb blasts* – BBC News, July 2019
- *Q&A: How skin cells from foot soles could help relieve amputees of stump injury* – Imperial College London, October 2019

## Outreach and Engagement

During 2019 we have again been involved in a range of outreach and engagement activities. Below we provide more information about some of these, and we would like to thank all those who have taken time to help.

### Great Exhibition Road Festival – June 2019

The CBIS team joined forces with colleagues working on a Global Challenges Research Fund grant (see page 9) to produce a stand about amputees in Cambodia and rehabilitation in general. The stand displayed a variety of prosthetics and orthotics from Cambodia to spark discussions about the similarities and differences between equipment used in Cambodia and the UK. Visitors to the stand were interested in the requirements for different materials and designs and the projects that Imperial researchers are working on. We also put the public through some rehabilitation-type exercises to highlight the strength that is required to help amputees walk with their prosthetics.

Thanks to all the researchers who were involved in the stand – particularly given that the Festival took place on one of the hottest weekends of the year and we were in a very warm marquee!

### ‘Fragments’ – a CBIS podcast series

Two new episodes of the ‘Fragments’ podcast were published in 2019, with a number of others having been recorded ready for release in 2020. Sarah Dixon Smith and Shruti Turner continue to do a great job in putting these together. Episode 6 welcomed Dr Emily Mayhew to discuss the work of the Paediatric Blast Injury Partnership and episode 7 was a discussion with Professor Anthony Bull, Centre Director and Head of the Department of Bioengineering, about the Centre’s research and how it is being used around the world. All the podcasts in the Fragments series can be accessed via this site: [https://soundcloud.com/fragments\\_podcast](https://soundcloud.com/fragments_podcast)

### Additional engagement events throughout the year

Shruti Turner won the “I’m an Engineer Get Me Out of Here” competition on Twitter in March 2019. This involved school children asking Shruti and the other competitors questions about themselves and their work, and each day someone got voted off. Shruti was the winner after all her fellow competitors were voted off. The prize was £500 to be spent on public engagement activities.

Emily Mayhew has spoken at a number of events throughout the year to highlight the work of the Centre and others in the field. Her talks have been at places such as the Royal Greenjackets Museum (Winchester), the Walthamstow Western Front Association, Save the Children Centenary Conference, the Spitfire Society Annual Event and the Chelsea History Festival.

### Recognition of achievements

The Centre nominated Sarah and Shruti for the President’s Student Award for Excellence in Societal Engagement at the start of 2019 and whilst they did not win the main prize, their notable contributions to societal engagement were highly commended by the panel. The Centre is very grateful to the two of them for all their hard work and commitment in this area.

# Governance and Staffing

## Governance

### The Royal British Legion

The Royal British Legion have been the core funders for the Centre and provide ongoing oversight of the Centre's work. Members of The Royal British Legion attend events run by the Centre and Professor Bull meets with the Legion's Director of Operations for discussions about the Centre and formal reporting.

### Imperial College London

Imperial recognises CBIS as one of twenty Centres of Excellence. The Centre therefore provides an annual formal report to the Vice Provost of Research and Enterprise and smaller updates about activities every two months. The formal reports are considered and scored on the risk to sustainability, the Centre's original objectives, its outputs, and the leadership and governance. The institution's continued support of the centre is contingent upon good scores in these categories and gives CBIS a high-profile institutional backing.

### Management Group

Professor David Sharp from the Department of Brain Sciences at Imperial joined the Management Group in 2019 as an Associate Director. He joins the Centre Director (Professor Anthony Bull), Clinical Lead (Professor Jon Clasper), two other Associate Directors (Professor Alison McGregor and Dr Spyros Masouros) and the Research Programmes Manager (Dr Lucy Foss) who meet monthly to discuss the Centre's strategic direction and operational workings. Professor Sharp has been part of the Centre for many years and has provided leadership in the area of head and brain injury.

### Advisory Board

The CBIS Advisory Board continues to meet twice a year and provides advice to the Centre's Management Group. In 2019 we welcomed Sir Bill Rollo onto the Advisory Board. Sir Rollo is a former senior British Army officer, having served from 1977-2013. His final role in the Army was as the Deputy Chief of Defence Staff (Personnel & Training) from 2010-2013. Since leaving the Army he has had a variety of charitable roles with organisations including the Commonwealth War Graves Commission, King Edward VII Hospital and the Scar Free Foundation.

Sadly, we also lost a member of the Board in 2019 with the sad passing of Ian Stopps in October. Our thoughts are with all his family.

Members of the Board have academic, clinical, defence and industry expertise and provide strong support and guidance in these areas, with significant additional input provided outside the regular meetings.

### Military Amputee Research Advisory Group

The Military Amputee Research Advisory Group met for the second time since its establishment in 2018. The Group is chaired by Professor Alison McGregor and the meetings have included very useful discussions about rehabilitation and prosthetics. The Advisory Group provide input into projects that work with military amputees, giving advice about protocols and delivery. The Group's membership includes military amputees, military clinicians and representatives from veterans' organisations.

## Staffing

Throughout 2019 the Centre was made up of just over 50 members from seven different departments within the College; Bioengineering, Brain Sciences, Civil & Environmental Engineering, Dyson School of Design Engineering, National Heart & Lung Institute, Physics, and Surgery & Cancer. Our researchers continue to work at the interface of several different disciplines.

In 2019 we welcomed three new postdoctoral researchers, one new Centre Administrator and five new PhD students (more information about these new members is on the following pages).

## Centre academics

We currently have 16 academics within the Centre who work across the different clinical priorities and who supervise PhD students and postdoctoral researchers.

Professor Anthony Bull (Bioengineering) – *Centre Director*  
Professor Jon Clasper (Bioengineering) – *Clinical Lead*  
Dr Spyros Masouros (Bioengineering) – *Associate Centre Director*  
Professor Alison McGregor (Surgery & Cancer) – *Associate Centre Director*  
Professor David Sharp (Brain Sciences) – *Associate Centre Director*  
Dr Robert Dickinson (Surgery & Cancer)  
Dr Mazdak Ghajari (Dyson School of Design Engineering)  
Dr Claire Higgins (Bioengineering)  
Dr Angela Kedgley (Bioengineering)  
Dr Andrei Kozlov (Bioengineering)  
Dr Andrew Phillips (Civil and Environmental Engineering)  
Dr Bill Proud (Physics)  
Professor Sara Rankin (National Heart & Lung Institute)  
Dr Tobias Reichenbach (Bioengineering)  
Professor Andrew Rice (Surgery & Cancer)  
Professor Mark Wilson (Surgery & Cancer)

## Achievements

Each year we like to celebrate the achievements of Centre members. These can range from awards for research to appointments on committees/councils. Well done to all those listed below for their achievements in 2019.

- Dr Mazdak Ghajari was appointed to the Scientific Review Committee of the International Research Council of Biomechanics of Injury (IRCOBI).
- Dr Mazdak Ghajari was appointed to the Home Office Science Advisor Committee.
- Mr David Henson was appointed as a Trustee of the ADVANCE Study Charity.
- Dr Andrew Phillips was appointed as a Committee Member of the British Orthopaedic Research Society.
- Dr Andrew Phillips was a Guest Editor for a Special Issue of Applied Sciences in Skeletal Biomechanics.
- Dr Tobias Reichenbach was appointed as Reviewing Editor for eLife, a leading open-access life science journal.
- Shruti Turner and Sarah Dixon Smith were Highly Commended for their contributions to Societal Engagement as part of the Imperial College London President's Awards 2019.
- Mr Xiancheng Yu was awarded an IRCOBI travel award.



## New Postdoctoral Researchers



**Oluwalogbon (Lobby) Akinnola** completed his PhD within the Department of Bioengineering at Imperial College London. His thesis focused on developing a musculoskeletal model of the wrist. At the end of 2019 Lobby joined CBIS to start working on a project evaluating the performance of hand amputees in activities of daily living, supervised by Dr Angela Kedgley. The objective is to try and quantify the performance of hand prosthetics and understand how they impact quality of life.



**Zepur Kazezian** joined CBIS in June 2019 as a postdoctoral researcher in Professor Anthony Bull's group. Zepur is developing a model of heterotopic ossification related to blast injuries. Zepur came to Imperial to work in Professor Bull's group as the Group Manager, and before that she completed her PhD at the National University of Ireland, Galway. The title of her PhD project was 'Investigating the effect of anti-inflammatory hyaluronic acid towards regenerating the annulus fibrosus'.

## From PhD student to Postdoctoral Researcher



**Matthew Hopkins** completed his CBIS PhD entitled "Smart sockets for lower limb prosthetics" in February 2019 and moved straight into a postdoc position, remaining within Professor Alison McGregor's group. Matthew continues to build on his sensors work as a postdoctoral researcher.

## Professional Services Staff



**Cecilie Skaarup** joined CBIS as the Centre Administrator in August 2019. Cecilie joined us from the University of Copenhagen, taking over the Centre Administrator role after Amanda Wallace left in May. The Centre Administrator role involves supporting the Centre Manager and is a key point of contact for Centre members. Cecilie is involved in organising events and meetings, as well as supporting various administrative and financial processes.

## New CBIS PhD students

Five new PhD students joined the Centre in Autumn 2019 and we are delighted to have them. Below is an introduction to each of them.



**Krystyna Broda's** PhD project is focussing on cellular responses that occur following shockwave and heatwave impact that lead to heterotopic ossification in blast injury. Before joining CBIS, Krystyna worked as a Research Assistant at St. George's, University of London and completed an MSci degree at King's College London. Krystyna is supervised by Dr Claire Higgins.



**Lucas Low's** project is expanding and validating a computational rigid body model of the human spine for use in predicting the injury outcomes in the event of an underbody blast. He will then investigate the effectiveness of injury mitigation measures such as vehicle seat design. Lucas joins the Centre after finishing his MEng degree in Biomedical Engineering here at Imperial College London. Lucas is supervised by Dr Spyros Masouros and Dr Nic Newell.



**Brieuc Panhelleux** will be looking at the biomechanical differences between through-knee and above-knee amputees. Before joining the Centre, he studied for a BSc in Biomedical Sciences at King's College London and an MSc in Biomedical Engineering at Arts et Metiers ParisTech (France). Brieuc is supervised by Professor Alison McGregor and Dr Anne Silverman (Colorado School of Mines).



**Diana Toderita's** project focusses on the effect of prosthetic design on the musculoskeletal function of lower limb traumatic amputees. Prior to becoming a member of CBIS, Diana obtained for an MEng in Biomedical Engineering at Imperial College London. Diana is supervised by Professor Anthony Bull in collaboration with Dr Brad Hendershot from Walter Reed National Military Medical Center.



**Konstantinos Tsikonofilos** is working to improve the understanding of blast-induced damage in the auditory cortex at the level of neuronal circuits, and how it might affect the processing of complex auditory stimuli. Konstantinos completed an MSc in Biomedical Engineering at Imperial College London and a diploma in Applied Mathematical and Physical Sciences from the National Technical University of Athens before joining the Centre. Konstantinos is supervised by Dr Andrei Kozlov.

## PhDs awarded

We would like to congratulate the following people who successfully defended their PhD theses in 2019!

**Dr Octave Etard** – ‘EEG assessment of central auditory disorder in patients with blast-induced traumatic brain injury’ – supervised by Dr Tobias Reichenbach.

**Dr Matthew Hopkins** – ‘Smart sockets for lower limb prosthetics’ – supervised by Professor Alison McGregor.

**Dr Crispin Wiles** – ‘A structural classification of heterotrophic bone’ – supervised by Professors Alison McGregor and Anthony Bull and Dr Richie Abel.

## Leavers

We bid a very fond farewell to a few Centre members in 2019. We wish them all the best in their new roles and look forward to continuing to collaborate with them in the future.

**Dr Ziyun Ding** – moved to the University of Birmingham to take up a lectureship position.

**Dr Valeria Mondini** – has moved to the Technische Universität Graz.

**Dr Richard Pangonis** – joined Capco as a Technology Consultant.

**Dr Mark Steadman** – has moved to an engineering consultancy.

**Amanda Wallace** – moved to work as a medical secretary.

**Dr Crispin Wiles** – moved to Warwick University as a Senior Teaching Fellow in Anatomy.

**Dr Dan Zaharie** – has moved to Norway to work for a specialist engineering firm.

## Academic promotions

Congratulations to the following Centre academics who have received promotions during the year:

**Dr Mazdak Ghajari** – promoted to Senior Lecturer.

**Dr Angela Kedgley** – promoted to Senior Lecturer.

**Dr Tobias Reichenbach** – promoted to Reader in Sensory Neuroengineering.

## Being a Researcher in CBIS

### Dr Octave Etard – Postdoctoral Researcher

I initially studied engineering at École Centrale de Paris in France where I obtained a Masters degree. My curriculum was multidisciplinary, and I quickly became fascinated by applied mathematics and its use to analyse complex systems, and particularly one of the most intricate of them, the human brain. I thus chose to strengthen my knowledge in the field by completing an MSc in Biomedical Engineering with a specialisation in Neurotechnology at Imperial College London. I then joined CBIS as a PhD student in Dr Tobias Reichenbach's lab, working on neural correlates of speech-in-noise listening. Upon the successful completion of my PhD degree, I chose to continue my work as a post-doctoral researcher with CBIS.

Sound, and notably speech, is central to human social activities and communication. The auditory system is robust to perturbations in its mapping from sound to meaning, allowing us to routinely understand a conversation on a crowded train, or with someone speaking in a foreign accent. This feat relies on a long chain of processes, starting at the ear and extending all the way to the brain. Disruptions of these auditory pathways lead to various forms of hearing loss, which can have debilitating social consequences when impacting speech perception.

Blast exposure is destructive for the auditory system even in the absence of traumatic brain injuries. Indeed, blast waves induce stress and strain forces that cause diffuse injuries impeding neural connectivity even when no acute lesions are apparent. These can lead to difficulties understanding speech in noisy environments, whilst, in quiet, speech comprehension or sensitivity to sounds appears intact, making it arduous to diagnose.

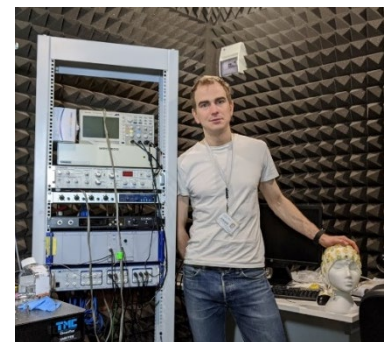

In my work, I use electroencephalography (EEG) to investigate the neural processing of speech. EEG is a non-invasive method that uses electrodes placed on the scalp to record the neural activity evoked by different stimuli. EEG allows us to simultaneously capture the responses of different stages along the auditory pathways. Ultimately this would enable us to develop methods allowing for more specific diagnosis than relying simply on the end point of the auditory chain, such as whether the stimulus was heard or not.

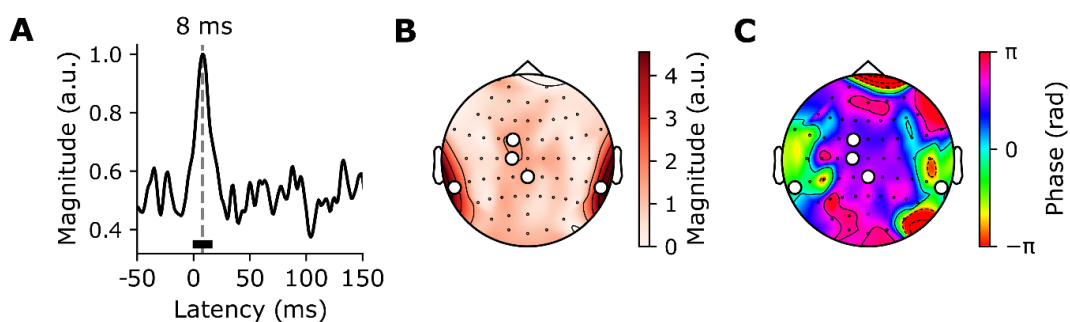

**Figure 2: Time course of the sub-cortical response to natural speech detected from high-density EEG (A), and topographical plots of amplitude (B) and phase (C). Adapted from Etard et al., *NeuroImage* (2019).**

In practice my time is split between two broad categories: acquiring data and analysing it. The former entails designing informative experiments, recruiting volunteers, and carrying out the recordings. Coming from a more analytical background, this was the most challenging part for me, and I am grateful for CBIS' support in that respect. The latter involves reviewing the current scientific literature and developing and implementing innovative data analysis pipelines.

I enjoy working at the interface between different disciplines, and CBIS, with groups tackling blast injuries from diverse perspectives, is an amazing environment to foster curiosity and collaboration. Ultimately, feeling that my work can contribute to help people is incredibly rewarding.

## Adriana Azor – Year Three PhD Student

I always thought I'd end up in medical school. I started my studies as a pre-medical student, hoping to specialize in neurology. By year 2 of my undergraduate degree, I took a summer research assistant position at Duke University in the department of paediatric neurology for 3 months. I went back again the next summer. This exposure made me realise medical school wasn't my cup of tea; research was.

I still had a strong passion for the medical field and the human brain. In October of 2016, I came to Imperial College for my MSc in Translational Neuroscience and I graduated in October 2017. During the entire academic year, I was anxious and stressed about my next move, throwing PhD applications to institutions around the world. Nothing was particularly piquing my interest, until my MSc supervisors suggested I stay at Imperial and work on a project advertised by CBIS.

My field is neuroimaging and clinical neuroscience. My PhD research at CBIS aims to understand the difference between traumatic brain injuries sustained by soldiers who have been exposed to blast in the battlefield, and non-battlefield injuries sustained by civilians under various conditions (road traffic accidents, sports injury, assault, etc.).

To develop a biomarker of blast-induced traumatic brain injury, I use advanced neuroimaging techniques such as MRI (for the structure of the brain) and diffusion MRI (for the diffusion of water molecules along the white matter tracts in the brain).

From previous work in the field, mainly in animal studies, post-mortem cases or even based on the biomechanics of blast, we hypothesized that the damage might be at the boundaries between the different tissues of the brain: white matter - corticospinal fluid and white matter - grey matter (an example is the area highlighted in red in the image below, which is the boundary between the fluid filled ventricle and a white matter area known as the corpus callosum).

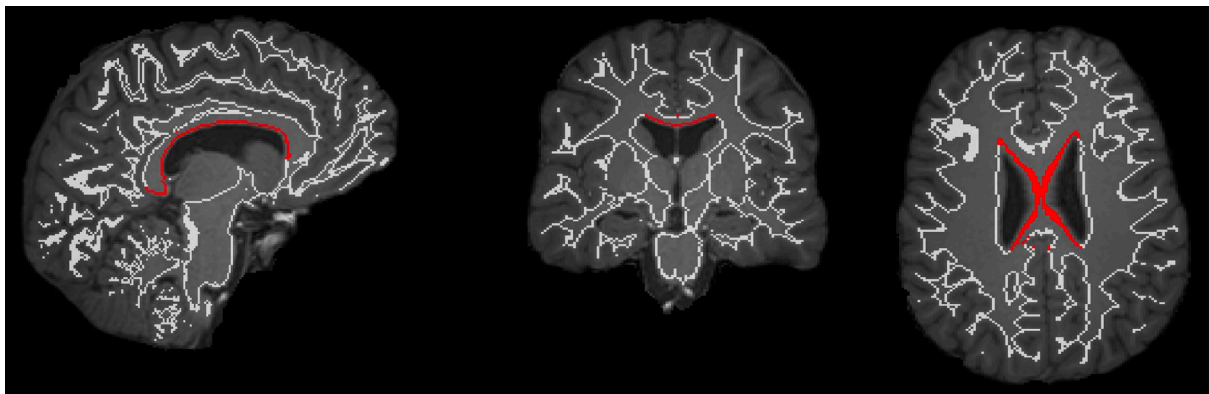

**Figure 3: The red area in these images is the boundary between the fluid filled ventricle and the corpus callosum (an area of white matter).**

With the current analysis techniques for neuroimaging studies, it is not possible to characterize tissue boundaries, especially not in diffusion imaging. Most of my work focuses on developing a new tool, that would enable researchers to carry out subject-specific analysis of very specific brain regions such as tissue boundaries, in traumatic brain injury but also in a wide variety of clinical studies. Now that my tool is ready and validated, we're waiting to see what it will reveal regarding injury patterns in our soldiers' brains.



## Alumni

### Dr Hari Arora – former Centre Research Fellow

In November 2017 I was appointed as a Senior Lecturer within the Zienkiewicz Centre for Computational Engineering (ZCCE), College of Engineering at Swansea University. The environment in South West Wales is a major contrast to life in London and after a hard day at the office, I do feel fortunate to live and work by the sea. Having spent over half of my life within walking distance of Imperial, it has been a refreshing move to a coastal university.

I worked within the Centre for Blast Injury Studies (CBIS) for 4 years, starting in the Department of Bioengineering and CBIS as a Research Fellow in November 2013. It was a highly enjoyable time, productive and transformative. I met many wonderful researchers and people in CBIS, and I continue to collaborate with members/alumni of CBIS, Bioengineering and Mechanical Engineering at Imperial. The Research Fellowship enabled me to translate my skills from Mechanical Engineering (MEng, PhD and Postdoc, 2004-2013, all at Imperial) to work in the field of trauma biomechanics. Working in the area of lung mechanics was a fascinating introduction to the world of biomechanics, receiving a crash course from Emeritus Professor Bob Schroter on Day 1. Later that year I went on to lecture lung biomechanics to final year and MSc level students within the Department, so the learning curve was steep but exciting and enjoyable. The first year in CBIS introduced me to researchers across Faculties and beyond Imperial, establishing a lung trauma network hosting several meetings to share ideas and solutions with clinicians, mathematicians, physicists and engineers from across the UK and overseas. I enjoyed the time spent on the development of experimental platforms and protocols still in use within the Centre today such as the shock tube, gas guns and various imaging and instrumentation methods. One particular highlight was overcoming logistical complications and transporting the shock tube to Diamond Light Source, which enabled us to collect the first post-blast residual mechanics measurements in lungs. It also attracted quite an audience, which briefly amused the team. I also appreciate the diverse opportunities to learn and grow as a researcher and academic such as outreach (Imperial Festival), stakeholder engagement (industry and patients), growing a new network in biomechanics and research leadership.

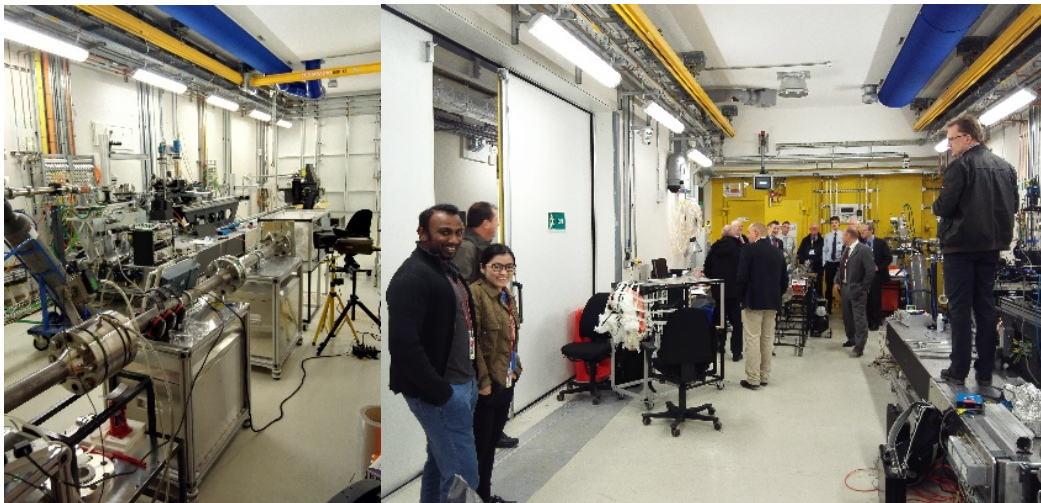

**Figure 4:** Research travels: (left) The shock tube in Branchline I13 at Diamond Light Source; (right) the first time we brought the shock tube to Diamond.

Excellent experiences and inspirational colleagues led me to pursue a new opportunity at Swansea University and build my computational research within one of the world leading computational mechanics research centres (ZCCE). I have 1 PhD student as Principal Investigator which is co-funded by industry, 3 PhDs as co-Investigator with two also co-funded by industry and multiple small grants to get research projects off the ground. Projects range from: blast injury modelling; blast evaluation and scaled

methods with multiple industrial partners; optimised armour design, manufacture and evaluation; high-rate volumetric characterisation of hard and soft tissue biomechanics; multiphysics modelling of cancer ablation in soft tissues and traumatic brain injury. A diverse list of projects with collaborators from Swansea University's College of Engineering and research groups in Sports Science, Kyushu University, Chiba University, University of Portsmouth, University of California, Diamond Light Source, SPring-8, Indian Institute of Technology Madras (IITM) and a host of industrial partners including Radnor Range Ltd., 3D Life Prints and Olympus Medical. Highlights so far include: making links with the University of Texas at Austin, Texas A&M and IITM as strategic partners with Swansea University (2018-); delivering a keynote on post-blast residual lung mechanical behaviour at the 8<sup>th</sup> World Congress of Biomechanics in Dublin (2018); becoming Admissions Tutor for Medical Engineering at Swansea University and having opportunities to share the diverse opportunities in a biomedical engineering career with the next generation (2018-); being on the organising committee for the 6<sup>th</sup> Conference in Computational and Mathematical Biomedical Engineering in Sendai, Japan (2019); working in SPring-8, Japan, as part of a Royal Society International Exchange Grant (2019); being elected conference committee co-chair for the British Society for Strain Measurement (2019-); moving into the new IMPACT Institute, a new building with flexible lab space for facilitating industry engagement on a range of engineering challenges (2019); hearing from my old Masters and PhD students even in this relatively early stage of my career; having multiple opportunities to discuss a wide range of engineering challenges with colleagues and collaborators near and far. I have already welcomed a couple of CBIS and Imperial alumni to Swansea and if you are considering a visit, you are most welcome. I am still in touch Dr Spyros Masouros and Dr Claire Higgins and others regarding upcoming joint projects/proposals, so I hope to see you all again very soon.



**Figure 5:** Research travels: (left) in the control room at SPring-8 collecting lung images in health and disease; (centre) with my collaborator, Prof Sera from Kyushu University, the day we finished at SPring-8, visiting Himeji Castle; (right) one of Prof Tanaka's research students teaching me the fine art of cooking Monjayaki in Tokyo on my last day working at Chiba University.

## Exemplar Research Findings

The following pages provide short overviews of some of the Centre's publications from 2019. These are given as examples of the breadth of work being undertaken within the Centre. We hope you enjoy reading about these research endeavours.

These papers represent a fraction of the work that our researchers are doing as many researchers are also working on projects outside of CBIS. Some of the associated projects are mentioned in the grants section on page 51.



## Micromotion and push-out evaluation of an additive manufactured implant for above-the-knee amputees

Barnes SC, Clasper JC, Bull AMJ, Jeffers JRT (2019)  
*Journal of Orthopaedic Research*, 37(10): 2104-2111

Although above-knee amputations are more common than through-knee amputations, the comparative outcomes for above-knee amputees are poor. Work in the UK military and elsewhere is applying percutaneous implants, where high stiffness intramedullary rods are used for skeletal fixation; this facilitates a highly effective connection between the prosthesis and the bone. However, these can have significant risks including infection, femoral fractures, and bone resorption due to stress shielding. The outcomes for above-knee amputees are relatively poorer due to socket fitting, pressure sores, and the lack of direct load transfer through the end of femur. On-going work in CBIS is developing a 'femoral bone plug' that enables this load transfer to take place.

This study details the physical testing of our short, cortical bone stiffness-matched subcutaneous implant, the 'bone plug', produced using additive manufacture, to determine bone implant micromotion and push-out load. In comparison to a solid control, the stiffness-matched implant exhibited significantly higher micromotion distributions and no significant difference in terms of push-out load. These results suggest that, for the stiffness-matched implant at time zero, osseointegration would be facilitated and that the implant would be securely anchored. For these metrics, this provides justification for the use of a short-stem implant for transfemoral amputees in this subcutaneous application.

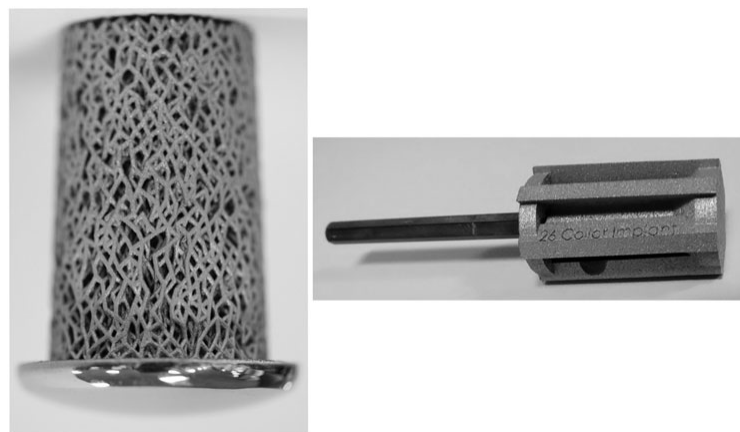

Figure 6: Stiffness-matched femoral bone plug and custom reamer for surgical implantation

### Converting an above knee amputation to enable distal end bearing

- Above-knee amputations have inferior outcomes to through-knee amputations.
- Direct skeletal fixations offer a benefit to above-knee amputees, with significant risks.
- Femoral bone plugs would improve load transfer to enable distal end bearing and so improve outcomes for above-knee amputees.
- A femoral bone plug designed at CBIS has been shown to be able to transmit load efficiently and maintain appropriate micromotion to enable bone ingrowth and good fixation.

## Xenon improves long-term cognitive function, prevents loss of cerebral white matter and improves survival after traumatic brain injury in mice

Campos-Pires R, Hirnet T, Valeo F, Ong BE, Radyushkin K, Saville J, Aldhoun J, Edge C, Franks NP, Thal SC, Dickinson R (2019)

*British Journal of Anaesthesia*, 123(1):60-73

Traumatic brain injury (TBI) is a significant healthcare issue in both military personnel and civilians. Those that survive a TBI in early adulthood frequently experience cognitive impairments later in life and have an increased risk of developing dementia and other neurodegenerative conditions. TBI survivors have an increased risk of premature death compared to those without a brain injury. The aim of the study was to determine whether treatment with the noble gas xenon for 3 hours, shortly after a TBI, would improve very long-term cognitive function and survival following TBI in mice. This study showed that xenon treatment prevented very late-onset TBI-related memory impairment and improved survival after TBI.

The effect of xenon treatment in brain areas involved in cognitive function and memory were investigated. Xenon treatment prevented chronic white matter loss in the corpus callosum, loss of neurons in the hippocampus and neuroinflammation in the amygdala and hypothalamus. This translational study suggests that xenon should be evaluated in human TBI patients.

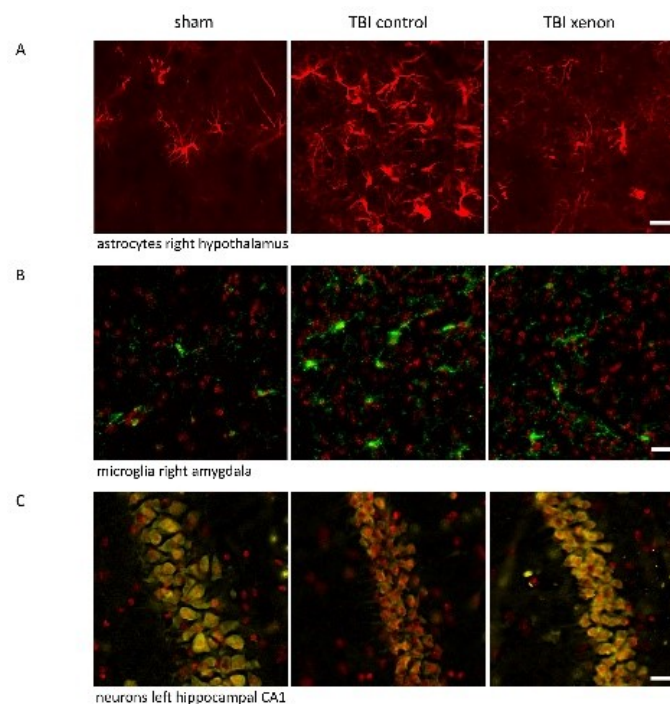

**Figure 7: Xenon prevents neuronal loss and neuroinflammation 20 months after TBI. A) Compared to the sham group the TBI control group exhibited reactive astrocytosis (red) in the hypothalamus that was absent in the TBI xenon group. B) The TBI control group had an increase in inflammatory microglia (green) that was absent in TBI xenon group. C) There was neuronal loss (yellow) in the hippocampus of the TBI control group. Xenon treatment prevented this neuronal loss.**

### Xenon exhibits very long-term neuroprotection and improves survival in mice

- Short-term treatment with xenon after TBI prevents late-onset cognitive impairment.
- Xenon treatment prevents chronic neuroinflammation and neurodegeneration after TBI.
- Xenon treatment improves long-term survival following TBI.
- These findings suggest that xenon may provide long-term benefit after TBI in humans.

## Injury risk of interphalangeal and metacarpophalangeal joints under impact loading

Carpanen D, Kedgley AE, Shah DS, Edwards DS, Plant DJ, Masouros SD (2019)  
*Journal of the Mechanical Behavior of Biomedical Materials*, 97:306-311

Injuries to the metacarpophalangeal (MCP) and proximal interphalangeal (PIP) joints of the hand are particularly disabling. However, current standards for hand protection from blunt impact are not based on quantitative measures of the likelihood of damage to the tissues. The aim of this study was to evaluate the probability of injury of the MCP and PIP joints of the human hand due to blunt impact. Impact testing was conducted on 21 fresh-frozen cadaveric hands. All hands were imaged and dissected post-impact to quantify injury. An injury-risk curve was developed for each joint with impact force as the predictive variable (Figure 8). The injury risks for PIP joints were similar, as were those for MCP joints. The risk of injury of the MCP joints from a given applied force was significantly greater than that of the PIP joints. The proposed injury curves can be used for assessing the likelihood of tissue damage, for designing targeted protective solutions such as gloves, and for developing more biofidelic standards for assessing these solutions.

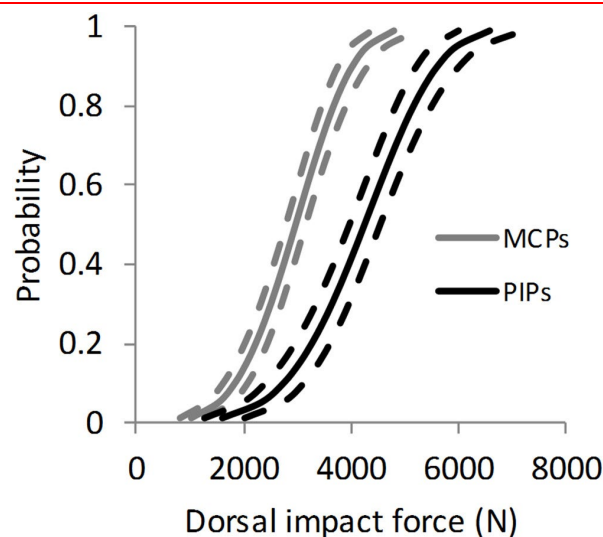

**Figure 8: Injury curves for all metacarpophalangeal (MCP) and proximal interphalangeal (PIP) joints combined. Dotted lines indicate 95% confidence intervals.**

The aim of the study was to evaluate the probability of injury of the MCP and PIP joints of the human hand due to blunt impact. Results of this study have been used by Rheon Labs to design and manufacture novel impact protection gloves for military personnel. These results can be used to define the technical specification in the tender for the next military glove requirement.

### Injury risk prediction for the hand knuckles

- The small (metacarpophalangeal (MCP) and proximal interphalangeal (PIP)) joints of the fingers were impacted in the lab to recreate blunt trauma.
- The risk of fracture of these joints was quantified.
- The PIP joints were found to be stronger than the MCP joints.
- These results have informed glove design and may inform the technical requirement of the next tender for military glove procurement.

## Improving musculoskeletal model scaling using an anatomical atlas: the improvement of gender and anthropometric similarity to quantify joint reaction forces

Ding Z, Tsang C, Nolte D, Kedgley AE, Bull AMJ (2019)  
*IEEE Transactions on Biomedical Engineering* 66(12): 3444-3456

The accuracy of a musculoskeletal model relies heavily on the implementation of the underlying anatomical dataset. Linear scaling of a generic model, despite being time and cost-efficient, produces substantial errors as it does not account for gender differences and inter-individual anatomical variations. The hypothesis of this study is that linear scaling to a musculoskeletal model with gender and anthropometric similarity to the individual subject produces similar results to the ones that can be obtained from a subject-specific model. A lower limb musculoskeletal anatomical atlas was developed consisting of ten datasets derived from magnetic resonance imaging of healthy subjects and an additional generic dataset from the literature. Predicted muscle activation and joint reaction force were compared with electromyography and literature data. Regressions based on gender and anthropometry were used to identify the use of the atlas. The results showed that joint reaction force differences at the ankle, knee and hip were reduced by between 50% and 67% when using a musculoskeletal model with the same gender and similar anthropometry in comparison with a generic model. Linear scaling with gender and anthropometric similarity can improve joint reaction force predictions in comparison with a scaled generic model.

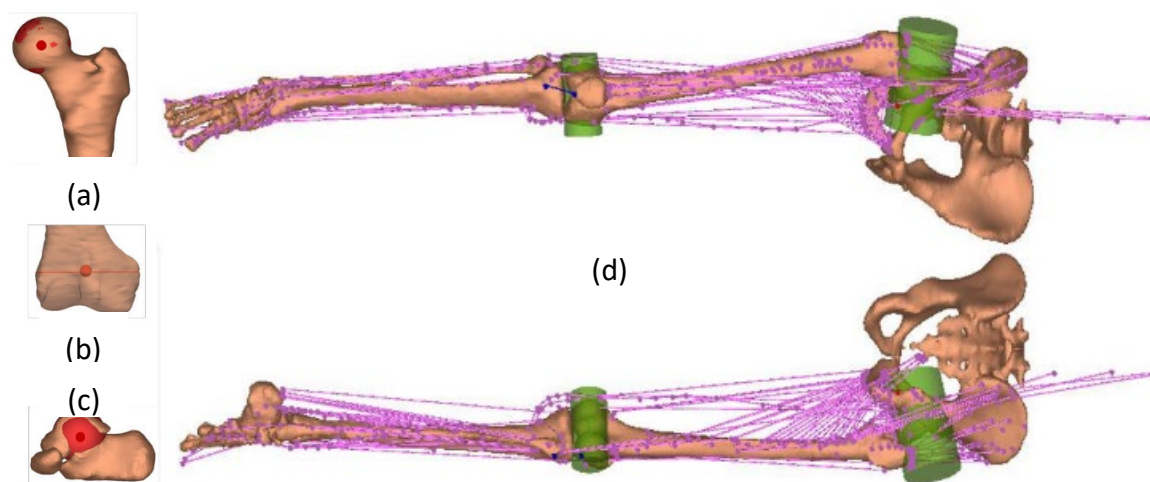

**Figure 9: Lower limb anatomy geometry for a representative subject. (a) Hip centre (b) Knee centre and knee axis (c) Ankle centre; (d) Muscle element lines-of-action (in pink) and patella ligament (in blue). Wrapping objects (in green) were defined for iliopsoas and gastrocnemius.**

The scaling approach and atlas presented can improve the fidelity and utility of musculoskeletal models for subject-specific applications. This approach will now be used to scale datasets for amputee musculoskeletal models that will likely have a greater anatomical variability.

### Scaling musculoskeletal models using an anatomical atlas

- Musculoskeletal modelling enables the calculation of muscle and joint forces.
- Musculoskeletal models require a fidelic representation of the anatomy; anatomy varies between individuals.
- The anatomical atlas developed here has been shown to allow accurate personalised models to be developed; this opens the way for similar models to be developed for amputees.

## Advanced functional bracing in lower extremity trauma: Bracing to improve function

Franklin N, Hsu JR, Wilken J, McMenemy L, Ramasamy A, Stinner DJ (2019)  
*Sports Medicine and Arthroscopy Review*, 27(3):107-111

There are many bracing options for patients with functional limitations of the lower extremity following trauma. The first question that the provider must ask when evaluating a patient with a foot and ankle functional limitation because of weakness or pain is, "what are the patient's expectations?" One option for the patient who desires to return to a higher level of function is a novel, custom dynamic orthosis (CDO) that, when coupled with an advanced rehabilitation programme, has improved outcomes in patients following lower extremity trauma who have plateaued after traditional rehabilitation pathways. Although this CDO and rehabilitation programme has demonstrated success following lower extremity trauma in heterogenous patient populations, research is ongoing to identify both ideal referral diagnoses or injury characteristics, and to further optimize outcomes with the use of the CDO. Patients with nerve injuries at or proximal to the knee can benefit from an integrated rehabilitation programme combined with a CDO with the benefit best reflected in patient reported outcomes.

This augmentation to rehabilitation continues to be investigated in a blast injury population to improve outcomes and return to service.

This work attempted to delineate in a heterogenous patient group those who gain benefit from the prescription of a CDO. Ongoing work is required to provide an evidence base and clinical decision tool for ongoing prescription.



Figure 10: A Custom Dynamic Orthosis (CDO), the Intrepid Dynamic Exoskeletal Orthosis (IDEO).

### Bracing to improve function

- A custom-dynamic orthosis (CDO) is a useful augmentation to a rehabilitation programme following nerve injury at, or proximal to the knee.
- Outcome is best reflected in improved patient reported outcomes.
- Ongoing work is required to provide a clinical decision tool for the heterogenous population.

## Lower limb posture affects the mechanism of injury in under-body blast

Grigoriadis G, Carpanen D, Webster CE, Ramasamy A, Newell N, Masouros SD (2019) *Annals of Biomedical Engineering*, 47(1):306-316

The ‘deck-slap’ foot, a product of the vehicle’s floor rising rapidly when attacked by a mine to injure the limb, has been a signature injury in recent conflicts. Given the frequency and severity of these combat-related extremity injuries, they have caused the greatest number of disabled soldiers during recent conflicts. Most research efforts focus on occupants seated with both tibia-to-femur and tibia-to-foot angles set at 90°; it is unknown whether results obtained from these tests are applicable when alternative seated postures are adopted. To investigate this, lower limbs from anthropometric testing devices (ATDs) and post mortem human subjects (PMHSs) were loaded in three different seated postures using an under-body blast injury simulator. Using metrics that are commonly used for assessing injury, such as the axial force and the revised tibia index, the lower limb of ATDs were found to be insensitive to posture variations while the injuries sustained by the PMHS lower limbs differed in type and severity between postures. This suggests that the mechanism of injury depends on the posture and that this cannot be captured by the current injury criteria.

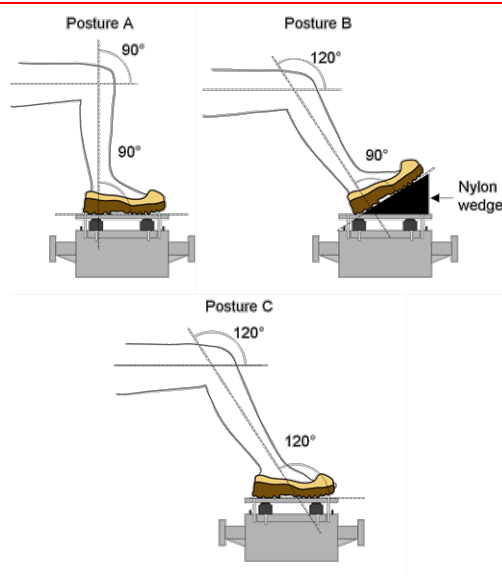

**Figure 11: The three seated postures examined in this study; Posture A (90°-90°), Posture B (120°-90°), Posture C (120°-120°).**

ID	Lower limb	Posture	AIS+2	FASS	Fracture locations	Type of fracture
1	Right	90°-90°	No	-	-	-
2	Left	90°-90°	Yes	4	Calcaneus	Sanders IV
3	Right	90°-90°	Yes	4	Calcaneus	Sanders IV
4	Left	120°-90°	No	-	-	-
5	Left	120°-90°	Yes	4	Calcaneus	Tongue
6	Left	120°-90°	Yes	6	Distal tibia & Calcaneus	AO/OTA 43C3 Sanders I
7	Left	120°-120°	No	3	Calcaneus	Sanders I
8	Right	120°-120°	Yes	6	Distal tibia	AO/OTA 43C3
9	Left	120°-120°	Yes	6	Distal tibia	AO/OTA 43C3
10	Left	120°-120°	Yes	6	Distal tibia	AO/OTA 43C3

**Table 1: Summary of all recorded fractures and their classification.**

The aim of the study was to investigate whether the posture of the lower limb of the occupant affects the injurious outcome in under-body blast, and it does. Future work is focused on the development of posture-specific injury risk functions that can accurately predict the possibility of injury in under-body blast taking lower limb posture into account.

### Plantar flexion of the ankle joint leads to distal tibia fractures in under-body blast

- The posture of the lower limb affects the injury mechanism in under-body blast.
- Posture C (120°-120°) leads to fractures of higher severity than the normally tested Posture A (90°-90°).
- Current injury risk functions and anthropometric testing devices are not valid for assessing injury in postures other than Posture A (90°-90°).



## Noble gas neuroprotection: xenon and argon protect against hypoxic-ischemic brain injury *in vitro* via different mechanisms, while helium, neon and krypton are without effect

Koziakova M, Harris K, Edge CJ, Franks NP, White IL, Dickinson R (2019)  
*British Journal of Anaesthesia*, 123(5): 601-609

Brain injuries resulting from hypoxia-ischemia are a leading cause of death and disability throughout the world. Survivors of hypoxic-ischemic brain injury frequently have long-term disability resulting in long-term care and rehabilitation costs. There are currently no treatments specifically targeting neuronal cell death following ischemia. There is interest in noble gases as treatments for ischemic and traumatic brain injury. Attention has focused on xenon that has already undergone clinical trials for hypoxic-ischemic encephalopathy in neonates and brain injury after out-of-hospital cardiac arrest in adults. However, there is also interest in argon and helium that have been evaluated in *in vitro* and *in vivo* models. This study investigated the efficacy and mechanism of the series of inert gases helium, neon, argon, krypton & xenon in an *in vitro* model of hypoxia-ischemia. Only xenon and argon were neuroprotective. Xenon and argon were equally effective, but act via different mechanisms. These findings will prompt translational studies with these two noble gases as neuroprotectants, either alone or in combination.

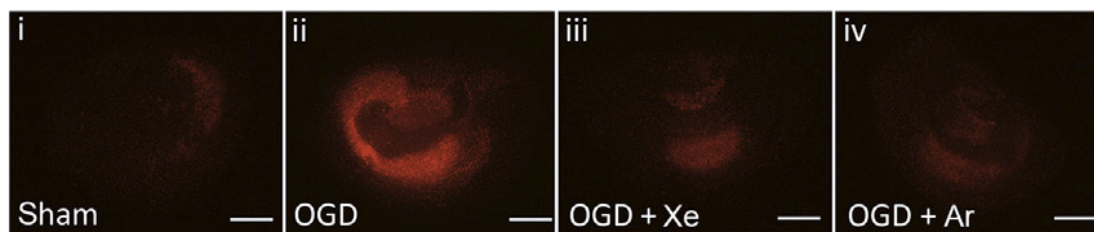

Figure 12: Xenon and argon prevent injury after oxygen glucose deprivation (OGD) whereas other noble gases have no protective effect. Typical propidium iodide fluorescence images of slices (i) sham, (ii) OGD + 0.5 atm helium, (iii) OGD + 0.5 atm xenon, (iv) OGD + 0.5 atm argon. Scale bars are 500  $\mu\text{m}$ .

### Xenon and argon protect against ischemic brain injury *in vitro* via different mechanisms

- Noble gases have shown neuroprotective effects in experimental models of reduced blood flow to the brain.
- An *in vitro* model of reduced blood flow was used to compare the neuroprotective efficacy of the full series of noble gases.
- Xenon and argon were similarly neuroprotective, but helium, neon, and krypton were without a protective effect.
- Xenon and argon act via distinct protective mechanisms.
- Further translational studies to evaluate these two noble gases as neuroprotectants are warranted by these findings.

## Passive-dynamic ankle-foot orthosis improves medium-term clinical outcomes after severe lower extremity trauma

Ladlow P, Bennett N, Phillip R, Dharm-Datta S, McMenemy L, Bennett AN (2019)  
*The Journal of the Royal Army Medical Corps*, 165(5):330-337

Individuals with delayed below-knee amputation have previously reported superior clinical outcomes compared with lower limb reconstruction. The UK military have since introduced a passive-dynamic ankle-foot orthosis (PDAFO) into its rehabilitation care pathway to improve limb salvage outcomes. The aims were to determine if wearing a PDAFO improves medium-term clinical outcomes and what influence does multidisciplinary team (MDT) rehabilitation have after PDAFO fitting? Also, what longitudinal changes in clinical outcomes occur with MDT rehabilitation and how do these results compare with patients with previous lower extremity trauma discharged prior to PDAFO availability?

Levels of mobility, activities of daily living, anxiety, depression and pain were retrospectively evaluated in a heterogeneous group of 23 injured UK servicemen 34±11 months after PDAFO provision. Sixteen patients were also retrospectively analysed across four time points (pre-PDAFO provision, first, second and final inpatient admissions post-PDAFO provision) using identical outcome measures, plus the 6 min walk test. Outcomes were compared with previous below-knee limb salvage and amputees. Before PDAFO, 74% were able to walk and 4% were able to run independently. At follow-up, this increased to 91% and 57%, respectively. Mean depression and anxiety scores remained stable over time ( $p>0.05$ ). After 3 weeks, all patients could walk independently (pre-PDAFO=31%). Mean 6 min walk distance significantly increased from 440±75m (pre-PDAFO) to 533±68m at last admission ( $p=0.003$ ). The ability to run increased from 6% to 44% after one admission. All functional and most psychosocial outcomes in PDAFO users were superior to previous limb salvage and comparable to previous below-knee amputees. The PDAFO facilitated favourable short-term and medium-term changes in all clinical outcome measurements.



**Figure 13: The Bespoke Offloading Brace (BOB) or Momentum® a Passive Dynamic Ankle Foot Orthosis (PDAFO).**

This work provides the first documented outcomes of the PDAFO in a UK population with comparisons to outcomes prior to the introduction of the orthosis. This work lays the groundwork for further work at the Centre on patient reported outcomes and the development of a clinical decision tool for prescription of the PDAFO.

### Bracing to improve function

- A passive-dynamic ankle-foot orthosis (PDAFO) is a useful augmentation to a rehabilitation programme following complex foot and ankle injuries, common in in-vehicle blast, at mean 34 months follow up.
- Outcome is best reflected in improved ability to run and improvements in walking distances.
- Ongoing work is required to provide a clinical decision tool for the heterogenous population.



## Mechanical function of the nucleus pulposus of the intervertebral disc under high rates of loading

Newell N, Carpanen D, Evans JH, Pearcy MJ, Masouros SD (2019)  
*Spine*, 44:1035-1041

The mechanical function of the gelatinous nucleus pulposus (NP) located in the centre of the intervertebral discs (IVDs) of the spine is unclear. Removal of the NP has been shown to affect the direction of bulge of the inner anulus fibrosus (AF), but at low loading rates removal of the NP pressure does not affect the IVD's stiffness. During blast related injurious events, IVDs are commonly exposed to high loading rates, however, no studies have investigated the mechanical function of the NP at these rates. Here, bovine motion segments were used to investigate the high-rate compression response of intervertebral discs before and after depressurising the nucleus pulposus (NP) by drilling a hole through the cranial endplate into it. The hole caused a 28.5% drop in the NP pressure but no statistically significant difference was seen in peak force, peak displacement, or energy-absorption of the intact, and depressurized NP groups under impact loading. The IVDs absorbed 72% of the input energy, and there was no rate dependency in the percentage energy absorbed. These results demonstrate that the NP pressure does not affect the transfer of load through, or energy absorbed by, the IVD at high loading rates and the AF, rather than the NP, may play the most important role in transferring load, and absorbing energy at these rates. This should be considered when attempting surgically to restore IVD function.

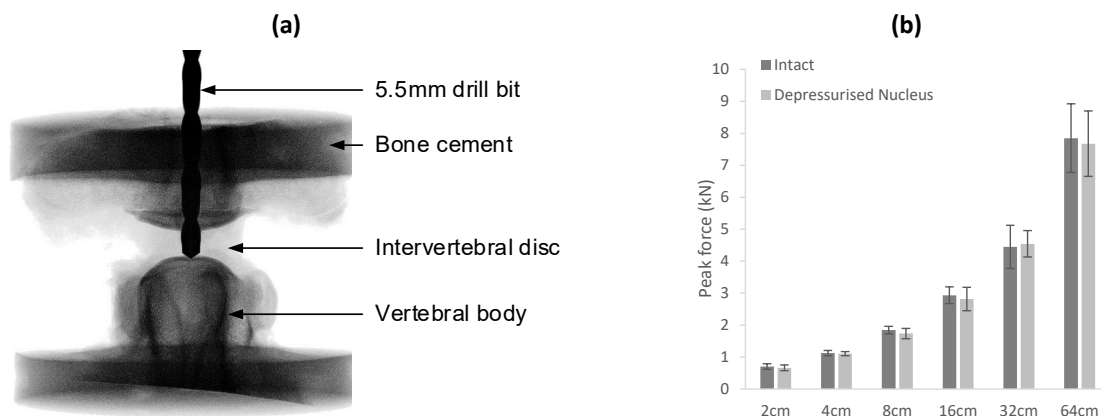

**Figure 14: (a) Fluoroscope image of one of the samples with a 5.5 mm hole drilled through the cranial vertebra and endplate, into the nucleus pulposus. (b) Comparison between the average peak force of the intact samples and the depressurized nucleus pulposus (NP) samples. No significant differences were seen between the intact and depressurized NP groups.**

The aim of this paper was to investigate the effect of depressurising the NP on the force-displacement response, and the energy absorption in IVDs when compressed at high strain rates, such as experienced in blast.

### Nucleus pulposus function at high rates

- Under impact loading, no difference was seen in peak force, peak displacement, or energy-absorption of intact motion segments (vertebral body – disc – vertebral body) and motion segments with a depressurised nucleus pulposus (the nucleus is the inner gel-like substance of the intervertebral disc in the spine).
- The pressure of the nucleus pulposus does not affect the transfer of load through, or energy absorbed by, the intervertebral disc at high loading rates.
- The anulus fibrosus, rather than the nucleus pulposus, may play the most important role in transferring load, and absorbing energy at high loading rates.

## Blast injuries in children: a mixed-methods narrative review

*Milwood Hargrave J, Pearce PA, Mayhew ER, Bull AMJ, Taylor S (2019)  
BMJ Paediatrics Open, 3(1): 3*

The Centre for Blast Injuries Studies is committed to ensuring that its learning from military blast is translated to the civilian domain. Blast injuries arising from high explosive weaponry is common in conflict areas and disproportionately affects civilians, and children, in particular. The military frequently treat these civilians. While blast injury characteristics are well recognised in adults, there is a lack of consensus as to whether these characteristics translate to the paediatric population. Understanding blast injury patterns in this cohort is essential for providing appropriate provision of services and care for this vulnerable cohort.

This study was a mixed-methods review that sought to capture what is known about paediatric injuries following blasts. Information on demographics, morbidity and mortality, and service requirements were evaluated.

The findings are clear: children affected by blast injuries are predominantly male and their injuries arise from explosive remnants of war, particularly unexploded ordinance; blasts show increased morbidity and mortality in younger children, while older children have injury patterns similar to adults; head and burn injuries represent a significant cause of mortality in young children, while lower limb morbidity is reduced compared with adults; and children have a disproportionate requirement for both operative and nonoperative service resources, and provisions for this burden are essential.

The old moniker that children are small adults does not hold true. Certain characteristics of paediatric injuries arising from blasts are distinct from that of the adult cohort, while the intensive demands on services highlight the importance of understanding the diverse injury patterns in order to optimise future service provisions in caring for this child blast survivor.

### Blast injuries in children are different to those in adults

- Children are disproportionately affected by blast with increased morbidity and mortality compared to adults.
- Lower limb injuries are reduced compared to adults.
- Head and burn injuries are a significant cause of death in the blast injured child.

## Experimental platforms to study blast injury

Nguyen TT, Pearce AP, Carpanen D, Sory D, Grigoriadis G, Newell N, Clasper J, Bull A, Proud WG, Masouros SD (2019)

*Journal of the Royal Army Medical Corps*, 165(1): 33-37

Injuries sustained due to attacks from explosive weapons are multiple in number, complex in nature, and not well characterised. Blast may cause damage to the human body by the direct effect of overpressure (primary-blast injury), penetration by highly energised fragments (secondary-blast injury), and blunt trauma by violent displacements of the body (tertiary-blast injury). The ability to reproduce the injuries of such insults in a well-controlled fashion is essential for understanding the mechanism by which they occur, and designing better treatment and protection strategies to alleviate the resulting poor long-term outcomes. This paper reports a range of experimental platforms that have been developed for different blast-injury models, their working mechanism, and main applications. These platforms include the shock tube, split-Hopkinson bar, the gas gun, drop towers, and underbody blast simulators.

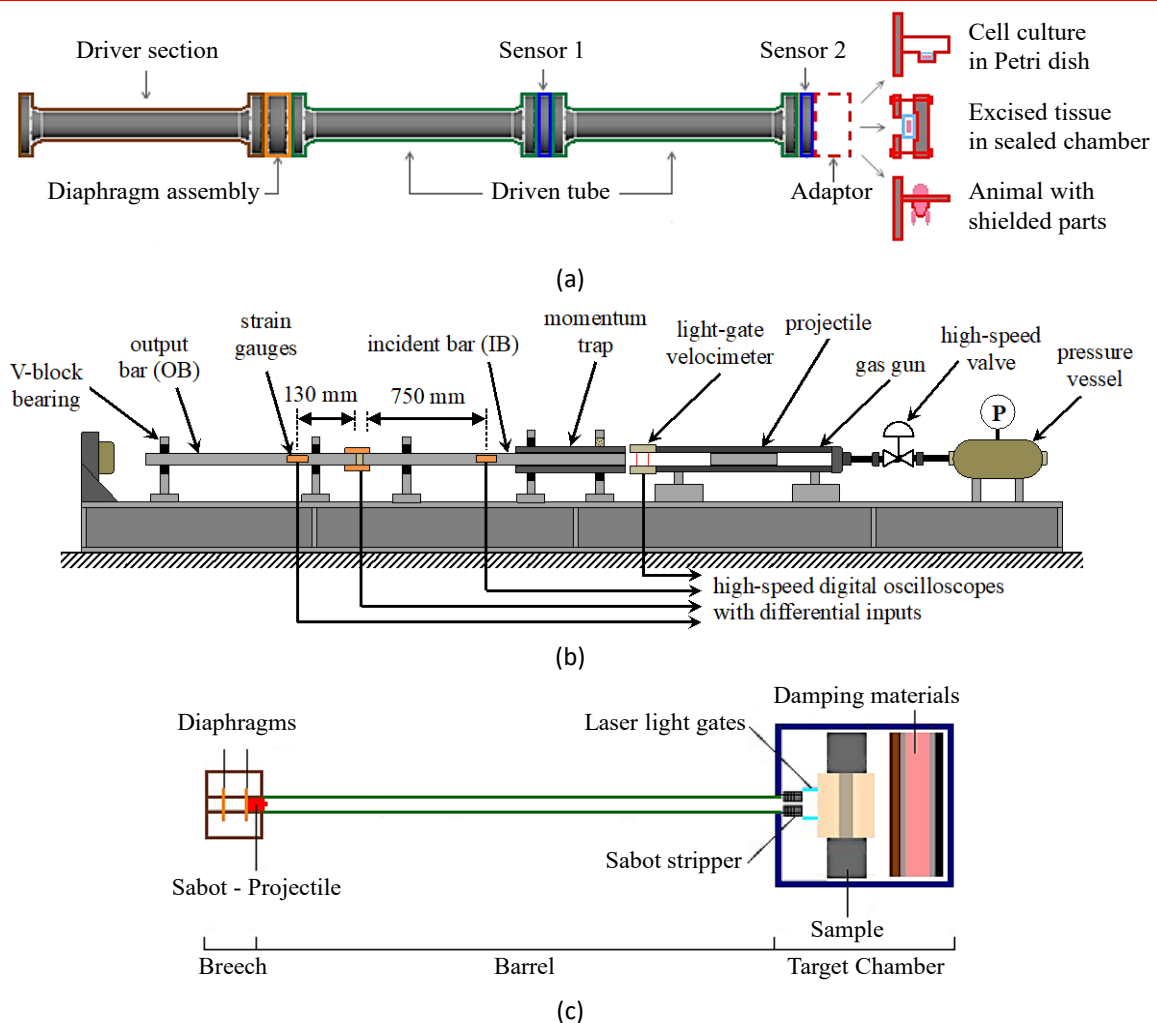

**Figure 15: Diagrammatic representation of experimental platforms to study blast injury; (a) the shock tube, (b) the split-Hopkinson pressure bar, and (c) the gas gun.**

### Experimental platforms for blast injury

- A range of experimental platforms is essential to recreate the various blast-injury mechanisms.
- The versatility of experimental devices allows adaptation for *in vivo*, *ex vivo*, and *in vitro* experimental models of blast injury.
- The relevance, design, build, and translation of these experimental platforms requires interdisciplinary collaboration between science, engineering and medicine.

## Platform development for primary blast injury studies

Nguyen T-T, Sory DR, Amin HD, Rankin SM, Proud WG (2019)  
*Trauma*, 21(2):141-146

Primary blast injuries are critical injuries often inflicted on victims in the proximity to the explosion. They are caused by rapid pressure changes in the blast wave, which result in severe compression and shearing in the tissue of gas-filled and liquid-filled organs such as the lungs, ears, and vessels. These injuries have complex pathophysiology and their injury mechanisms are not well-understood. In order to study the acute and long-term damages by the primary blast effects to different tissues, it is essential to develop well-characterised experimental platforms which can replicate realistic soft tissue traumas and induce the molecular response of cells under dynamic mechanical loadings similar to those of the blast waves.

The shock tube is a versatile device for observing the overall primary blast effects on a biological system, where the pressure loading can be tailored to match different blast scenarios (Figure 16a). Various methods of pulse shaping can allow for reproduceable and realistic blast wave generation providing a reliable approach to compare between different studies. The system can be adapted to investigate blast injuries in biological samples of different scales such as the inflammation in *in vivo* rodent limbs, damages in *ex vivo* respiratory organ culture, and responses of *in vitro* monolayer stem cell culture. On the other hand, dynamic loading devices such as the drop-weight rigs and the split-Hopkinson pressure bar (SHPB) are employed to study the mechanical effects across a range of specific strain rates, from  $10$  to  $10^3 \text{ s}^{-1}$  with single or multiple pulses, relevant to primary blast loading. These platforms can be modified to exert individual mechanical features of real blast wave on monolayer or 3D-scaffolding cell culture systems. Such applications are used to assess the change in cell viability and the osteogenesis in response to varying strain rate mechanical stimuli (Figure 16b).

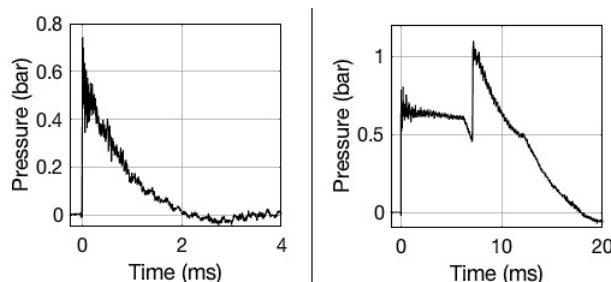

Figure 16a: Examples of output blast waves generated by the shock tube system.

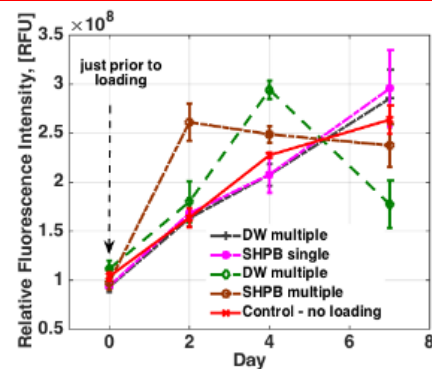

Figure 16b: Cell health assessment in response to single or multiple loading by the SHPB and the drop-weight (DW).

This paper discusses the replication of primary blast effects using modified experimental devices. The blast-specific platform development addressing different length scales (musculoskeletal to cells and subcellular components) enables us to investigate the physical forces associated with blast trauma and the downstream effects on cells and tissues. The ability to generate real, complex blast loadings in a controlled laboratory environment will help to identify the mechanotransduction associated with primary blast injuries and thus address targeted treatments for related pathologies.

### Platforms for primary blast injury studies

- Well-characterised experimental platforms replicating realistic blast loadings are essential to study primary blast injuries.
- The shock tube can model the overall primary blast effects of different loading scenarios.
- Drop-weight rigs and SHPB can provide dynamic loading of specific blast-relevant strain rate to study the mechanical response of different cell culture systems.

## Improving survivability from blast injury: 'shifting the goalposts' and the need for interdisciplinary research

*Pearce AP, Clasper J (2019)*

*The Journal of the Royal Army Medical Corps, 165(1):5-6*

This was the editorial introducing the Blast Special Edition of the Journal of the Royal Army Medical Corps, which CBIS had a major role in contributing to. The editorial summarises the papers and commented on the need to reconsider existing trauma scoring systems.

Traditionally, mathematical scoring systems based on previously treated casualties have been used to assess the risk of death following injury. As such they are retrospective in nature, and as medical advances are made and survival rates improve, all scoring systems will become inaccurate; until a stage is reached where further advances cannot improve survival rates. Further improvements in survival can then only be made with mitigation rather than treatment and this will not be detected with the scoring systems. There is also the problem of 'unsurvivable injuries'. Some will always be unsurvivable – decapitation for example – but some, particularly very high bilateral leg amputations had survival rates of 1% or less in previous conflicts, but now have survival rates above 50%, and so need to be reclassified. Therefore, as mitigation and treatment advances are made, traditional scoring systems need to be revised.

### Improving survivability from blast injury

- As medical advances are made, and survival rates improve, scoring systems will become inaccurate.
- Some injuries that were previously considered 'unsurvivable' are now survivable, and therefore need reclassification.

## Restricting lower limb flail is key to preventing fatal pelvic blast injury

Rankin IA, Nguyen TT, Carpanen D, Clasper JC, Masouros SD (2019)  
*Annals of Biomedical Engineering* 47(11):2232-2240

Pelvic vascular injury in the casualty of an explosive insult is a principal risk factor for increased mortality. The mechanism of injury has not previously been investigated in a physical model. In this study, a cadaveric small-animal model of pelvic blast injury with a shock-tube mediated blast wave was utilised and showed that lower limb flail is necessary for an unstable pelvic fracture with vascular injury to occur. One hundred and seventy-three cadaveric mice underwent shock-tube blast testing and subsequent injury analysis. Increasingly displaced pelvic fractures and an increase in the incidence of pelvic vascular injury were seen with increasing lower limb flail. Pre-blast surgical amputation at the hip or knee showed the thigh was essential to result in pelvic displacement whilst the leg was not. These findings, corroborated by clinical data, bring a paradigm shift in our understanding of the mechanism of blast injury. Restriction of lower limb flail in the human, through personal protective equipment, has the potential to mitigate the effects of pelvic blast injury.

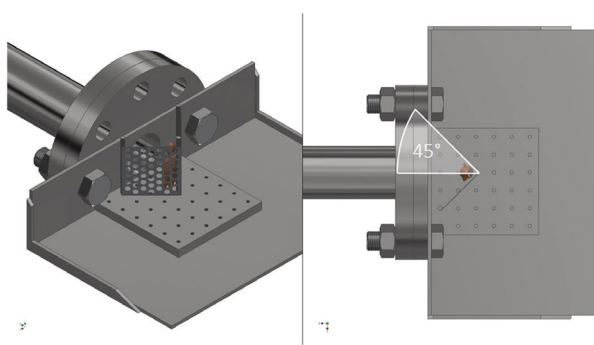

**Figure 17a: Left: Experimental setup showing shock tube with fenestrated fence used to limit lower limb flail. Right: aerial view.**

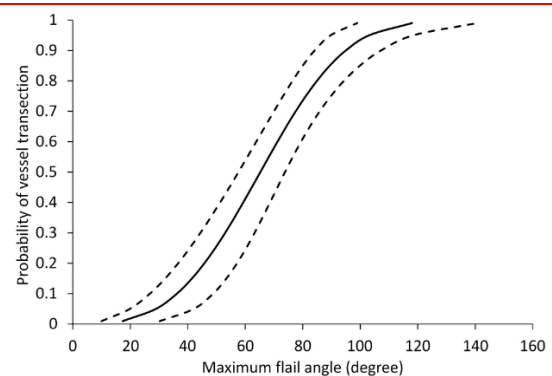

**Figure 17b: Vascular injury risk curve as a function of maximum allowable angle of lower extremity flail.**

Follow-on research has studied the effect of a reinforced, restrictive belt to limit flail in a cadaveric animal model, whilst current research is looking to translate these findings for human use.

### Lower limb flail and pelvic blast injury

- Limitation of outward flail of the lower limb reduces the incidence of pelvic vascular injury when studied in a cadaveric animal model.
- These findings determine the mechanism of injury to the lower body in dismounted blast and suggest a mitigation strategy not previously considered.
- Limitation of lower limb flail in the next generation of personal protective equipment may reduce the high mortality rates associated with dismounted pelvic blast injury.

## Individual differences in the attentional modulation of the human auditory brainstem response to speech show a non-peripheral contribution to speech-in-noise deficits

Saiz-Alia M, Forte AE, Reichenbach T (2019)  
*Scientific Reports*, 9(1):14131

People with normal hearing thresholds can have difficulty with understanding speech in noisy backgrounds. The origins of such supra-threshold hearing deficits remain largely unclear. Previously this team has shown that the auditory brainstem response to running speech is modulated by selective attention, evidencing a subcortical mechanism that contributes to speech-in-noise comprehension. However, significant variation in the magnitude of the brainstem's attentional modulation between the different volunteers was observed. This paper shows that this variability relates to the ability of the subjects to understand speech in background noise, but that it is not related to peripheral hearing impairment. In particular, 43 young human volunteers with normal hearing thresholds were assessed for their ability to understand speech in noise. Their auditory brainstem responses to running speech when selectively attending to one of two competing voices were also recorded and there was further examination of whether subjects exhibited cochlear synaptopathy, a supra-threshold hearing impairment associated with the auditory periphery, through a battery of behavioural and electrophysiological tests that assessed noise exposure, the temporal sensitivity threshold, the middle-ear muscle reflex, and the auditory-brainstem response to clicks in various levels of background noise. These tests showed only scant evidence for cochlear synaptopathy amongst the volunteers. However, even if cochlear synaptopathy was present in some subject, it related neither to the variability in the attentional modulation of the brainstem response to speech nor to the variation in speech-in-noise perception. The results therefore evidence a non-peripheral origin of the variability in speech-in-noise comprehension amongst the subjects.

Follow-up work will investigate the potential impairment of auditory-brainstem responses connected to selective attention in veterans with blast exposure.

### Brainstem response to speech and speech-in-noise comprehension

- Auditory processing disorder due to blast causes difficulty with understanding speech in noisy backgrounds.
- The auditory brainstem response is modulated by selective attention to a speaker in background noise.
- The attentional modulation of this neural response informs on a subject's ability to understand speech in noise.
- This attentional modulation does not appear to be linked to cochlear synaptopathy.



## Understanding low back pain in traumatic lower limb amputees: A systematic review

Sivapuratharasu B, Bull AMJ, McGregor AH (2019)

*Archives of Rehabilitation Research and Clinical Translation*, 1(1-2), 100007

The aim of the study was to evaluate current literature for the prevalence, causes, and effect of low back pain (LBP) in traumatic lower limb amputees, specifically its association with the kinematics and kinetics of the lumbar spine and lower extremities. There was an LBP prevalence of 52%-64% in traumatic amputees, compared to 48%-77% in the general amputee population (predominantly vascular, tumour, trauma), attributed to a mixture of biomechanical, psychosocial, and personal factors. These factors determined the presence, frequency, and severity of the pain in the amputees, significantly affecting their quality of life. However, little evidence was available on causality. The high prevalence of LBP in traumatic amputees highlights the necessity to advance research into the underlying mechanics behind LBP, specifically the spinal kinematics and kinetics.

Following on from this study, a biodynamics study is being done to test the functionality of traumatic lower limb amputees during several daily activities. The results from this study can help us understand the mechanical differences between different amputee cohorts during activities of daily living, which may facilitate improvements in rehabilitation, with the potential to improve quality of life in traumatic amputees.



**Figure 18: Image showing an amputee with the marker set for investigating the mechanical factors that could be affecting low back pain during activities of daily living.**

### Low back pain in traumatic lower limb amputees

- There is a high prevalence of low back pain in traumatic amputees.
- Direct causation of low back pain in traumatic amputees is unknown.
- Understanding the causation is required to improve quality of life.



## Fatal head and neck injuries in military underbody blast casualties

Stewart SK, Pearce AP, Clasper JC (2019)

The Journal of the Royal Army Medical Corps, 165(1):18-21

This retrospective study investigated fatal in-vehicle blast incidents in UK Armed Forces during recent operations in Afghanistan and Iraq. Head and neck injuries were classified by anatomical site into: skull vault fractures, parenchymal brain injuries, base of skull fractures, brain stem injuries and cervical spine fractures. Incidence of all injuries and of each injury type in isolation was compared.

Parenchymal brain injuries (75%) occurred most commonly followed by skull vault (55%) and base of skull fractures (32%). Cervical spine fractures occurred in only 18% of casualties. 62% of casualties had multiple sites of injury with only one casualty sustaining an isolated cervical spine fracture.

Although previous biomechanical studies have concentrated on the effect of axial load transmission and resultant injury to the cervical spine, the work in this paper demonstrates that cervical spine injuries are of limited clinical relevance for underbody blast survivability and that research should focus on severe brain injury secondary to direct head impact.



**Figure 19: Computed tomography (CT) reconstruction illustrating major cranial trauma, including a comminuted frontal bone fracture and depressed occipital bone fracture. This image typifies the magnitude of cranial trauma seen in underbody blast (UBB) casualties and is likely to be incompatible with life.**

### Fatal head and neck injuries in underbody blast

- Parenchymal brain injuries were the most common fatal head and neck injuries in under body blast.
- Research should focus on severe brain injuries secondary to direct head impact rather than cervical spine injuries in terms of clinical relevance for in-vehicle survivability.

## Environment at the time of injury determines injury patterns in pelvic blast

Webster CE, Clasper J, Gibb I, Masouros SD (2019)  
*Journal of the Royal Army Medical Corps*, 165: 15-17

The environment at the time of detonation is known to result in different injury patterns in casualties exposed to blast, which is highly relevant to injury mitigation analyses. Here, we describe differences in pelvic injury patterns in relation to different environments, from casualties that presented to the deployed UK military hospitals in Iraq and Afghanistan. A casualty on foot when injured typically sustains an unstable pelvic fracture pattern, which is commonly the cause of death. These casualties die from blood loss, meaning treatment in these should focus on early pelvic haemorrhage control. In contrast, casualties injured in-vehicle present a different pattern, possibly caused by direct loading via the seat, which does not result in pelvic instability. Fatalities in this cohort are from injuries to other body regions, in particular the head and the torso, and may require urgent neurosurgery or thoracotomy as life-saving interventions. A different mitigation and treatment strategy is therefore required for mounted compared to dismounted casualties in order to increase survivors. Experimental models of pelvic injury in-vehicle and on foot have now been developed in CBIS which aim at recreating the injury mechanism and trialling the efficacy of protective measures.

	Dismounted (n=199)		Mounted (n=126)		Pelvic injury	Mounted (n=126)	Dismounted (n=199)	P values
	Incidence (%)	Fatality rate, %	Incidence (%)	Fatality rate, %				
Lower extremity	164 (82)	44	39 (31)	25	Pubic symphysis disruption	42 (33%)	137 (69%)	<b>0.0001</b>
Head (including face, neck)	19 (10)	79	47 (37)	81	Sacroiliac joint disruption	42 (33%)	143 (72%)	<b>0.0001</b>
Thorax	10 (5)	100	26 (21)	22	Pubic ramus fracture	66 (52%)	72 (36%)	<b>0.0056</b>
Abdomen	6 (3)	75	12 (9.5)	30	Sacral fracture	40 (32%)	68 (43%)	0.7173
Upper extremity	0 (0)	0	2 (1.5)	0	Spinal fracture	58 (46%)	40 (20%)	<b>0.0001</b>
					Acetabular fracture	40 (32%)	58 (29%)	0.6221
					Traumatic amputation	33 (26%)	152 (76%)	<b>0.0001</b>

**Figure 20: (a) Main body regions injured, fatality, and environment at the time of injury. (b) Injury patterns and environment at the time of injury (values in bold indicate statistical significance).**

### Pelvic blast-injury pattern

- Pelvic injury in the mounted is stable, not fatal and likely due to vertical seat loading.
- Pelvic injury in the dismounted is unstable, fatal and likely due to limb flail.
- Different preventive measures and treatment strategies need to be employed depending on the environment in which pelvic blast-injury occurs.

# An assessment of blast modelling techniques for injury biomechanics research

Yu X, Ghajari M (2019)

*International Journal for Numerical methods in Biomedical Engineering*, 35(12): e3258

As blast wave modelling methods reported in current literature have drawbacks, this paper critically assesses the commonly used methods for simulating blast waves. The authors propose a suitable meshing topology, which enables accurate prediction of blast wave propagation and interaction with the human head and significantly decreases the computational cost in 3D simulations. The influence of the blast wave modelling methods on the brain response are shown, which can serve as guidelines for blast injury modelling and design of prevention systems.

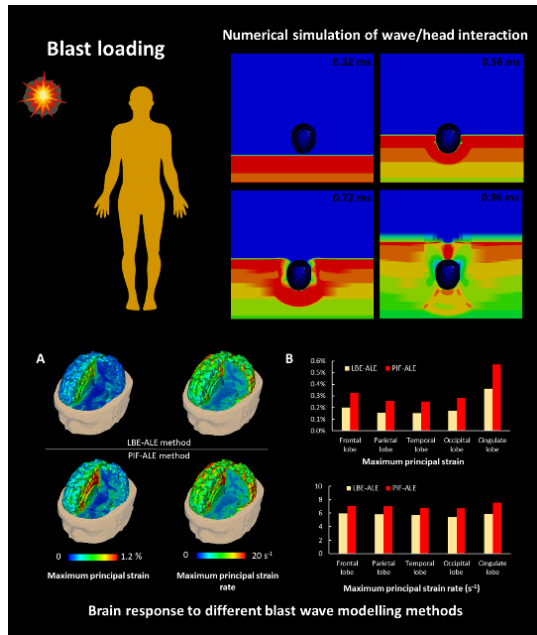

**Figure 21:** Simulation results of brain response to blast. A) Maximum strain and strain rate within the brain. B) The mean value of maximum strain and strain rate at different lobes.

Blast parameters	LBE-ALE and PIF-ALE models	MM-ALE model
TNT Charge weight (kg)	1.3	0.15
Standoff distance (m)	2.142	0.6
Incident over pressure $p_s$ (kPa)	200	713
Positive Phase Duration $t_*$ (ms)	2	0.96
Particle velocity (m/s)	293	645.4
Ambient pressure $p_{amb}$ (kPa)	101.3	101.3
Ambient temperature $T_{amb}$ (K)	293	293

**Table 2:** Blast parameters calculated with modified Kingery-Bulmash equations.

The aim of the study was to introduce three commonly used methods for simulating blast wave propagation in air (open-field blast), which have been used in previous literature. Some drawbacks in these methods are found, which have been misleading researchers. The authors introduce the implementation process of these methods with details and critically assess these methods by both comparing their predicted blast wave with ideal blast wave history and evaluating their performance on simulating wave/head interaction. The validated blast modelling method will be used to simulate blast induced traumatic brain injury (bTBI) in following studies to explore the mechanism and protection of bTBI.

## An assessment of blast modelling techniques

- The implementation process of these methods was introduced and critically assessed by firstly comparing their predicted blast wave with ideal blast wave history. Their performances on simulating human head/blast wave interaction was then evaluated.
- A new meshing topology was proposed, which enables high fidelity prediction of blast wave propagation and interaction with the human head while significantly decreasing the computational cost in 3D simulations.
- It was found that exposing the head model to blast pressure waves with similar peaks and seemingly small differences in their time histories resulted in large differences in predicted strain and strain rate in the brain.

# A comparative study of continuum and structural modelling approaches to simulate bone adaptation in the pelvic construct

Zaharie DT, Phillips ATM (2019)  
*Applied Sciences*, 9(16):3320

This paper consolidates work done by Dan Zaharie as a PhD student in CBIS. It compares a variety of continuum and structural mechanics finite element modelling approaches to predicting the bone structure of the pelvis. It compares five different predictive models to a model derived from a CT scan of the pelvis using a standard method of conversion from greyscale values to isotropic Young's modulus values. All predictive models predicted significantly less bone than that found for the CT derived model. A continuum orthotropic model gave the closest match to the CT derived model, which was not expected considering the CT derived model was isotropic (Figure 22).

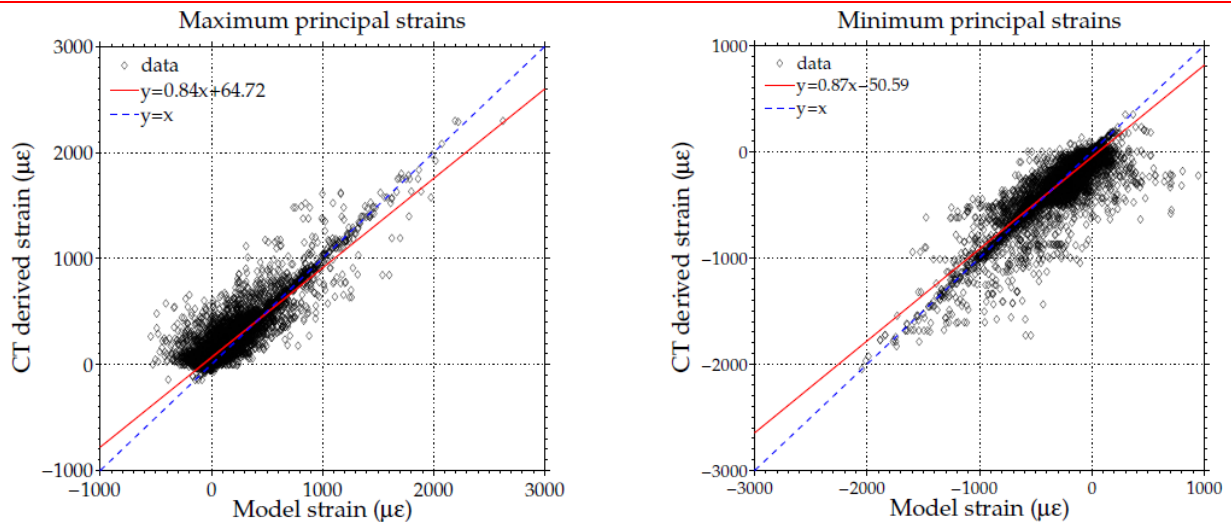

**Figure 22: Comparison of principal strains for the predicted orthotropic continuum model compared to those from a CT derived isotropic continuum model**

The aim of the study was to compare the results obtained from alternative predictive modelling approaches to those found from a CT derived model.

The results of the study suggest that further consideration should be given to the representation of skeletal structures when modelling at the extremes. Further work will look at the effect of different approaches on fracture prediction in the pelvis, including pelvic injuries sustained through blast events.

## Predictive approaches to modelling pelvic bone architecture

- Orthotropic continuum predictive modelling compares well to CT derived models.
- Inclusion of a cortical shell alters the apparent structural behaviour of the pelvis.
- CT derived models should be questioned as a gold standard.

# Appendix

## Publications

Below is a list of publications that have arisen from the work within the Centre. Journal publications are important platforms for disseminating research findings.

Barnes SC, Clasper JC, Bull AMJ, Jeffers JRT (2019). *Micromotion and push-out evaluation of an additive manufactured implant for above-the-knee amputees*. Journal of Orthopaedic Research, 37(10): 2104-2111.

Campos-Pires R, Hirnet T, Valeo F, Ong BE, Radyushkin K, Saville J, Aldhoun J, Edge C, Franks NP, Thal SC, Dickinson R (2019). *Xenon improves long-term cognitive function, prevents loss of cerebral white matter and improves survival after traumatic brain injury in mice*. British Journal of Anaesthesia, 123(1):60-73.

Carpanen D, Kedgley AE, Shah DS, Edwards DS, Plant DJ, Masouros SD (2019). *Injury risk of interphalangeal and metacarpophalangeal joints under impact loading*. Journal of the Mechanical Behaviour of Biomedical Materials, 97: 306-311.

Ding Z, Tsang C, Nolte D, Kedgley AE, Bull AM (2019). *Improving musculoskeletal model scaling using an anatomical atlas: the importance of gender and anthropometric similarity to quantify joint reaction forces*. IEEE Transactions on Biomedical Engineering, 66(12): 3444-3456.

Etard O, Reichenbach T (2019). *Neural speech tracking in the theta and in the delta frequency band differentially encode clarity and comprehension of speech in noise*. Journal of Neuroscience, 39: 5750.

Etard O, Kegler M, Braiman C, Forte AE, Reichenbach T (2019). *Real-time decoding of selective attention from the human auditory brainstem response to continuous speech*. NeuroImage, 200: 1-11.

Franklin N, Hsu JR, Wilken J, McMenemy L, Ramasamy A, Stinner DJ (2019). *Advanced functional bracing in lower extremity trauma: Bracing to improve function*. Sports Medicine and Arthroscopy Review, 27(3): 107-111.

Grigoriadis G, Carpanen D, Webster CE, Ramasamy A, Newell N, Masouros SD (2019). *Lower limb posture affects the mechanism of injury in under-body blast*. Annals of Biomedical Engineering, 47(1): 306-16.

Koziakova M, Harris K, Edge CJ, Franks NP, White IL, Dickinson R (2019). *Noble gas neuroprotection: xenon and argon protect against hypoxic-ischemic brain injury in vitro via different mechanisms, while helium, neon and krypton are without effect*. British Journal of Anaesthesia, 123(5): 601-609.

Ladlow P, Bennett N, Phillip R, Dharm-Datta S, McMenemy L, Bennett AN (2019). *Passive-dynamic ankle-foot orthosis improves medium-term clinical outcomes after severe lower extremity trauma*. Journal of the Royal Army Medical Corps, 165(5): 330-337.

Mayhew Emily, Le Feuvre Peter (2019). *The Walled Garden at Headley Court: growth and restoration after war*. SiteLINES: A Journal of Place, 15(1): 12-15.

Milwood Hargrave J, Pearce PA, Mayhew ER, Bull AMJ, Taylor S (2019). *Blast injuries in children: a mixed-methods narrative review*. BMJ Paediatrics Open, 3(1): 3.

Newell N, Carpanen D, Evans JH, Percy MJ, Masouros SD (2019). *Mechanical function of the nucleus pulposus of the intervertebral disc under high rates of loading*. Spine, 44(15): 1035-1041.

Nguyen T-T, Pearce AP, Carpanen D, Sory D, Grigoriadis G, Newell N, Clasper JC, Bull AMJ, Proud WG, Masouros SD (2019). *Experimental platforms to study blast injury*. Journal of the Royal Army Medical Corps, 165(1): 33-37.

Nguyen T-T, Sory DR, Amin HD, Rankin SM, Proud WG (2019). *Platform development for primary blast injury studies*. Trauma, 21(2): 141-146.

- Pearce AP, Clasper J (2019). *Improving survivability from blast injury: 'shifting the goalposts' and the need for interdisciplinary research*. Journal of the Royal Army Medical Corps, 165(1): 5-6.
- Rankin IA, Nguyen TT, Carpanen D, Clasper JC, Masouros SD (2019). *Restricting lower limb flail is key to preventing fatal pelvic blast injury*. Annals of Biomedical Engineering, 47(11): 2232-2240.
- Saiz-Alia M, Forte AE, Reichenbach T (2019). *Individual differences in the attentional modulation of the human auditory brainstem response to speech inform on speech-in-noise deficits*. Scientific Reports, 9(1): 14131.
- Sivapuratharasu B, Bull AMJ, McGregor AH (2019). *Understanding low back pain in traumatic lower limb amputees: A systematic review*. Archives of Rehabilitation Research and Clinical Translation, 1(1-2).
- Stewart SK, Pearce AP, Clasper JC (2019). *Fatal head and neck injuries in military underbody blast casualties*. Journal of the Royal Army Medical Corps, 165(1): 18-21.
- Yu X, Ghajari M (2019). *An assessment of blast modelling techniques for injury biomechanics research*. International Journal of Numerical Methods in Biomedical Engineering, 35(12).
- Webster CE, Clasper J, Gibb I, Masouros SD (2019). *Environment at the time of injury determines injury patterns in pelvic blast*. Journal of the Royal Army Medical Corps, 165(1): 15-17.
- Zaharie DT, Phillips ATM (2019). *A comparative study of continuum and structural modelling approaches to simulate bone adaptation in the pelvic construct*. Applied Sciences, 9(16).

As well as the list of publications above, there are many other publications which are produced by Centre members. The above list has been kept to only those which are of direct relevance and funded by the Centre for Blast Injury Studies.

## Invited Talks

- Azor A: *A new pipeline for subject-specific diffusion segmentation (SSDS)*. Brain Meeting, London, UK, May 2019
- Azor A: *Developing an MRI diagnostic for blast-induced traumatic brain injury*. Blast Injury Conference 2019, London, UK, July 2019.
- Bull AMJ: *Plenary Keynote Engineering mitigation, protection, and rehabilitation due to high energy trauma, focusing on amputees*. 7th Dutch Bio-Medical Engineering Conference, Egmond aan Zee, the Netherlands, 2019.
- Campos-Pires R: *Xenon Treatment Prevents Late Onset Cognitive Impairment and Improves Survival Following Traumatic Brain Injury in Mice*. The 13th World Conference on Brain injury, Toronto, Canada, March 2019.
- Dickinson R: *Xenon improves long-term cognitive function, reduces chronic neurodegeneration and neuroinflammation, and improves survival after traumatic brain injury*. Blast Injury Conference 2019, London, UK, July 2019.
- Dickinson R: *Xenon neuroprotection in translational preclinical models of traumatic brain injury*. Frontiers in Translational Neuroscience (FTN) Seminar program of Universitätsmedizin der Johannes Gutenberg-Universität Mainz, Germany, September 2019.
- Donat CK: *Computational strain prediction through Finite element modelling predicts the pathophysiological patterns of impact-related experimental Traumatic Brain Injury*. Blast Injury Conference 2019, London, UK, July 2019.
- Donat CK: *Finite element modelling of brain biomechanics predicts white matter pathophysiology following experimental Traumatic Brain Injury*. Brain meeting, London, UK, May 2019.



Foss LJ: *The Royal British Legion Centre for Blast Injury Studies at Imperial College London*. 22<sup>nd</sup> United Nations Mine Action Service National Director's Meeting, Geneva, February 2019.

Ghajari M: *Invited academic visit, Army Medical University (Third Military Medical University)*. Chongqing, China, June 2019.

Ghajari M: *Invited academic visit, Northwestern Polytechnical University*. Xi'an, China, June 2019.

Gibb I: *Forensic radiology use in investigation of Manchester and Tunisia Attacks*. NATO Medical Lessons Conference, Lichfield, UK, May 2019.

Gibb I: *Post mortem imaging in the Military*. Society of Radiologists in Training, Cardiff, UK, May 2019.

Higgins C: *Hacking the skins ability to bear load*. Manchester Regenerative Medicine Network meeting, Manchester, UK, November 2019.

Le Feuvre P and Mayhew E: *Rehabilitation of the combat casualty*. Moodys Investment Ratings Agency, London, UK, April 2019.

Mayhew E: *Unexpected Survivors and the Guinea Pig Club: Lessons for cohort studies today*. Arthur Thompson Annual Lecture, University of Birmingham, UK.

Mayhew E: 16<sup>th</sup> May Royal Shakespeare Company Writer's Event (writing about pain and injury).

Mayhew E: Opening speaker at Invictus Games selection event conference, Sheffield, July 2019.

Mayhew E: Hackathon, Prolonged Field Care, West Point Academy, USA, August 2019.

Mayhew E: Keynote speaker at the Military Health System Research Symposium (MHSRS), Florida, USA, August 2019.

Mayhew E: *A History of Role 2*. 2 Medical Brigade strategy meeting, Strensall, Yorkshire, September 2019.

Mayhew E: *A History of Trauma*. Royal Society of Medicine, London, UK, October 2019.

Mayhew E: *A Heavy Reckoning*. Wessex Anaesthetists In Training Annual Conference, Hampshire, UK, October 2019.

Mayhew E: Filmed segment: Annual Help for Heroes Conference, November 2019

Mayhew E: Keynote speaker at the Tri-Service Emergency Medicine Annual Meeting, October 2019.

Mayhew E: Chair of Science and War Segment, World Extreme Medicine Conference, Edinburgh, UK, November 2019.

Reichenbach T: *Decoding the neural processing of speech*. Engineering Seminar, Ruhr-University Bochum, Germany, November 2019.

Reichenbach T: *Decoding attention to speech*. International Congress on Acoustics, Aachen, Germany, September 2019.

Reichenbach T: *Decoding the neural processing of speech*. Neuroscience Seminar, Maastricht University, The Netherlands, September 2019.

Reichenbach T: *Auditory brainstem response to continuous speech*. University College London, UK, June 2019.

Reichenbach T: *Auditory processing: neuroengineering and diagnostics of cognition*. TU Munich Neuroengineering Retreat, Brixlegg, Austria, June 2019.

Reichenbach T: *Nonlinear micromechanics of the organ of Corti in the low-frequency region of the cochlea*. Symposium, 9th FAOPS Congress, Kobe, Japan, March 2019.

Reichenbach T: *Towards a smart hearing aid*. Bioengineering Seminar, Nottingham Trent University, UK, February 2019.

Reichenbach T: *Towards a smart hearing aid*. Seminar, Wright-Patterson Airforce Base, Dayton, USA, February 2019.

## Conference Presentations and Involvement in Subject Specific Meetings

[Speech-in-Noise Workshop, Leuven, Belgium, January 2019.](#)

Saiz-Alia M, Reichenbach T, *Hidden hearing loss and selective attention in the brainstem (poster)*.

[Imperial Stem Cell and Regenerative Medicine Network Symposium, London, UK, February 2019.](#)

Sory D, *Boosting engineered-bone and -cartilage tissue using high strain rates*.

[Midwinter Meeting of the Association of Otolaryngology \(ARO\), Baltimore, USA, February 2019.](#)

Saiz-Alia M, Forte AE, Reichenbach T, *Hidden hearing loss and selective attention in the brainstem (poster)*.

[Orthopaedic Research Society Annual Meeting 2019, Texas, USA, February 2019.](#)

Rankin S, Sory D, Amin HD, Chapman DH, Proud WG, *Novel platforms to investigate blast-induced Heterotopic Ossification at a cellular level (poster)*.

[13<sup>th</sup> World Conference on Brain Injury, Toronto, Canada, March 2019.](#)

Campos-Pires R, Hirnet T, Valeo F, Ong BE, Saville J, Radyushkin K, Edge C, Franks N, Thal S, Dickinson R, *Xenon treatment prevents late onset cognitive impairment and improves survival following traumatic brain injury in mice*.

Campos-Pires R, Mohamed-Ali N, Balaet M, Aldhoun J, Abelleira-Hervas L, Aitken P, Edge C, Franks N, Dickinson R, *Xenon treatment reduces secondary injury development and prevents neuronal loss and microglial proliferation in a rat model of traumatic brain injury*.

Campos-Pires R, Yonis A, Pau A, Macdonald W, Harris K, Edge C, Franks N, Dickinson R, *The noble gas xenon prevents injury development following blast-traumatic brain injury in vitro*.

[Combined Services Orthopaedic Society \(CSOS\) Conference, London, UK, May 2019.](#)

McMenemy L, Mondini V, Roberts D, Kedgley A, Clasper J, Stapley S, *Pattern of upper limb amputation associated with lower limb amputation: the UK experience from Iraq and Afghanistan*.

*This presentation was awarded the Best Clinical Paper at the CSOS meeting.*

Rankin I, Nguyen T, Carpanen D, McMenemy L, Clasper JC, Masouros SD, *Restricting lower limb flail is key to preventing fatal pelvic blast injury*.

[Organization for Human Brain Mapping Annual Meeting, Rome, Italy, June 2019](#)

Azor A, Sharp D, Hellyer P, *Measuring diffusivity at the edges of the white matter*.

[Recovery Re-defined MDT Conference, London, UK, June 2019.](#)

Le Feuvre P, *MDT vs IDT Management of the complex case*.

[37<sup>th</sup> Annual National Neurotrauma Symposium, Pittsburgh, USA, June 2019.](#)

Campos-Pires R, Mohamed-Ali N, Balaet M, Aldhoun J, Abelleira-Hervas L, Aitken P, Edge CJ, Franks NP, Dickinson R, *Xenon reduces secondary injury, prevents neuronal loss and neuroinflammation in a rat model of traumatic brain injury*.

Campos-Pires R, Hirnet T, Valeo F, Ong BE, Radyushkin K, Aldhoun J, Saville J, Edge CJ, Franks NP, Thal SC, Dickinson R, *Xenon prevents neurodegeneration and late-onset cognitive impairment and improves survival after traumatic brain injury in mice*.

Campos-Pires R, Yonis A, Pau A, Macdonald W, Harris K, Franks N, Edge C, Dickinson R, 2019, *Delayed xenon treatment prevents injury development following blast-neurotrauma in vitro*.

[Blast Injury Conference 2019, London, UK, July 2019.](#)

Azor A et al., *Developing an MRI diagnostic for blast-induced traumatic brain injury*.

Bruyns-Haylett M, Dickinson R, Kozlov A, Bruyns-Haylett M, Dickinson R, Kozlov A, *An investigation of simulated open field blast-induced damage of the auditory cortex at the level of cells and neural circuits using an in vivo rat model*.

Edwards K, et al., *Validation of an FE model for establishing characteristics of a Passive Dynamic Ankle-Foot Orthosis.*

Le Feuvre P, *Understanding the process of recovery for a military amputee.*

McMenemy L, Mondini V, Roberts D, Kedgley A, Clasper J, Stapley S, *Pattern of upper limb amputation associated with lower limb amputation: the UK experience from Iraq and Afghanistan.*

Meek G, et al., *Soft armour for protection against penetrative injury to the extremities.*

Rankin I, et al., *Restricting lower limb flail is key to preventing fatal pelvic blast injury.*

Rankin S, *Traumatic mechanobiology: Dissecting the mechanical loading conditions that lead to molecular responses in mesenchymal stromal cells.*

Rebello E, et al, *Development of under-body blast mitigation systems using finite element of the foot and ankle .*

Yu X et al., *Kinematics and Pressure Wave Transmission on Blast Induced Traumatic Brain Injury.*

[Rehab and Recovery Symposium, Sheffield, UK, July 2019.](#)

Le Feuvre P, *Management of the complex case: An Interdisciplinary approach vs multidisciplinary working.*

[25<sup>th</sup> Congress of the European Society of Biomechanics, Vienna, Austria, July 2019.](#)

Edwards KG, Grigoriadis G, Carpanen D, Masouros S, *Characterisation of a passive dynamic ankle-foot orthosis using a finite element model.*

Ramette M, Bull AMJ, *The 'saturation' of load-driven bone remodelling: Application to Heterotopic Ossification.*

Rebello E, Grigoriadis G, Carpanen D, Bull AMJ, Masouros S, *The development of blast protection means using a finite element model of the foot and ankle.*

Shanel S, McGregor A, Bull AMJ, *Males and Females exhibit similar gait changes when carrying military loads.*

[2<sup>nd</sup> Mechanobiology Meeting: When Physics meets Biology, Quy Nhon, Vietnam, July 2019.](#)

Sory D, *Novel Platforms to Investigate Blast-Induced Heterotopic Ossification at a Cellular Level.*

[17<sup>th</sup> International Symposium on Computer Simulation in Biomechanics, Canmore, Canada, July 2019.](#)

Kaufmann J, Phillips ATM, McGregor AH, *Bone health in transfemoral amputees.*

Phillips ATM, *Structural modelling of trabecular bone using a Voronoi network.*

[Military Health System Research Symposium, Florida, USA, August 2019.](#)

Rankin I, et al., *Restricting lower limb flail is key to preventing fatal pelvic blast injury (poster).*

Rankin I, et al., *Reinforced pelvic protection mitigates the effects of dismounted pelvic blast injury (poster).*

[27<sup>th</sup> Congress of the International Society of Biomechanics, Calgary, Canada, August 2019.](#)

Kaufmann J, Phillips ATM, McGregor AH, *Bone health in transfemoral amputees.*

Phillips ATM, *Structural modelling of trabecular bone using a Voronoi network.*

[Auditory EEG Signal Processing Symposium, Leuven, Belgium, September 2019.](#)

Etard O, *Neural speech tracking in the delta and theta frequency bands differentially encodes comprehension and intelligibility of speech in noise.*

[BioMedEng 2019, London, UK, September 2019.](#)

Nguyen T, et al., *The Fracture Risk of Fragment Penetrating Injury to the Tibia.*

[British Orthopaedic Association Conference, Liverpool, UK, September 2019.](#)

McMenemy L, Mondini V, Roberts D, Kedgley A, Clasper J, Stapley S, *Pattern of upper limb amputation associated with lower limb amputation: the UK experience from Iraq and Afghanistan.*

International Congress on Acoustics, Aachen, Germany, September 2019.

Saiz-Alia M, Forte AE, Reichenbach T, *Selective attention in the brainstem and speech-in-noise comprehension.*

International Research Council on Biomechanics of Injury (IRCOBI) 2019, Florence, Italy, September 2019.

Nguyen T, Masouros S, *Penetration of blast fragments to the thorax.*

International Society of Prosthetics and Orthotics, Kobe, Japan, October 2019.

McMenemy L, Mondini V, Roberts D, Kedgley A, Clasper J, Stapley S, *Pattern of upper limb amputation associated with lower limb amputation: the UK experience from Iraq and Afghanistan.*

Turner S, *Assessing the impact of prosthetic socket fit on major lower limb amputee rehabilitation.*

Light-weight Armour for Defense and Security (LWAG) 2019, France, October 2019.

Nguyen T, Meek G, Masouros S, *Blast fragment protection for the extremities.*

Major Trauma Update, Royal Society of Medicine, London, UK, October 2019.

Le Feuvre P, *Defining a Rehabilitation Pathway for Military Lower Limb Amputees.*

Society for Neuroscience Annual Meeting, Chicago, USA, October 2019.

Azor A, Sharp S, Hellyer P, *Measuring diffusivity at the edges of the white matter.*

Donat CK, Ghajari M, Yanez Lopez M, Goldfinger M, Baxan N, Gentleman S, Sastre M, Sharp DJ, *Finite element modelling strain prediction of a rat Controlled Cortical Impact injury correlates with DTI and histology measures of pathophysiology.*

NATO ARRCADe meeting, Newquay, UK, November 2019.

Mayhew E, *Military medical/humanitarian communications.*

## Grants

Centre members received a number of grants in 2019 which relate to research funded by the Centre. The table below provides an overview.

Funder	Amount	Title	Lead applicant
Guarantors of Brain	£1,000	Travel grant	Adriana Azor
AR-UK ICL Network	£4,000	Equipment grant	Dr Cornelius Donat
Imperial College-TUM	£6,530	Nonlinear topology optimisation of lattices	Dr Mazdak Ghajari
Royal Society	£17,231	High fidelity surrogate necks for TBI research	Dr Mazdak Ghajari
DSTL	£60,882	Predicting penetration through skeletal tissue	Dr Spyros Masouros
Association of Paediatric Anaesthetists of Great Britain & Ireland	£39,925	The effect of xenon-treatment on the developing brain following paediatric neurotrauma	Dr Robert Dickinson and Dr Rita Campos-Pires
Army Research Office, Life Sciences Division	£250,000	Computational model for understanding and predicting the effects of transcranial current stimulation on audiovisual speech recognition	Dr Tobias Reichenbach
Wolfson Foundation	£1,000,000	Core Facility Suite	Professor Anthony Bull
EPSRC	£1,281,963	Injury & reconstruction biomechanics test suite	Dr Spyros Masouros
ESPRC	~£1,700,00 to Imperial (total grant £5.5m)	Centre for Doctoral Training in Prosthetics and Orthotics. Led by the University of Salford, in collaboration with the University of Strathclyde, the University of Southampton and Imperial College London	Professor Anthony Bull is the lead Co-Investigator at Imperial College London.

## Education

Centre members are involved in education through a range of activities at Imperial College London. This varies from teaching on courses for undergraduates and postgraduates to supervising students during projects of varying durations. Below are some examples of the activities that members have been involved in this year.

### Undergraduate Projects

A number of undergraduates have undertaken research with Centre members as part of the Undergraduate Research Opportunities Programme (UROP) this year. Below is an overview of some of the projects:

- Project 1: David Henson supervised a UROP student, C. Edgar, who was investigating muscle hypertrophy and atrophy in amputees of different amputation classification. This work is incredibly useful in understanding and evidencing amputee muscle recruitment and movement compensation strategies, as well as providing much needed information on the composition and physiology of amputee muscle for use in computational simulations of amputee movement. This work is currently being prepared for publication.
- Projects 2 and 3: S. Jain and A. Patel – ‘Clinical application of pressure sensors in prosthetic sockets’ – supervised by Shruti Turner and Professor Alison McGregor. The students worked on a program to optimise a 3D model which shows the pressure distribution in the prosthetic socket using data from sensor hardware being developed by the team. They also looked at the feasibility of using conductive fabric and sensors to integrate the sensors into a prosthetic liner.
- Project 4: P. Miller – ‘Selective attention in the inner ear’ – supervised by Dr Tobias Reichenbach. The project assessed effects of selective attention to one of two speakers through measurements from the inner ear. It did so by developing a method to evoke otoacoustic emissions related to speech.
- Project 5: A. Schmitt (Université de Lorraine) – ‘The mechanical response of the temporo-mandibular joint at high strain rates’ – supervised by Dr Bill Proud and Dr David Sory. The project investigated the mechanical response of the temporo-mandibular joint at high strain rates. The samples were obtained from pig heads and the team used a split-Hopkinson pressure bar to expose the samples to strain rates from 1,000 /s to 3,500 /s. Viscoelastic models were fitted on the experimental data.
- Project 6: K. Wendt – ‘Neural responses to word features’ – supervised by Dr Tobias Reichenbach. The project developed computational methods to assess speech comprehension from EEG responses. It achieved this by assessing neural responses to word features in spoken language.

### Masters Projects

Centre members have been involved in the supervision of multiple Masters projects throughout 2019. Below are some examples of these projects:

- Project 7: T. Ahmed – ‘Selectivity properties of central auditory neurons’ – co-supervised by Dr Michael Bruyns-Haylett and Dr Andrei Kozlov. This project investigated whether blast injury affected the relationship between neural population recordings (local field potentials: LFPs) and a range of complex ‘cocktail party’ stimuli of natural vocalisation recordings in an anaesthetised rat model. Stimuli envelopes were obtained using the Hilbert transform, and these were compared with LFP responses filtered into different EEG frequency bands using cross correlation analysis. Findings agree with previous studies showing that responses filtered into different EEG bandwidths and natural speech vocalisation envelopes (NSEs) have a distinct relationship. More data collection is required.



- Project 8: M. Batliner – ‘Xenon combined with hypothermia protects against neuronal loss in the hippocampus after experimental blunt-TBI’ – co-supervised by Dr Robert Dickinson and Dr Rita Campos Pires.
- Project 9: T. Gonzales – ‘Comparison of the mechanosensitivity in human-BMSCs and rat BMSCs and PO-MSCs’ – co-supervised by Professor Sara Rankin and Dr David Sory. The project compared the mechanosensitivity of stem cells from different tissues (bone marrow and periosteum) and different species (rat and human) under mechanical loading mimicking landmine blast loading.
- Project 10: N. Kano – ‘Neuroprotection by xenon combined with hypothermia in rat cortex following experimentally induced traumatic brain injury’ – co-supervised by Dr Robert Dickinson and Dr Rita Campos Pires.
- Project 11: I. Ong – ‘Characterization of neuronal loss in blast traumatic brain injury using a shock tube model’ – co-supervised by Dr Warren Macdonald and Dr Rita Campos Pires.
- Project 12: H. Ongraditto – ‘Investigating the neuroprotective effects of xenon on neuronal loss in controlled cortical impact model of traumatic brain injury’ – co-supervised by Dr Robert Dickinson and Dr Rita Campos Pires.
- Project 12: M. Radaelli – ‘The biomolecular response of human bone marrow stem cells to high pressure applied at high strain rate’ – co-supervised by Dr David Sory and Professor Sara Rankin. The project investigated the metabolic response of human stem cells to mechanical loading mimicking landmine blast trauma of lower limb.
- Project 14: D. Savani – ‘Traumatic brain injury-induced neuroinflammation and its effects on neurodegeneration’ – co-supervised by Dr Magdalena Sastre and Dr Cornelius Donat. The project investigated the neuroinflammatory response and its effect on proteins involved in Alzheimer’s disease and neuronal loss 3 and 15 days after a moderate controlled cortical impact injury. Expression of enzymes involved in amyloid  $\beta$  generation increased transiently in proximity to the impact and in the hippocampus, levels of hyperphosphorylated tau were increased in regions showing a neuroinflammatory response. The findings indicate a role of the inflammatory response in neurodegeneration and hallmark proteins of Alzheimer’s disease.
- Project 15: B. Shadbolt – ‘Neuronal cell viability following mild and severe blast traumatic brain injury’ – co-supervised by Dr Robert Dickinson and Dr Rita Campos Pires.
- Project 16: T. Velez Perez – ‘The effect of repetitive mild blast traumatic brain injury and xenon treatment on neuronal cell density in cortical and limbic areas in the rat brain’ – co-supervised by Dr Robert Dickinson and Dr Rita Campos Pires.
- Project 17: G. Meek – ‘Blast fragment protection for the extremities’ – co-supervised by Dr Thuy-Tien Nguyen and Dr Spyros Masouros.
- Project 18: N. Barnett-Johnston – ‘Modelling dismantled pelvic injury’ – co-supervised by Dr Dilen Carpanen and Dr Spyros Masouros.



**Imperial College**  
London



THE ROYAL BRITISH LEGION

**CENTRE FOR BLAST INJURY STUDIES**

AT IMPERIAL COLLEGE LONDON

