



2012

## CBIS current work

*Annals of Biomedical Engineering* (© 2013)  
DOI: 10.1007/s10439-013-0814-6



### Design of a Traumatic Injury Simulator for Assessing Lower Limb Response to High Loading Rates

SPYROS D. MASOUIROS,<sup>1</sup> NICOLAS NEWELL,<sup>1</sup> ARUL RAMASAMY,<sup>1,2</sup> TIMOTHY J. BONNER,<sup>1,2</sup>  
ANDREW T. H. WEST,<sup>3</sup> ADAM M. HILL,<sup>1,2</sup> JON C. CLASPER,<sup>1,2</sup> and ANTHONY M. J. BULL<sup>1</sup>

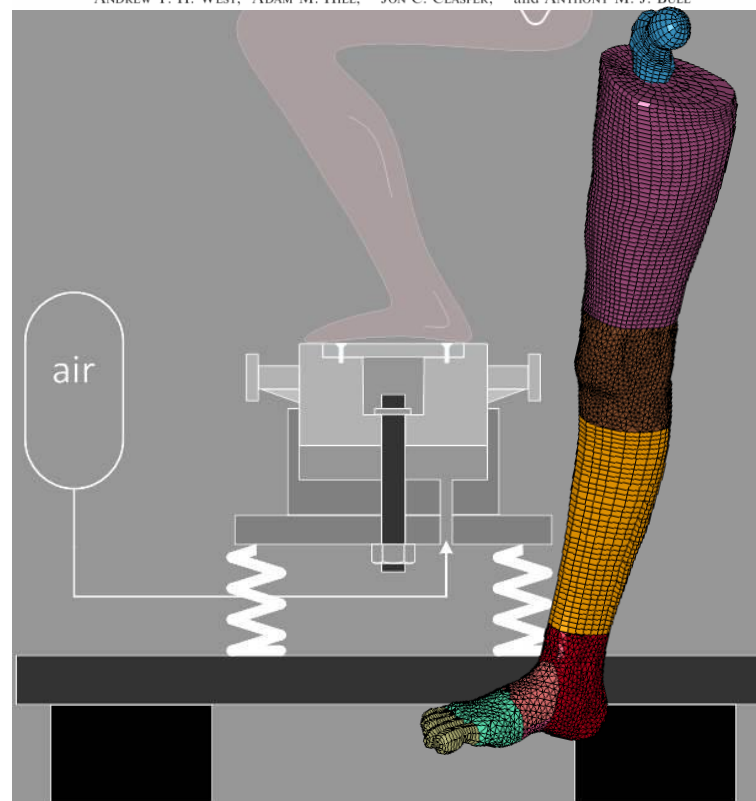

The Royal British Legion

Centre for Blast Injury Studies

at Imperial College London

July 2013

# Centre for Blast Injury Studies current work

---

**The Royal British Legion Centre for Blast Injury Studies at Imperial College London**

**<http://www.imperial.ac.uk/blastinjurystudies>**

**London, July 2013**

# Contents

Introduction.....	3
Governance and Finance .....	4
The Problem .....	6
Areas of Research.....	9
Themes and Priorities.....	9
Blast Biomechanics.....	10
Blast Biology and Therapeutics .....	11
Blast Force Protection .....	11
Clinical .....	12
Introduction.....	12
Patients and Methods .....	12
Results .....	12
Conclusion and Future Work.....	14
Development of Technologies to Study Blast Injury .....	15
Traumatic Injury Simulator (AnUBIS) .....	15
The Shock Tube .....	16
In Vivo Models.....	18
Computational Modelling.....	19
Biological Tissue.....	20
Nervous System Cellular Response to Stress Waves.....	20
Nerve Injury.....	24
Response of Mesenchymal Stem Cells (MSCs) to Stress Waves .....	25
Response of Neutrophils to Stress Waves.....	27
Tissue Models of Blast Injury.....	29
The Lower Extremity .....	31
Protective Systems .....	33
Assessment of Surrogates for Protection of the Lower Extremity.....	33
Convoy Matting for Protection of the Lower Extremity.....	35
Combat Boot Behaviour - Towards Optimisation .....	37
Ear Protection - Interaction Between Blast Waves and Reticular Foam.....	38
External Collaboration .....	39
CBIS at Imperial College London .....	39
The Royal Centre for Defence Medicine .....	40
Defence Science and Technology Laboratory .....	40
University of Cambridge Collaboration .....	40
Communication of the Work .....	41
Media Focus .....	41
Invited Lectures.....	41
Awards.....	42
Recent Publications .....	42
Education.....	45

## Foreword

This Annual Report represents the first for the Royal British Legion Centre for Blast Injury Studies at Imperial College London (CBIS) having evolved from Imperial Blast established in 2008. The pace of change has been considerable with the support provided by the Royal British Legion enabling the Centre to grow in its capacity for research and effect.

An annual networking event and membership of NATO's Human Factors and Medicine Task Group have thrust CBIS to the epicentre of Blast Injury Studies research on a national and international stage with the resultant new collaborations extending the reach into areas such as neuroscience and rehabilitation.

Core to our work has been the research conducted by the Centre; details are included in this report. I have been extremely pleased with the growth in external recognition of our work with awards won for both publications and presentations in the UK and also the US. This has reinforced the Centre's academic credibility and laid a solid bedrock for future studies whilst we explore related areas. This also accentuates the expertise and diligence of all those involved in the Centre's activities.

Surrounding this has been the formalising of the management structure, strategy and governance. The CBIS Advisory Board is a noteworthy addition to the Centre. Chaired by Admiral the Lord Boyce KG GCB OBE DL a former Chief of Defence Staff, the Board consists of eminent figures from Industry, Health, Academia and the Military. This added layer of oversight and advice has proved invaluable during this stage in our development and we are exceptionally fortunate to benefit from their input.

This has been an exciting period of evolution with much more to follow. We eagerly look forward to the challenges and opportunities that the next phase of growth will undoubtedly bring whilst remaining true to our central objective of increasing lifelong health and quality of life to those affected by blast injury.

**Professor Anthony M J Bull**

**Director, The Royal British Legion Centre for Blast Injury Studies at Imperial College London**

## Introduction

The conflicts in Iraq and Afghanistan have been epitomised by the insurgents' use of the improvised explosive device and anti-vehicle mines against security forces in vehicles and on foot. These weapons, capable of causing multiple severely injured casualties in a single incident, pose a significant threat to Coalition troops operating in the region. Improvements in personal protection and medical care have resulted in increasing numbers of casualties surviving with complex lower limb injuries, often leading to long-term disability.

The Centre for Blast Injury Studies is established to address the disabling injuries of current and previous conflicts. The Centre consists of leading researchers across all relevant disciplines and across academia and the Ministry of Defence. This multi-disciplinary effort ensures that the right questions are asked, the difficult answers addressed, and the most appropriate technologies innovated. The focus of the Centre is to deliver tangible results in the shortest time possible whilst also fulfilling the mission statement of the university, which is:

*Imperial College embodies and delivers  
world-class scholarship, education and research  
in science, engineering and medicine,  
with particular regard to their application  
in Industry, Commerce and Healthcare.  
We will foster interdisciplinary working within the College  
and collaborate widely externally.*

Our approach to improving mitigation of, and recovery from, these injuries is clinically-led through data acquisition and analysis from all appropriate battlefields. We then develop the science and engineering research and application across all relevant disciplines. This report summarises the Centre's current work, describes our future direction, and as befits its status as the first report of the fully-fledged Centre for Blast Injury Studies, describes our structure, governance and finances in some detail.

## Governance and Finance

The Centre is located in the South Kensington Campus of Imperial College London with its central facilities hosted by the Department of Bioengineering. This is complemented by satellite locations within other related departments. In addition, the Centre has staff embedded in the Cavendish Laboratory in Cambridge University and associated programmes in St Georges Hospital, London.

The Centre comprises over 30 core and associated staff having concentrated on recruiting key positions within the past year. The increase in personnel has been met with equal development in facilities with offices and bespoke laboratories created in tandem. Further expansion will continue throughout 2013/14. The Centre is arranged in accordance with our organisational chart (Figure 1).

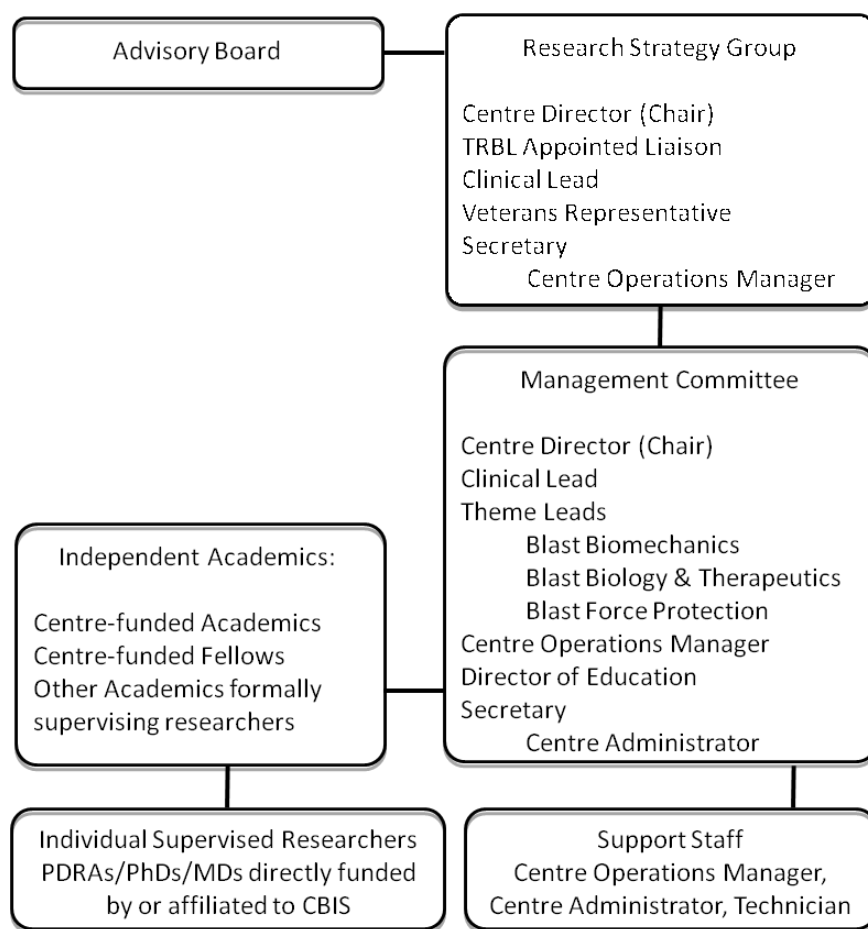

**Figure 1: Centre organisation**

### Advisory Board

CBIS is afforded external advice and guidance through its Advisory Board. Currently chaired by a former Chief of Defence Staff (CDS) the board comprises prominent figures from the arenas of Health, Industry and Defence. Strategic guidance and an ambassadorial function are but two of the roles of this executive oversight committee.

## Research Strategy Group

The Research Strategy Group is the primary mode of exchange between the Centre, including the Clinical Lead and its sponsor. A quarterly update is provided focussing on each area of Centre research and their related outputs with specific reference to technology transfer.

## Centre Management Committee

The Centre Management Committee comprises the research Theme Leads, Clinical Lead, Educational Lead and the Operations Manager. The monthly Committee meeting conducts the internal management of the Centre ensuring the financial governance and integration research.

## Vision

CBIS seeks to further understanding in the area of blast injury through a collaboration of engineers, scientists, and clinicians to change the paradigm by which blast on the human body is mitigated, injuries managed acutely, and reconstruction, regeneration and rehabilitation enhanced in order to improve clinical treatment and influence strategies such as equipment design.

## Mission

This vision is consolidated within the Centre's Mission Statement:

---

*To improve the mitigation of injury,  
develop and advance treatment,  
rehabilitation and recovery  
in order to increase lifelong health  
and quality of life after blast injury.*

---

## Finance

The Centre is funded through generous financing from The Royal British Legion and commensurate commitments from both Imperial College and the MOD. The funding provides a clear research programme through to November 2016 with options to extend. Figure 2 depicts a breakdown of the Centre's TRBL grant allocation.

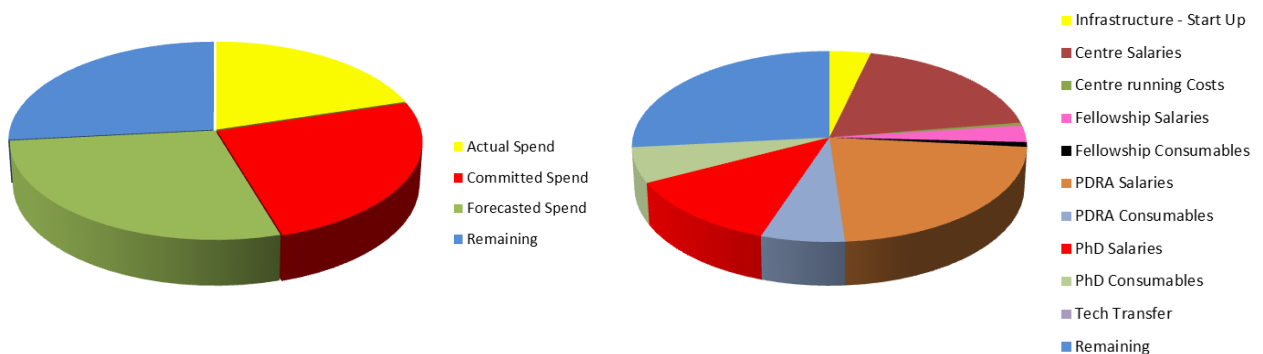

**Figure 2: Centre grant allocation breakdown**

## The Problem

The increased use of buried improvised explosive devices (IEDs) in modern combat has resulted in a change to the pattern of injuries seen in casualties, both for mounted (in-vehicle) and dismounted (on foot) personnel. Much practical experience was gained in the area of blunt trauma in the naval and other theatres in the Second World War and onwards. IEDs are responsible for the majority of combat injuries and exhibit characteristic injury patterns that include trauma to lower limbs, lungs and the brain. Fewer fragment-impact injuries are observed because the act of burying the IED provides a limited amount of mitigation. Primary blast can result in extensive soft tissue damage, some of which occur immediately and some on a delayed timescale. An example is “blast lung”, the symptoms of which may appear days after the initial blast exposure making diagnosis particularly challenging. In addition, post-traumatic complications at wound sites can include heterotopic ossification (the formation of non-functional bone within muscle) and infections acquired at the time of injury and/or in hospital settings where the injuries are treated. The three main types of blast injury mechanism are shown in Figure 3.

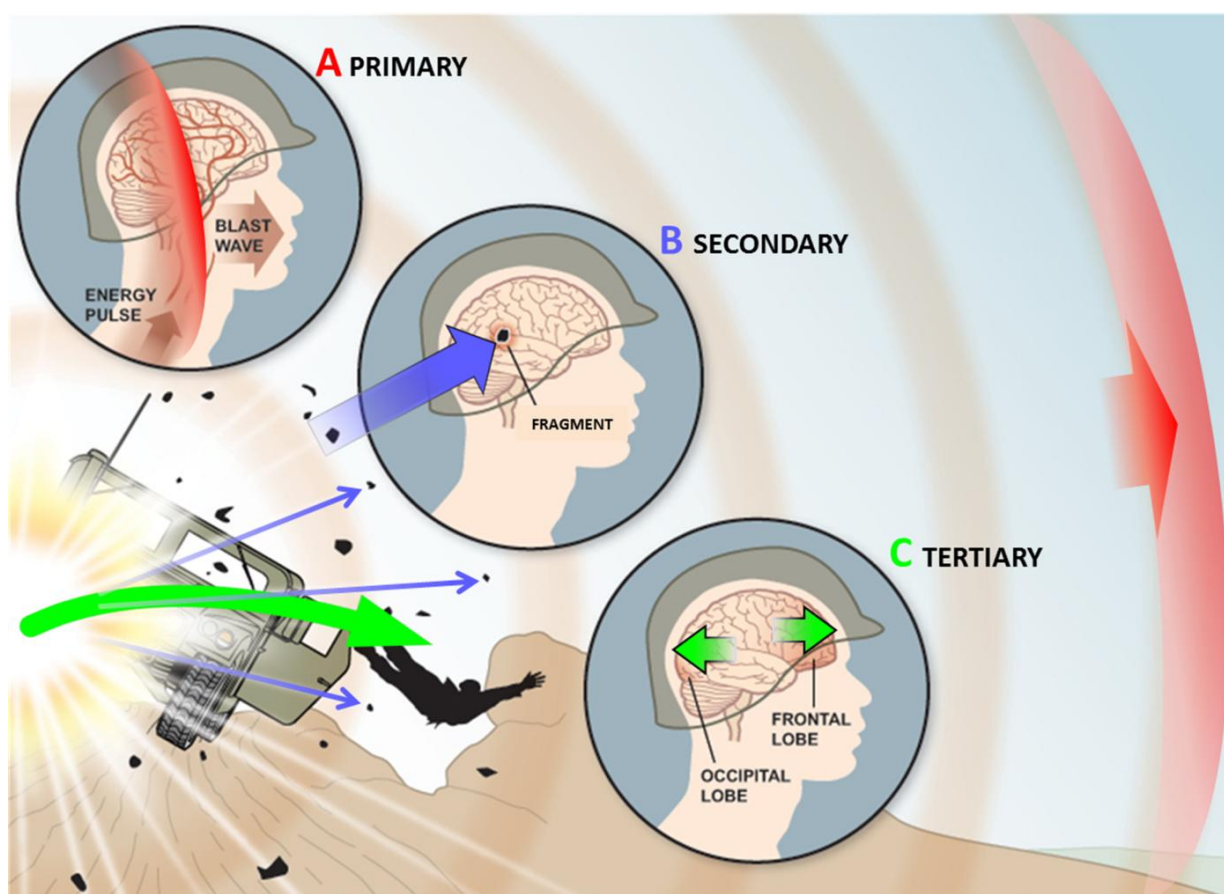

Figure 3: Blast injury mechanisms

**A – Shockwave causing primary blast injury.**

**B – Fragments thrown out by the explosion causing (mainly) penetrating secondary blast injury.**

**C – Whole body displacement from the blast wind causing blunt trauma tertiary blast injury.**

The multiple mechanisms of quaternary blast injury are not shown here.

Image modified from Al Granberg graphic ([www.propublica.org/special/tbi-in-combat](http://www.propublica.org/special/tbi-in-combat)).



The difference in injury patterns between mounted and dismounted personnel has both obvious and subtler aspects. Dismounted personnel experience a higher incidence of traumatic amputation and fragment injuries with less evidence of blast lung compared to mounted personnel who have less fragment injury. A blast that is partially confined between the ground and a vehicle results in a large transfer of momentum. This effect causes an increase in tertiary blast injuries, which are defined as injuries caused by the acceleration of the entire body against mobile or fixed objects. A more subtle effect is that a blast wave transmitted through the floor into the vehicle, whilst having a reduced peak pressure compared to a blast external to the vehicle, is reflected from the many internal vehicle surfaces resulting in a longer, more complex blast loading on the occupants.

The fundamental cause of the primary or blast injury is the expansion of product gases from explosives that produces the blast wave. The classic representation of a blast wave is shown in Figure 4; the Friedlander waveform. This type of pressure profile is seen in situations where the blast wave can expand freely and is not reflected from hard surfaces. After the initial rapid rise of the blast wave there is a region of positive pressure, accelerating outwards from the explosion. The speed of the gas moving behind the blast front, in the so-called 'blast wind', can be as high as 2000 km/hr. This is followed by a release wave that drops the pressure below atmospheric pressure. The release occurs as both air and product gases have expanded outwards, away from the place where the explosion initiated. This results in a partial vacuum in the region of initial explosion and this lower pressure now causes air and gases to flow backwards. The push-pull movement, along with the resulting shear, can be especially damaging.

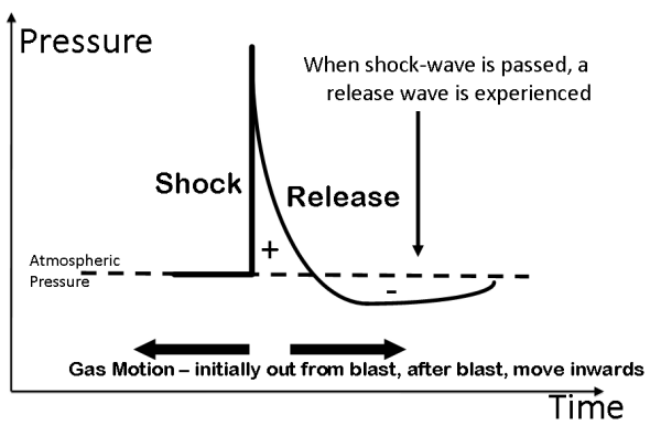

Figure 4: Classic Friedlander form of a blast wave

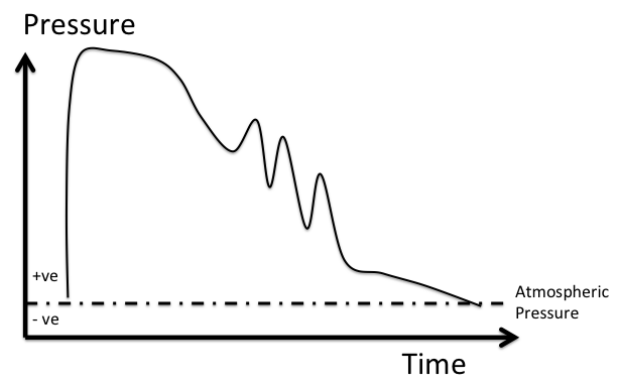

Figure 5: Indicative waveform of loading internal to a vehicle

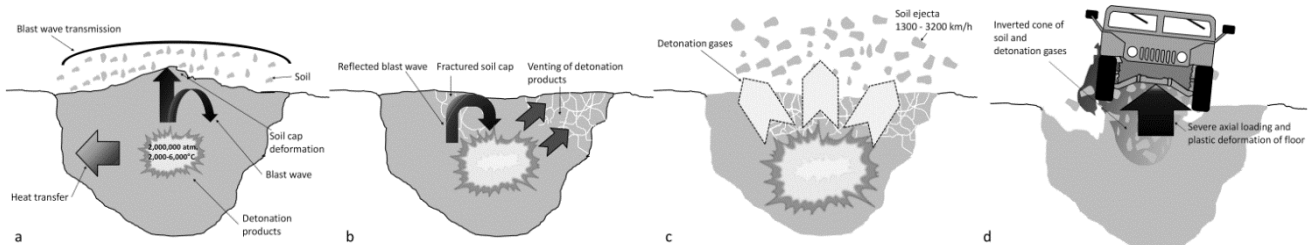

Figure 6: AV mine blast.

- (a) Triggering of the mine results in an exothermic reaction and formation of a blast wave.
- (b) The blast wave is mainly reflected at the soil-interface and causes fracture of the soil cap.
- (c) The detonation products are vented through the fractured soil cap, resulting in the release of the soil ejecta.
- (d) The overall result is an inverted hollow cone of super-heated detonation gases surrounded by the soil ejecta. They both then act on the floor of the vehicle, resulting in injury to the occupants.

Buried charges produce a more complex waveform. During the detonation process the coupling of the shock wave into the surrounding material results in fracture and compaction producing an impermeable zone of material. This material acts as a weak confinement to the detonation products. This zone of compacted material eventually fractures and the product gases expand through the fissures while continuing to accelerate the compacted material. The expansion of the product gases launches a blast wave that reflects from the base of a vehicle and is strengthened in this confined space. Impact of fragments and compacted material on the base of the vehicle adds further peaks to the pressure profile. All these result in rapid bending of the floor, transmitting injurious loads to the occupants (Figure 6). Finally, potential internal reflections within the vehicle act to produce a very complex waveform of the type shown in Figure 5.

One of the most significant deficits of research into improving vehicular protection from explosions has been the dearth of clinical data for in-vehicle blast casualties. Defence research organisations have often resorted to extrapolate injury profiles from automotive industry data. It is apparent that military blast injuries are not similar to those from road-traffic accidents and the treatment regimes are likely to be significantly different to those applied to a civilian scenario. Recent work by the Centre has highlighted the severe disability resulting from lower limb in-vehicle blast. This has led to changes in the UK Armed Forces Compensation Scheme to reflect the previously unknown severity of these injuries and is driving focussed research to decrease their future incidence. The last 12 months has seen clinical work focus on accurately defining the lethal injury profiles of both mounted and dismounted blast casualties – this will enable mitigation and prevention strategies to be optimally targeted.

Blast injuries are characterised by multiple fractures and chronic pain, often leading to amputation. Specific complications that can develop in traumatised limbs in these war wounds include heterotopic ossification (HO; aberrant bone formation outside the skeletal tissue), and prolonged conduction delays in nerves to the extremities (peripheral nervous system). The fundamental physical properties that govern how live cells respond to external mechanical forces (e.g. blast stimuli) clearly underlie how subsequent cellular responses, such as damage and repair mechanisms, respond in both productive and non-productive manners (i.e. fracture healing compared to HO). Understanding the cellular effects high intensity compression waves induce in human tissues is a critical step towards developing improved therapies for patients suffering from blast injuries.

One of the core features of the Centre for Blast Injury Studies is its focus on driving research priorities based upon contemporary battlefield injury data and long-term functional outcomes of military injury. This is facilitated by its strong partnership with the Royal Centre for Defence Medicine, and the integration of military surgeons with operational experience into this uniquely collaborative research group. This ensures that the group's research is entirely focused in understanding the injuries sustained, and protecting against the threats that might injure UK Service Personnel who are currently deployed on military operations.

# Areas of Research

## Themes and Priorities

To achieve the mission the Centre will conduct targeted and exploratory research in collaboration with the main funder, The Royal British Legion. The research will be supported on a hierarchical basis, with investment in platform and application technologies as well as supporting specific applications. This hierarchy reflects the readiness level distinguishing applications that are likely to have impact sooner, and the platform technologies that are likely to result in more significant, longer-term benefits. The research has three main themes: Blast Biomechanics, Blast Biology and Therapeutics, and Blast Force Protection.

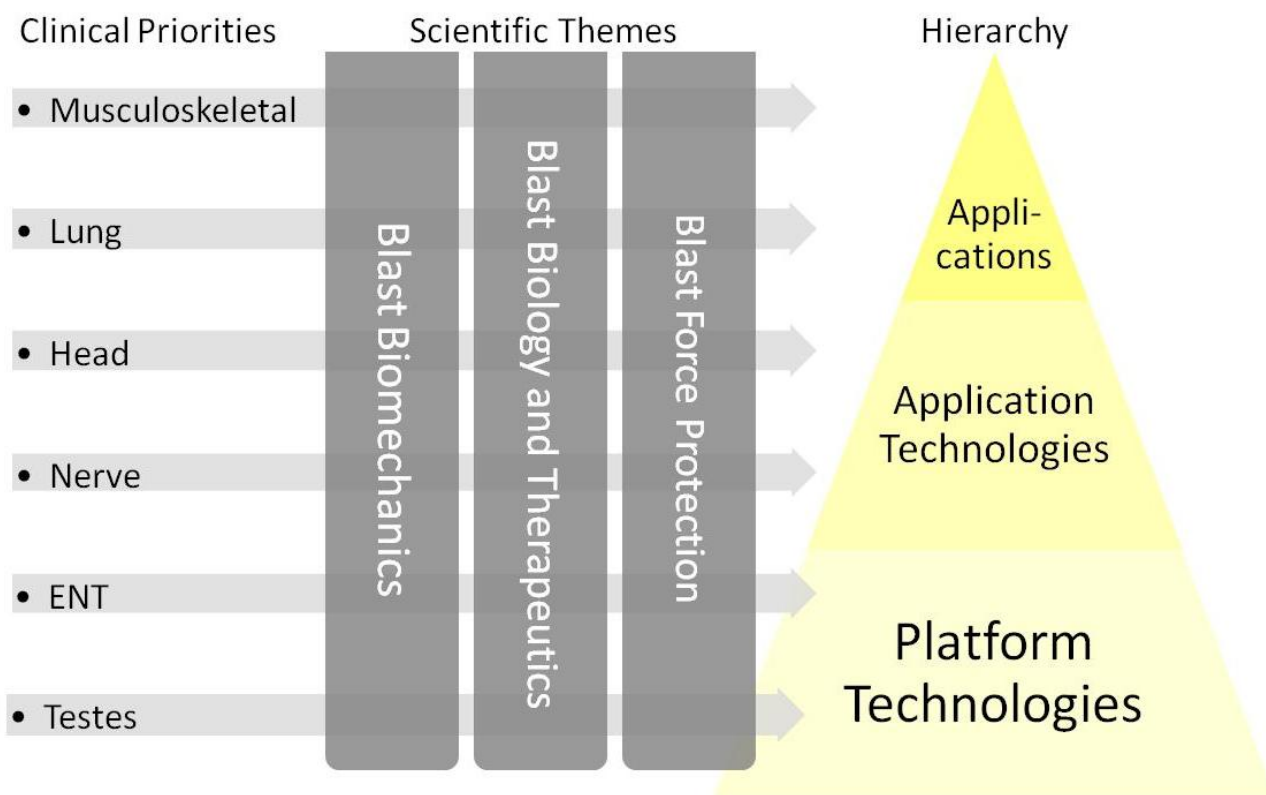

Figure 7: Centre research strategy

All research in the Centre is identified as fitting within at least one of the Themes and linked to one of the platform technologies. Oversight of the research programmes is exercised through the Centre Management Committee with specific responsibility to ensure all research programmes fit within the research priority statement, reproduced below

Research is prioritised based on the following criteria:

- The unique pathologies seen, their disabling nature, including pain, and prevalence.
- Benefit to the armed forces and veterans.
- Research expertise and interest from leading academics involved in CBIS.

### Clinical priorities

- Priority systems: organs, tissues and cells.
- Musculoskeletal (specifically lower limb, pelvis, spine, bone, muscle)
- Lung
- Head – blood/brain barrier
- Nerve
- Testes
- ENT – noise induced hearing loss

### Research approaches

- Structural and physiological effects of blast, lethality, change in function.
- Mechanism of injury due to primary and solid blast
- Therapeutic interventions.
- Mitigation strategies including in-vehicle posture and seating.

Allowing for the above priorities the medium term (>3yrs) focus for the three themes are:

### Blast Biomechanics

- To develop a lower limb FE model that is able to predict the response of the lower limb to high rate impulse loading in order to develop and test mitigation strategies.
- To develop test protocols and equipment able to simulate and quantify the physical response of human tissue and organ specimens under high rate impulse loading in order to develop and test mitigation strategies.
- To develop fast running whole body macro and meso-scale structural fracture models in order to investigate pelvic, spinal, and upper limb injuries to quantify muscle function in fracture mitigation.
- To develop head/neck/brain FE model to quantify the effects of blast on brain in order to develop and test mitigation strategies.
- To develop a fidelic computational model of torso/lungs to predict the response of the lung to blast and impulse loading in order to develop and test mitigation strategies.
- To develop spinal FE model that is able to predict the response of the spine to high rate impulse loading in order to develop and test mitigation strategies.
- To develop fidelic computational models of the biomechanics of hearing and hearing damage in order to develop and test mitigation strategies.

## Blast Biology and Therapeutics

Developing a cellular and molecular understanding of the nature of traumatic and post-traumatic effects of blast events on live biological samples is critical for improving clinical outcomes. A confined Split Hopkinson Pressure Bar (SHPB) system is used in order to investigate the consequences of pressure waves upon cellular structures and the underlying physiological and biochemical changes; this technology allows cells in suspension or in a monolayer to be subjected to high intensity compression waves (HICWs) of the order of few MPa and duration of hundreds of microseconds. Our chamber design also enables recovery of the biological samples for cellular and molecular analysis. Specifically, cell survivability, viability, proliferation and morphological changes are investigated post compression for different cell populations. The cell populations chosen were mesenchymal stem cells, Schwann cells, neurons and neutrophils. The rationale for each choice is outlined in the individual sections below.

Specific objectives for this theme include

- To work in collaboration with the blast force protection group, providing biological samples (cells and tissues) and appropriate analysis to develop experimental platforms to investigate the effects of high intensity compression waves on biological samples.
- To perform the first comprehensive analysis of the effects of high magnitude/dynamic pressure waves on living cells in suspension. The study will compare the molecular and functional effects on blood leukocytes, schwann cells and stem cells.
- To test and compare the effects of high magnitude/dynamic pressure waves on a range of tissues.
- To investigate blast lung at a molecular and cellular level. At a tissue level the effect of loading will be examined on both mouse and human lung tissue and experiments performed in murine models to determine whether products of blast are pro-inflammatory.
- Heterotopic ossification, a unique pathology associated with blast injury will be investigated by conducting experiments to determine whether high intensity compression waves exert an effect on the differentiation pattern of mesenchymal stem cells.

## Blast Force Protection

- Develop well-characterised loading conditions for biological materials, using the knowledge of high-rate diagnostics ensuring these conditions are linked to those seen in the blast environment, particularly the shear and tensile loading as well as the compressive forces. Experimental apparatus must be understood in the variation of stress pulses though a specimen.
- Ensuring that the mounting methods or confinement materials used on biological samples are well understood as biological materials are non-linear in a number of ways including mechanically, therefore, we must understand the effect of the experimental environment on the sample otherwise, conclusions will be difficult to draw.
- Appropriate deployment, calibration and validation of diagnostics over the range of CBIS activities, to ensure the maximum amount of useful data is extracted from each research element.
- Assessment of protective devices and materials including innovative ideas against blast (or impact) damage. Much can be done in the field of 'armour' on vehicles and personnel as much research is performed in industry and government; however, this area will focus on the use of novel materials and ideas in the area of force (or personal) protection, for both civilian and military forces including protection of hearing, vision, heels, knees, torso, etc.

# Clinical

## Introduction

Recent advances in combat casualty care have enabled survival following battlefield injuries that would have been lethal in past conflicts. While some injuries remain beyond our current capability to treat, they have the potential to be future 'unexpected' survivors. A significant threat to deployed coalition troops remains the improvised explosive device (IED) (Figure 9). Therefore, a clear requirement was identified to conduct an analysis of causes of death and injury patterns in recent explosive blast fatalities in order to focus research and mitigation strategies, to further improve survival rates.



Figure 8: IED strike on a Coalition patrol, Southern Afghanistan 2011.

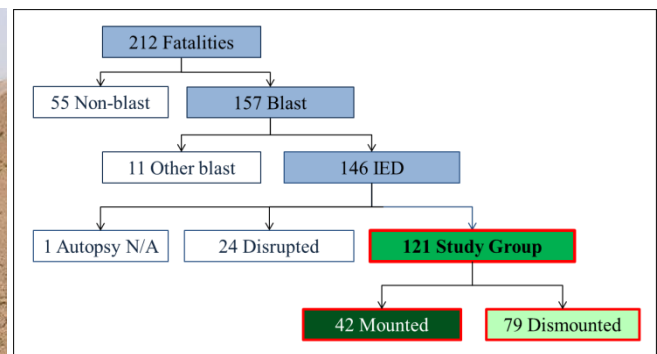

Figure 9: Study group composition.

## Patients and Methods

Since November 2007, UK Armed Forces personnel killed whilst deployed on combat operations have undergone both a full post mortem computed tomography (PM-CT) scan at the deployed military hospital and an autopsy once repatriated to the UK. With the permission of Her Majesty's Coroners and UK Joint Medical Command, analysis was conducted of casualties with PM-CTs between November 2007 and July 2010. Injury data were analysed by a pathology-forensic radiology-orthopaedic multidisciplinary team. All injuries were given a score using an internationally accepted system – the Abbreviated Injury Score – from 1 (minor injury) to 6 (maximal injury, currently unsurvivable). Cause of death was attributed to the injuries with the highest AIS scores. Injuries with an AIS < 4 were excluded. During the study period 212 PM-CT scans were performed, containing 146 fatalities due to explosive blast from IEDs. Of these, 121 were suitable for further study: 79 were dismounted, and 42 were mounted (in vehicles) (Figure 10).

## Results

Clear differences were evident in the anatomical distribution of fatal injuries in dismounted and mounted groups as shown in Figure 10. Leading causes of death were head injury (53%), followed by thoracic injury (23%) in the mounted group, and lower extremity trauma (48%), head injury (19%) and abdominal trauma (13%) in the dismounted group.

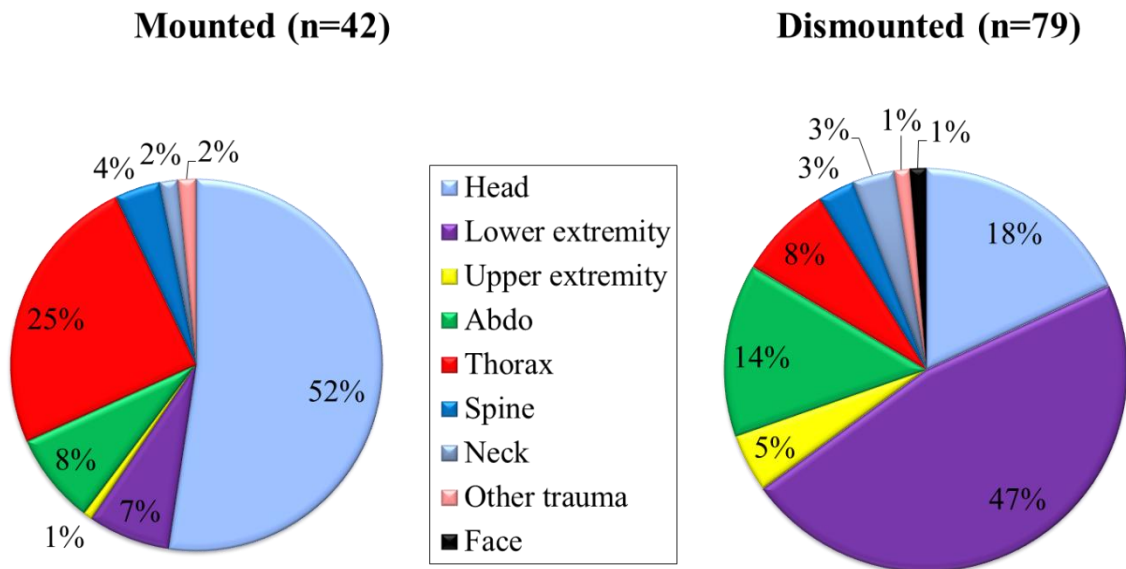

Figure 10: Lethal injuries by anatomical region.

Further analysis was performed by calculating *mechanism* of death for every fatal injury (AIS  $\geq$  4). Haemorrhagic injuries were classified as extremity (amenable to tourniquet control), junctional (potentially amenable to compression), or intra-cavity (requiring surgical haemostasis). It was necessary to amalgamate anatomically separate groups into unifying mechanistic groups. This helped to clarify intra-group trends and facilitate inter-group comparison; we combined groin, neck and axillary haemorrhagic injuries to form an overall junctional haemorrhage group. Upper and lower limb haemorrhagic injuries constituted the extremity haemorrhage group. Intra-cranial, Intra-thoracic and intra-abdominal bleeds made up the intra-cavity haemorrhage group. Head and spinal neurological injuries contributed to the CNS injury group. These results are shown in Figure 11.

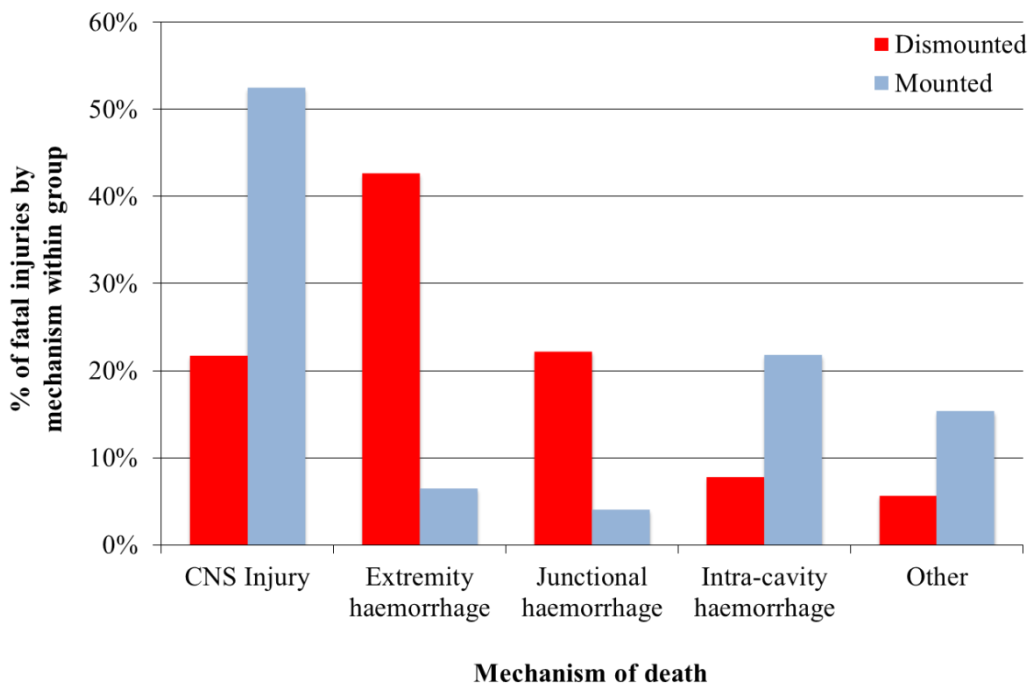

Figure 11: Mechanism of death in mounted and dismounted fatalities.

## Conclusion and Future Work

This research has described the fatal injury profile due to IEDs for both dismounted and mounted casualties for the first time. It is the largest series of IED fatalities reported to date with comprehensive CT and autopsy records. Studies such as this are invariably retrospective due to the constraints of battlefield trauma research, but meaningful analysis is still achievable – indeed there is an imperative to analyse fatality data to minimise future potential loss of life.

The severity of head trauma in both mounted and dismounted IED fatalities would indicate that prevention and mitigation of these injuries is likely to be the most effective strategy to decrease their resultant mortality. Two thirds of dismounted fatalities have extremity and junctional (groin/axilla/neck) haemorrhage implicated as a cause of death that may have been amenable to pre-hospital treatment strategies. One fifth of mounted fatalities sustained lethal intra-cavity haemorrhagic trauma which currently could only be addressed surgically. Maintaining the drive to improve all haemostatic techniques for combat casualties from point of wounding to definitive surgical proximal control alongside development and application of novel haemostatics could still yield a significant survival benefit.



# Development of Technologies to Study Blast Injury

## Traumatic Injury Simulator (AnUBIS)

AnUBIS (Anti-vehicle Underbelly Blast Injury Simulator) is a pneumatically driven device able to accelerate a 42 kg plate up to velocities seen in the floor of vehicles when targeted by a mine (Figure 12). AnUBIS is able to simulate the loading environment a vehicle occupant's leg will face robustly and repeatably (Figure 13). Combining multiple-sensor data, high speed video, and medical imaging the mechanism and severity of the injury sustained by the lower limb can be quantified. This information can be used to inform and validate the computational models, to assess the effect of leg positioning on injury severity, to assess the biofidelity of surrogates, and to assess the effectiveness of full-scale mitigation technologies in reducing injury severity.

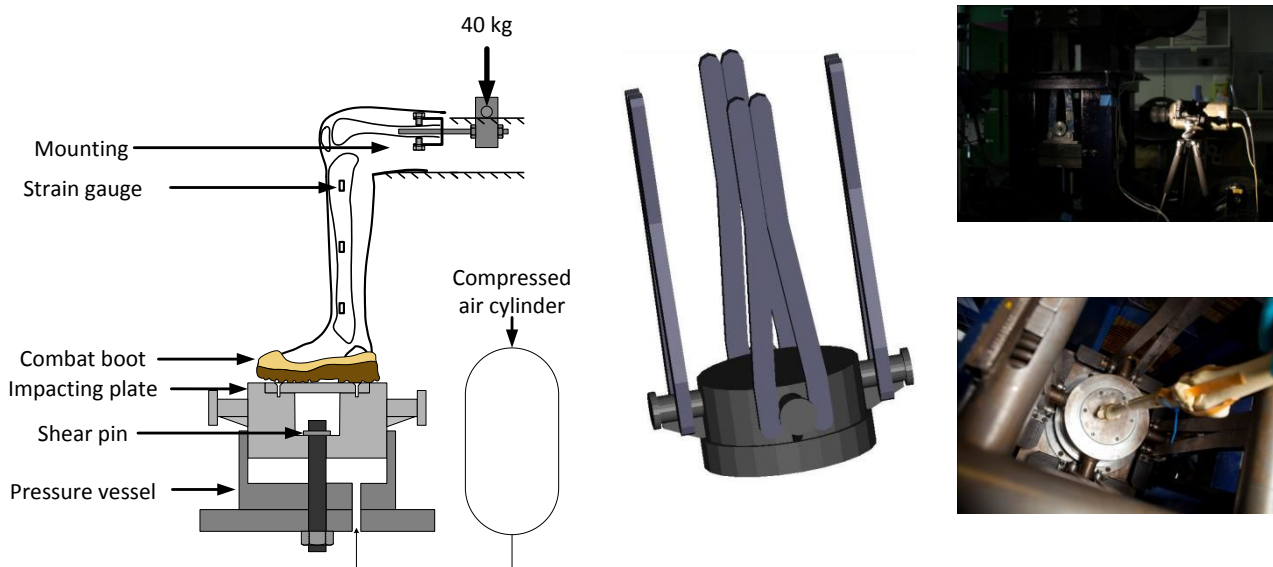

Figure 12: Our traumatic injury simulator (AnUBIS) is able to simulate the loading environment seen in AV-mine blasts.

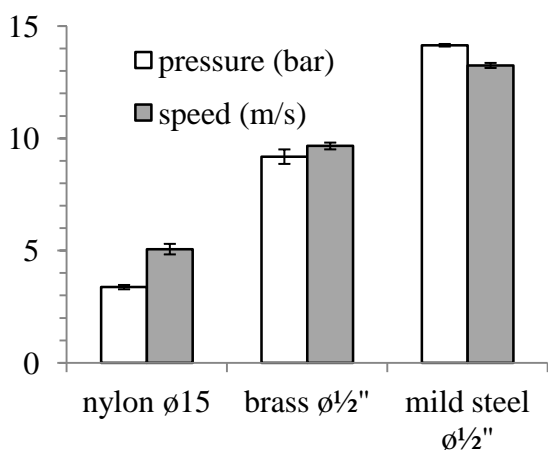

Figure 13: Pressure at plate release and maximum plate speed achieved for various shear pin materials and diameters.

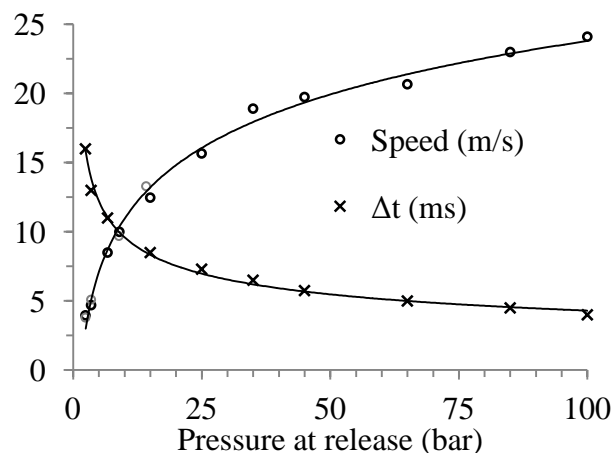

Figure 14: Operational map of AnUBIS. Maximum speed of the plate and time elapsed to maximum speed against pressure at release.

## The Shock Tube

A shock tube is a laboratory device able to generate a well-defined pressure output of varying intensity and duration (Figure 15). Therefore, it can surrogate blast waves in the laboratory responsible for a range of injuries including pulmonary, nerve and brain injuries. We have designed and built a shock tube in order to subject tissue (cellular and organ) to controlled pressure pulses that simulate primary blast exposure in the battlefield.

The compressed air pressurised section is separated from the low-pressure section by one or two diaphragms prepared from metallic or plastic films. As the pressure is increased behind the diaphragm, the diaphragm deforms plastically, and eventually fails. The sudden rupture of the diaphragm releases the pressure into the low-pressure section, creating a pressure wave, i.e. a shock front of compressed gas. The wave evolution along the tube is monitored using ultra high frequency piezoelectric pressure sensors. We are characterising the shock tube in order to control with accuracy its output. The variables we are experimenting with are diaphragm breakage, pressure evolution, and pressure profile in terms of intensity, shape, and duration.

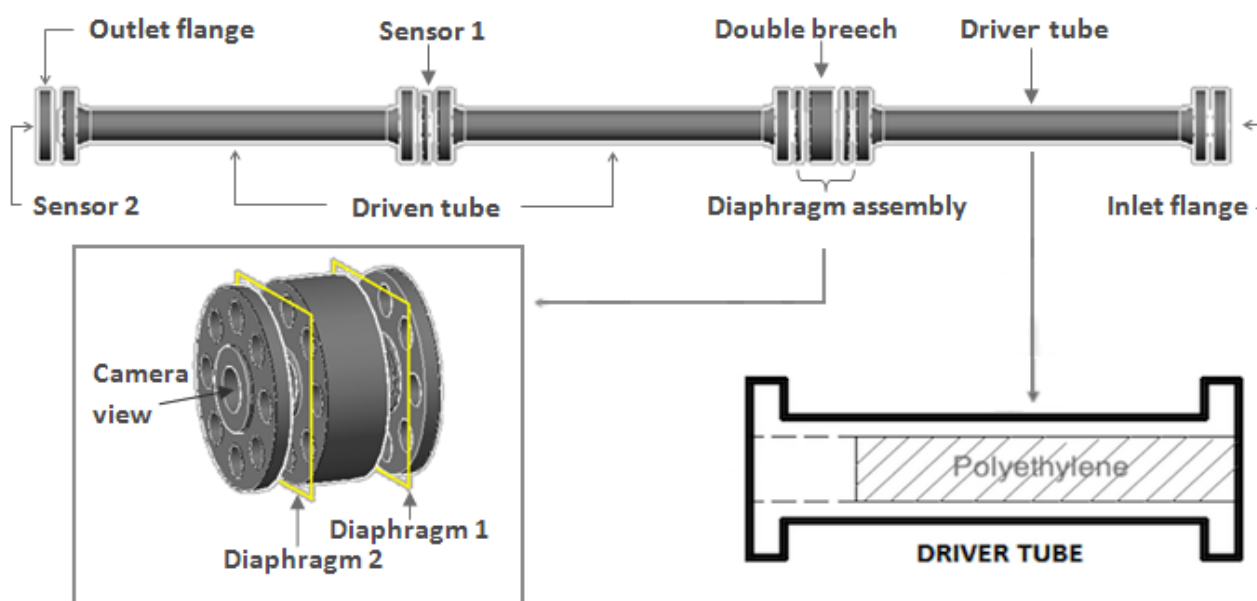

Figure 15: Shock tube schematic

Pressure is built up in the driver tube. The material of the film of the diaphragms is chosen according to the pressure pulse we want to achieve. The diaphragm fails at a set pressure and a pressure wave is released into the driven tube. The volume of the driver tube can be reduced using polyethylene inserts to modify the generated pressure pulse. Depending on the application, the sample we want to study can be placed at the locations of sensors 1 or 2.

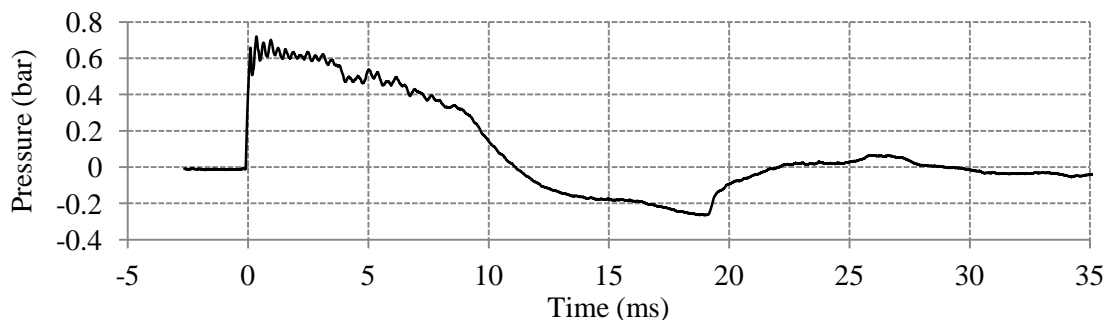

Figure 16: A typical pressure pulse produced by the shock tube. Peak over-pressure followed by a rapid decay and feeble winds is shown.

## Split Hopkinson Pressure Bar (SHPB) System With Cell-Compression Chamber

We have developed a system for applying high intensity compression waves to cell cultures using a modified Split Hopkinson Pressure Bar (SHPB) system, equipped with a biocompatible chamber that permits recovery of samples for further cellular and molecular analyses. Different chamber designs have been tested and the optimal configuration that ensures minimal volume losses and allows the measurement of the hoop strain and consequently of the inner radial stress developed during compression experiments has been chosen. The chamber design has focused on the use of suitable materials, the possibility to recover the samples after impact for further analysis, and the flexibility to perform experiments on different controlled conditions.

The experimental setup developed previously (see previous annual reports) to study the effects of pressure waves on biological samples (cells in suspension) has been further modified to allow experiments on cell monolayers (Figure 17). Adherent cells are grown on a plastic coverslip which is then mounted on support bars and fixed with plastic screws. The support bars are then inserted in the cell-compression chamber and the whole assembly is supported by a rig fixed to a rail carriage, which allows the alignment of the support bars with the input and output bars of the SHPB system. Liquid medium is inserted in the chamber as in previous experiments and the chamber is then sealed with an o-ring and a plastic screw.

Briefly, the experiment can be described as follows (Figure 17): a pneumatically-operated projectile impacts the input bar of the SHPB system thus generating a stress wave. This wave travels along the input bar and is transmitted to the support bar on which the coverslip is mounted, the liquid in the chamber, and the other support bar in contact with the output bar. The loading environment in the chamber is calculated by utilising the signals recorded by strain gauges mounted on the bars. Finally, the samples are recovered and different assays (e.g. survival, fluorescent microscopy) are performed to investigate the biological effects caused by the applied pressure pulses.

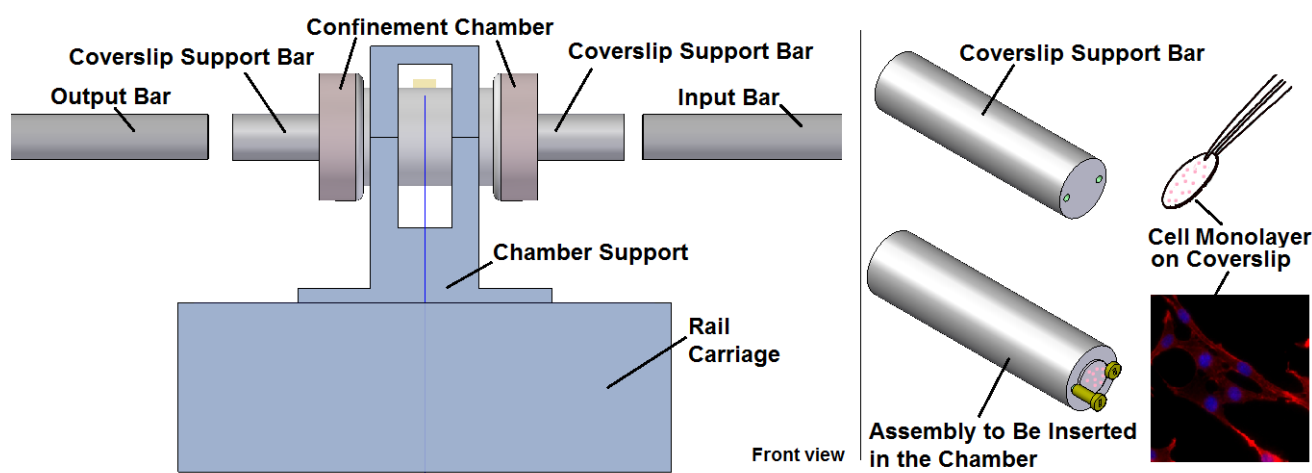

Figure 17: Confinement chamber set up for experiments in our modified split Hopkinson pressure bar (SHPB) with cell monolayers.

## In Vivo Models

Most of neurological diseases are accompanied by gait changes. Therefore, understanding locomotion in an *in vivo* model can provide an objective measure for nerve dysfunction and recovery. An appropriate facility was established and a robust protocol for measuring *in vivo* kinematics and gait dynamics during treadmill walking was defined. The DigiGait™ imaging system (Mouse Specifics, Boston, MA) is used for characterisation of postural and kinematic metrics, and an optical motion tracking system (Vicon, Oxford, UK) to measure joint kinematics.

Both systems were used in a pilot study. Mean gait parameters were similar to the normal range reported in the literature during treadmill walking. Left and right stride lengths were almost identical, indicating that the weight was being distributed equally (Figure 18). The range of the motion recorded with the Vicon system for the hip, knee and ankle joints was within the values reported in the literature and consistent between different sessions (Figure 19). Based on these findings, the methodology for measuring dynamic gait and kinematics in this model is reliable and objective. This experimental platform can now be used to characterise the locomotion for various pathological and recovery states.

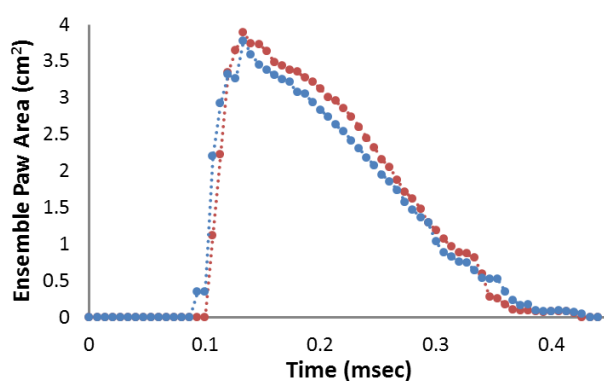

Figure 18: Ensemble areas showing coordination of limbs.

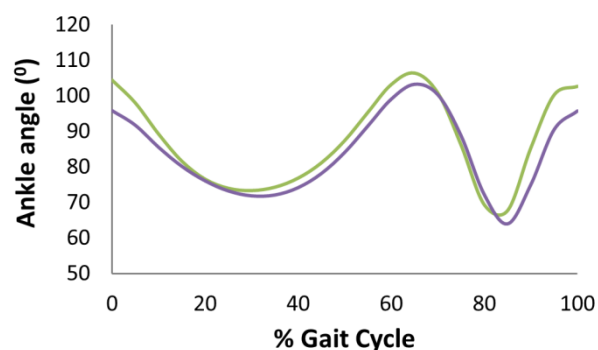

Figure 19: Mean flexion (-ve)/extension (+ve) angles, during two different testing sessions (represented by the different colours).

## Computational Modelling

Experimental and computational models of human injury and of mitigation technologies are necessary in order to understand the physical mechanisms involved and to allow for developing new and improved evaluation criteria, techniques, materials and designs in a cost-efficient manner. Full scale experiments (e.g. the combat boot, the vehicle, the human leg or head) give us an understanding of the whole 'structure' under fairly controlled, repeatable conditions; however, these are expensive, time consuming and labour intensive, albeit invaluable. Individual-component experiments (materials testing of components of structures) are well controlled and repeatable, allowing us to understand component behaviour, and therefore to build accurate computational models able to predict the behaviour of the 'structure' based on the interaction of its components. Computational models that have been validated against relevant experiments allow for multiple virtual experiments to be conducted in a cost-efficient, repeatable, well-controlled manner. They allow us to alter inexpensively parameters related to geometry, materials, and environment and look at their effect on overall behaviour. As such, they allow us to understand behaviours at locations where we cannot physically measure, and to experiment with novel designs and material combinations that could potentially result in novel, better mitigation strategies.

In addition, computational models allow us to design bespoke experimental rigs and mounts, and get them right the first time. These models can predict location of potential failure of mounts and components, and therefore aid in the design / re-design process.

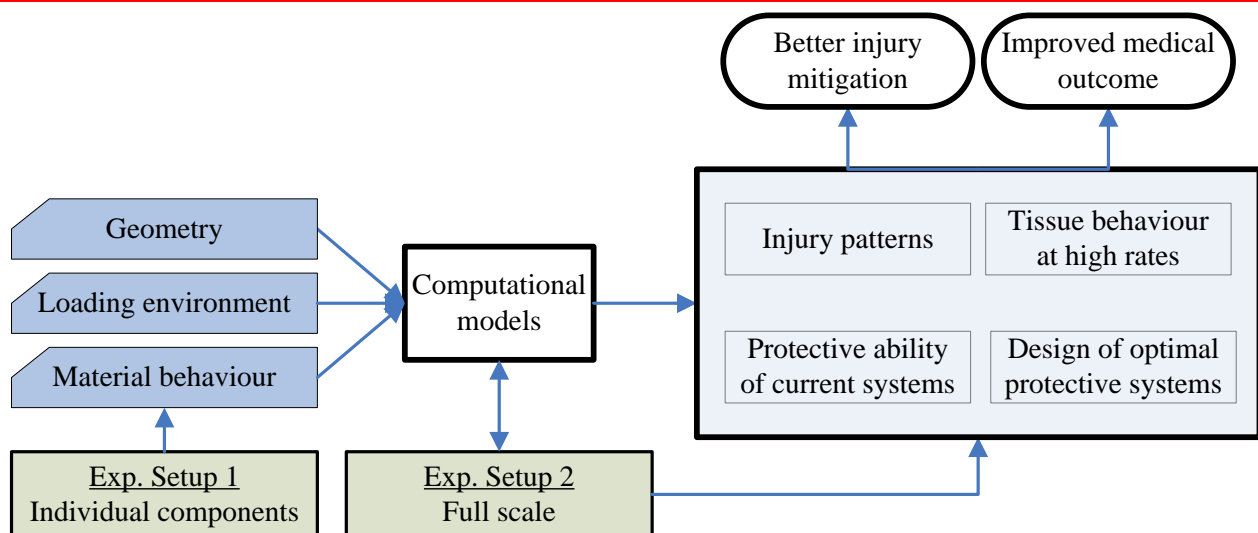

Figure 20: Modelling approach in CBIS.

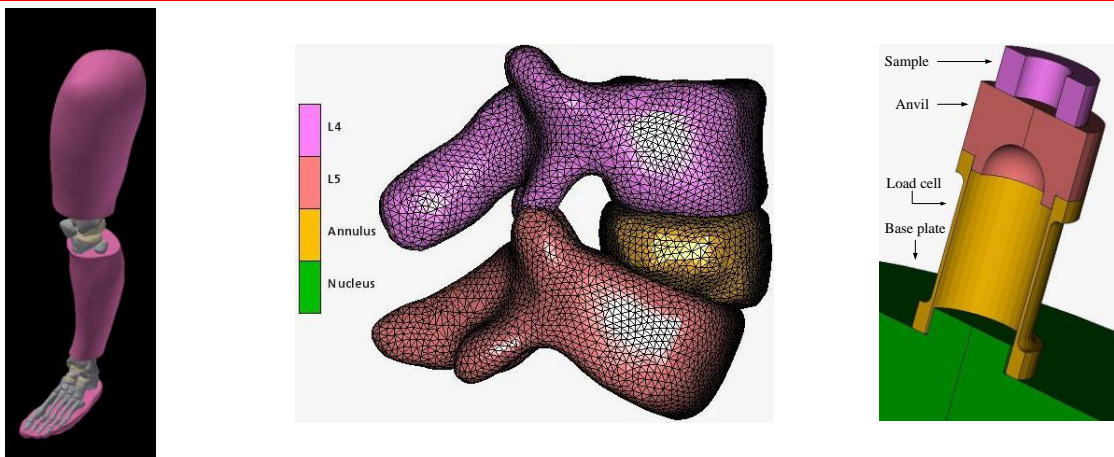

Figure 21: Examples of computational models used in CBIS. Left: Lower extremity. Middle: Lower lumbar spine. Right. Cross section of a load cell we designed for measuring bone material properties.

# Biological Tissue

## Nervous System Cellular Response to Stress Waves

### Introduction

More than half those injured by explosive ordinance present with nerve damage that persists long after the tissue damage has healed. This includes persistent pain and reduced nerve conduction which compromises sensation and control of muscles, even at sites distance from the site of injury. The cause of these deficits is not known, but since fast nerve conduction requires insulation by Schwann cells that wrap around the nerve fibres, and altered Schwann cell behavior is also associated with persistent pain, the Centre is investigating whether the response of Schwann cells to stress waves could account for the clinical symptoms. The aim of the research is to investigate the cellular and molecular mechanisms underlying the effects of stress waves on Schwann cells, with a view to developing strategies for mitigating the peripheral nerve effects in blast victims.

### Cells exposed to stress waves can affect healthy cells nearby

The relationship between Schwann cells and neurons has been identified as central to the observed clinical pathologies following blast injury. Schwann cells and neurons were harvested and purified from 3-day-old Sprague Dawley rat pups (Figure 22) and form the basis of all cellular work in this study.

Schwann cells in suspension were subjected to high intensity compression waves using the modified Split Hopkinson Pressure Bar (SHPB) system, after injection into the biocompatible chamber (Figure 17). Increasing shock wave pressure was shown to be inversely proportional to Schwann cell survival (Figure 23). Interestingly, Schwann cells surviving compression appear to have no change in growth rate over several days following compression (Figure 24).

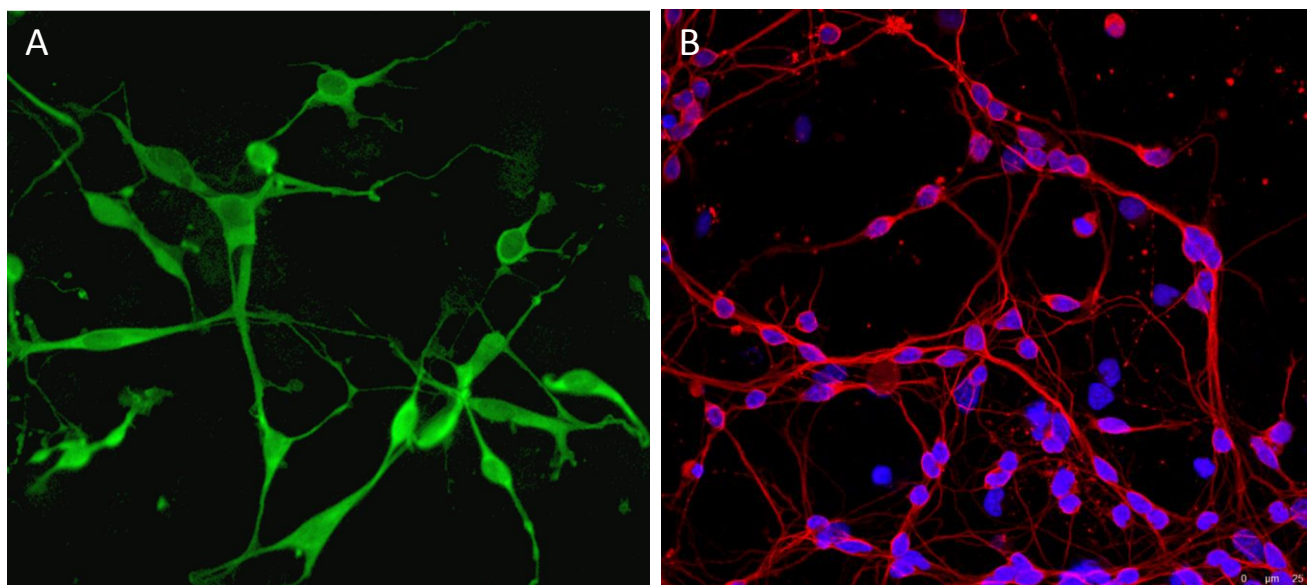
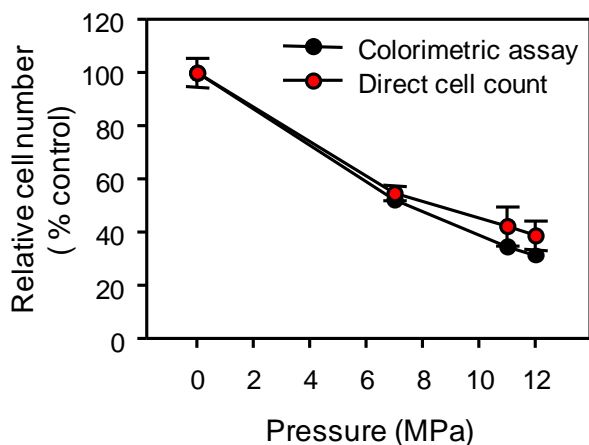
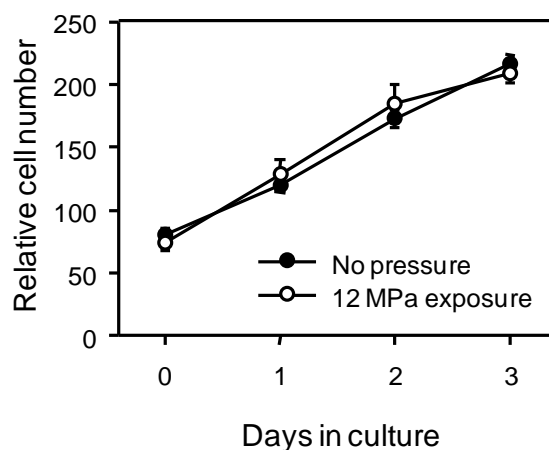

Figure 22: Fluorescent microscope images of Schwann cells (A) and Neurons (B). Cells were stained for S100 (green) a protein found on Schwann cells and  $\beta$ III tubulin (red) a protein found in neurons.

Shock waves cause severe mechanical injury to cells, resulting in rupturing of the cell membrane (lysis), causing cell death. This leads to a mass release of intracellular contents, which may have a biological impact on undamaged neighbouring cells. To investigate this effect, media from compressed Schwann cells (12 MPa), total cell lysate and uncompressed Schwann cells (Sham) were placed on healthy Schwann cells. Cell numbers were assessed at day 0, 1 and 2 using the MTS assay, a colorimetric assay that monitors levels of cell metabolism. Figure 25 shows that medium from cells that were exposed to a shock wave caused the healthy Schwann cells to divide more than cells exposed to control medium (Sham), whilst the total lysate was toxic to healthy Schwann cells.

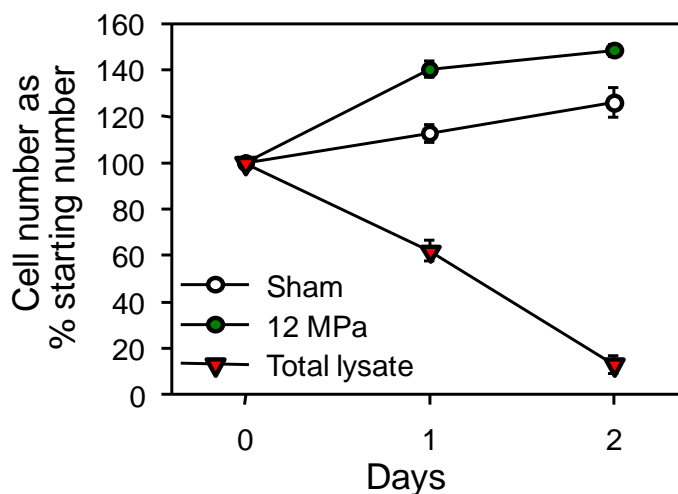

**Figure 23: Schwann cell survival is inversely proportional to pressure experienced in the modified Split Hopkinson Pressure Bar.**



**Figure 24: Schwann cells that survive the blast show no change in growth rate compared to normal cells over several days.**

This interesting finding requires further investigation to determine whether the proliferative effect of the blasted Schwann cell medium is a blast-specific effect, where the damaged cells actively secrete a proliferation-inducing molecular signal as a response to the blast, or if it is a concentration dependent effect, with high concentrations of the active intracellular molecule leading to cell death, and low concentrations stimulating Schwann cells to divide (which would compromise their insulating, nerve conduction role).



**Figure 25: Media taken from cells subjected to a shock wave increases proliferation in healthy Schwann cells. Total lysate of Schwann cells is toxic to the healthy Schwann cells.**

## Cellular Resistance of Adherent Cells to Stress Waves

The existing SHPB setup has been designed and optimised for accommodating cell cultures in suspension. However, cells in tissue grow in three dimensions, adhering to neighbouring cells via important cell-cell interactions. These are vital for the long-term survival of the cells and their function within the tissue. Moreover, neurons cannot be maintained in suspension, so investigation of this important cell type requires adherence. Cells can be grown in 3 dimensions using synthetic scaffolds; these scaffolds can be introduced to the SHPB for testing.

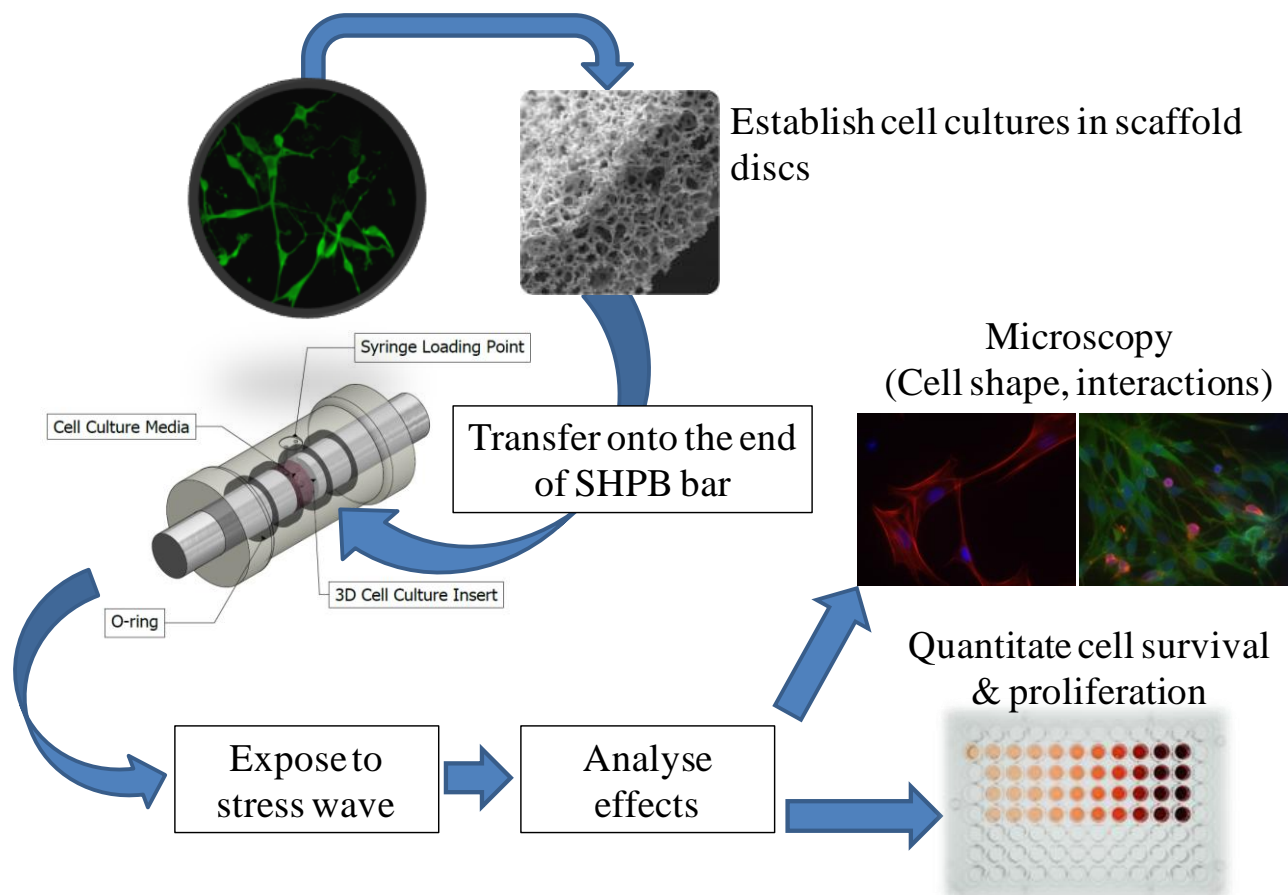

**Figure 26: Schematic outlining the use of the SHPB with adherent cell cultures grown in 3D scaffolds.**

Neurons were seeded into nanofibre solutions™ scaffolds and cultured for three days. The scaffolds were inserted into the SHPB chamber and subjected to an 8 MPa pressure pulse. The pressure traces of the SHPB were not affected by the addition of the scaffolds to the chamber (Figure 27). The relative number of live neurons following exposure decreased as seen with Schwann cells in suspension, demonstrating the validity of using 3D culture techniques with the SHPB (Figure 28).



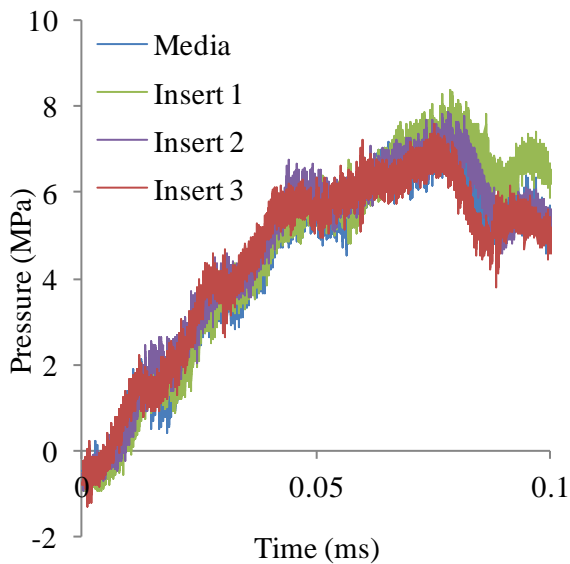

**Figure 27: Nanofibre inserts seeded with neurons survive compression in the SHPB and do not affect the pressure trace.**

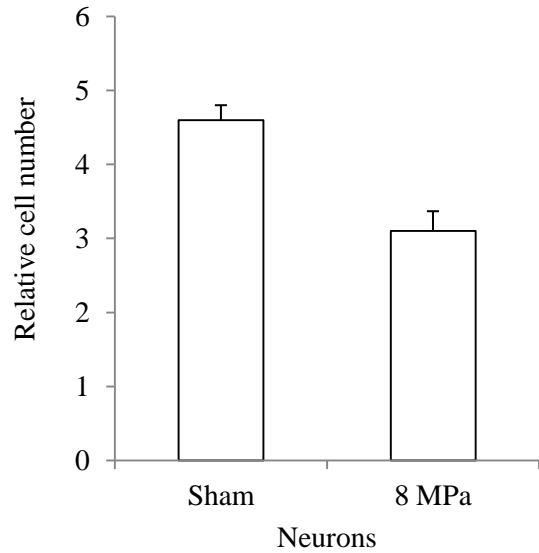

**Figure 28: A reduction in number of living neurons grown in 3D occurs following exposure to an 8MPa stress wave.**

## Conclusions and future work

The SHPB and cell culture chamber can be used successfully for subjecting cultures of clinically relevant cells to shock waves. Blasted Schwann cells release factors (probably via cell lysis) that can stimulate undamaged cells to proliferate (low concentrations) or die (high concentrations). This could account for the Schwann cell behaviour observed in animals following compression or exposure to shock waves. Identification of the agent(s) responsible for these effects would inform possible therapeutic strategies for mitigating conduction deficits and neuropathic pain following blast injury.

The use of synthetic scaffolds for 3-dimensional cell culture allows the SHPB platform to accommodate adherent cell cultures, and the viability of Schwann cells and neurons remains high when cultured in scaffold discs for several days. Scaffolds were undamaged following exposure to a shock wave and the pressure trace was not altered by the presence of the scaffold in the chamber. A preliminary blast experiment with neurons in a scaffold disc showed that cell number following blast was readily quantifiable using the MTS colorimetric cell number assay. The use of 3D adherent cultures will allow us to investigate the morphological changes of cells following blast, in particular the changes to crucial cell-cell interactions. It will also allow us to develop complex co-cultures of neurons and Schwann cells, providing a clinically relevant model for investigating the effects of blast at a cellular level.

## Nerve Injury

### Introduction

Approximately 13% of extremity injuries of blast casualties are associated with peripheral nerve injury, often distant to the site of direct impact and without visual physical damage to the affected limb. We examined the effect of nerve palsy to normal and impaired gait using our *in vivo* model described earlier.

### Materials and methods

*In vivo* gait was assessed using standard gait analysis techniques on a treadmill at different speeds during (a) normal locomotion, (b) 30 min after a transient sciatic nerve block was induced by injection of local anaesthetic near the left hip that temporarily numbed the sciatic nerve, and (c) 90 min post injection after recovery.

### Results

During normal gait dynamic parameters were within the range reported in the literature for treadmill walking. The stance phase duration was found to decrease as the speed of the treadmill belt increased. The swing phase duration remained relatively constant. At 30 minutes after the nerve block maximum gait speed was reduced and the affected limb had a significant reduction of the contact area on the treadmill over time ( $p < 0.05$ ). This led to a decrease in the stance phase duration of the left limb and an increase in the stance phase of the contralateral (right) limb. At 90 minutes after the nerve block was induced all gait parameters had returned to normal.

Kinematic waveforms during normal gait were similar across the different speeds; however, as the speed increased the joint angle graphs were shifted to the right showing a shortened stance phase. After the transient nerve block was induced, the range of motion of the left ankle and knee joints significantly decreased compared to normal gait, and at the same time, the range of motion of the contralateral ankle joint increased (Figure 29). After recovery the mean range of motion was similar to those recorded during normal gait; however, in the ankle joint there was a noticeable decrease in the peak extension and flexion angles during the stance and swing phases respectively ( $p < 0.05$ ), suggesting that minor walking deficits were still present.

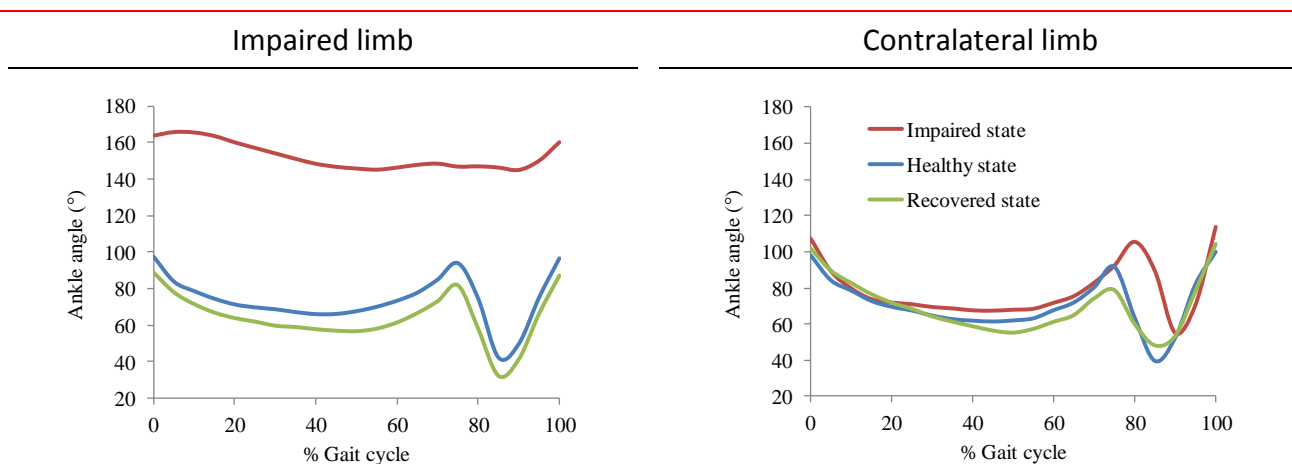

**Figure 29: Mean flexion (-ve) / extension (+ve) angles for the ankle joint showing the effect of the nerve block on the impaired limb (left) and the contralateral limb (right).**

### Future work

We are now working towards using the shock tube to simulate blast injury to the nerve for use within the *in vivo* model. Assessment of the walking pattern and nerve function will provide significant information on why intact nerves can dysfunction after exposure to blast.

# Response of Mesenchymal Stem Cells (MSCs) to Stress Waves

## Introduction

One specific complication that can develop in traumatised limbs from blast wounds is heterotopic ossification, aberrant bone formation outside the skeletal tissue. Understanding the cellular effects high-intensity compression waves (HICWs) induce in human tissues is a critical step towards developing improved therapies for blast casualties. Mesenchymal stem cells MSCs are multipotent cells with the ability to differentiate, following appropriate stimulus, into a variety of cell types. Chondrocytes (cartilage cells), adipocytes (fat cells) and osteoblasts (bone cells) are the most common of the MSC-derived cells. It is hypothesized that HICWs can lead to cellular or molecular changes to MSCs in the limb, resulting in the onset of heterotopic ossification.

## Materials and methods

Mesenchymal stem cells (MSCs) are selectively cultured from the periosteum and bone marrow of balb/c mice. On the day of the experiment cells are suspended in medium at a concentration of  $10^6$  cells/ml and aliquoted in eppendorfs tubes. Samples (five per condition) are divided in five groups: control, sham (cells that are inserted using a syringe in the SHPB chamber and recovered without being subjected to a pressure wave), blast 1 and blast 2 (cells that are inserted in the SHPB chamber, subjected to pressure pulses of respectively 5 and 12 MPa and then recovered) and freeze/thaw (which consist of two rounds of freezing and thawing the samples to obtain a total cell lysate). Cell count post recovery, acute MTS assay, and Lactate Dehydrogenase (LDH) release are among the assays performed to quantify the effects of the high intensity compression waves on MSCs.

## Results

The pressure achieved inside the chamber in a compression experiment can be calculated from the signal recorded from strain gauges mounted on the SHPB bars. Typical traces from experiments performed varying the firing pressure of the projectile are shown in Figure 37.

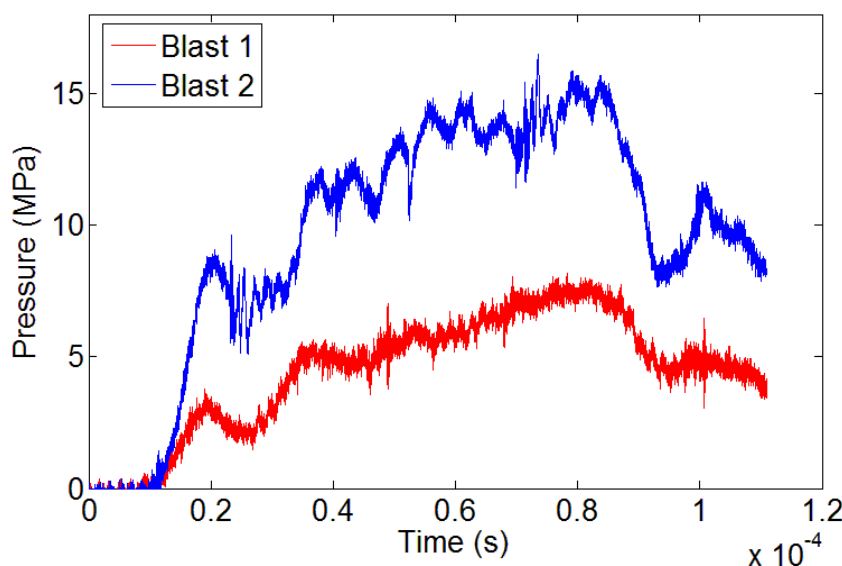

Figure 30: Typical pressure traces experienced by the MSCs in the chamber for different projectile impact velocities

Blast 1 - impact velocity = 3.5 m/s

Blast 2 - impact velocity = 7.0 m/s

Survival of MSCs post compression is assessed with Trypan blue cell count and measuring the cell respiration levels with MTS assay. We find that cell survival decreases as a function of the intensity of the pressure pulse (Figure 31).

Cell cytotoxicity is investigated measuring the release of LDH in the supernatant of the recovered samples. The increased level of LDH in the samples subjected to high-intensity compression waves (HICWs) suggests cytotoxicity as a percentage of cells have lysed due to the mechanical stimulus (Figure 32).

Finally, microscopy is used to investigate qualitatively the proliferation of cells post compression. Cells that survive the compression are still able to attach to a plastic substrate and can be grown in culture. Future work will focus on long term effects on proliferation and differentiation of MSCs following pressure pulses.

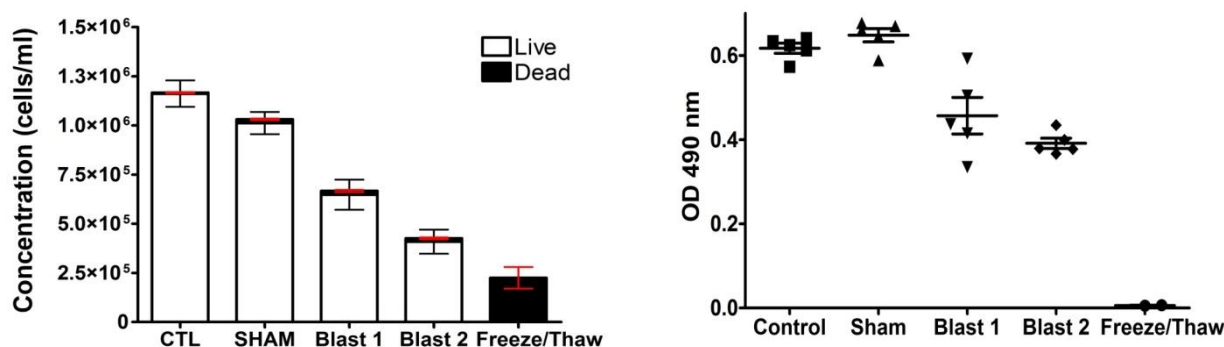

Figure 31: Cell concentration of MSCs subjected to the pressure pulses compared to control, sham samples and the total lysate obtained with freeze/thaw. Right. Cell respiration measured with a MTS colorimetric assay for the same samples as Left.

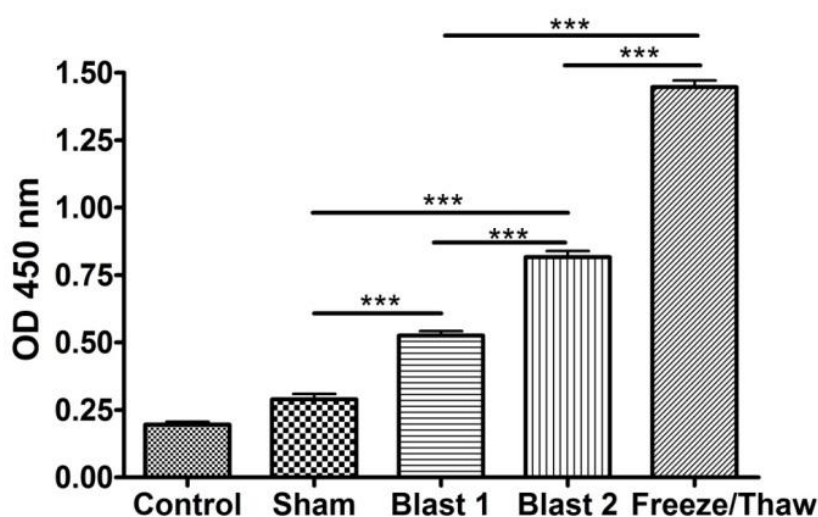
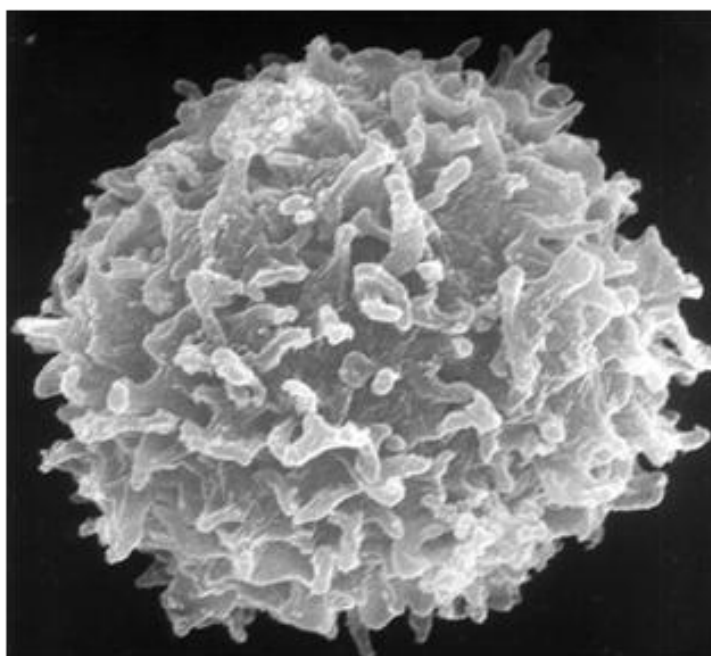

Figure 32: LDH levels in the supernatants of samples recovered post compression are measured with a colorimetric assay. The stars in the figure indicate that there is a highly significant difference between the groups.

## Response of Neutrophils to Stress Waves

Blast lung is an acute lung injury seen in initial survivors of explosions. Disease incidence can be high in this group, with incidence in the military cohorts from Iraq and Afghanistan peaking at 7.3% in 2007 and 11% in 2009 respectively. The injury is initiated by a blast wave causing thoracic acceleration and propagating through lung tissue, leading to significant immediate or delayed damage (contusions, oedema, haemorrhage). 'Blast lung syndrome' is characterised by the presence of respiratory distress, cough and hypoxia without penetrating or other blunt thoracic injury. Hypoxia is a key problem in surviving injured patients and in severe cases necessitates mechanical ventilation.

Histological characterisation of the damage caused in these injuries has revealed a number of findings, including alveolar distension and capillary rupture. Briefly, alongside a number of physiological sequelae, the leakage of blood and oedematous fluid as a result of this damage triggers an inflammatory response. Neutrophils are a type of white blood cell that play an important role in killing microbes, however in the context of blast lung, excessive accumulation of these cells at the site of injury may exacerbate tissue damage and lead to acute respiratory distress syndrome (ARDS), for this reason this study was focussed on the effect of HICWs on neutrophils.



**Figure 33: Scanning electron micrograph of a neutrophil**

The first experiments set out to investigate the effect of HICWs on neutrophil viability. It was found that exposure of neutrophils in suspension to a HICW led to >50% loss of cells, indicating a direct effect of the HICW on cell integrity (Figure 34).

Microparticles are small particles derived from cells which are believed to exert a range of physiological functions, implicating them in a wide-range of diseases including acute lung injury. To investigate whether HICWs can promote the release of microparticles from neutrophils, the media in which the cells were suspended for the blast was analysed by flow cytometry, utilising a method developed in the laboratory for this purpose. Large numbers of microparticles were released following exposure to HICWs (Figure 35). In addition to microparticles, the media of blasted MSCs could stimulate the directional migration of neutrophils (Figure 36). Further, this migration was partially inhibited by selectively blocking CXCR2 receptors that mediate neutrophil recruitment in response to the chemokine KC, to sites of inflammation. This suggests that the damage to cells,

caused by the initial blast wave could release products that promote the recruitment of neutrophils from the blood into tissues such as the lung, driving the inflammatory response.

Initial results indicate that exposure of neutrophils to a single HICW in the order of 10 MPa for  $10^{-4}$  s destroys more than 50% of the cells and stimulates the release of large numbers of microparticles. Further, neutrophils migrated in response to the products released when cells are destroyed by HICWs.

In light of these findings damage to the lungs is now being investigated using lung cells (pneumocytes) and tissue in both the SHPB and shock tube. Future experiments will enable the investigation and characterisation of the mediators released following lung injury, and to explore the functional effect of these mediators. Collaboration with the Royal Brompton Hospital will enable us to access human tissue for experiments when necessary. Through better understanding of the underlying pathophysiology, the Centre aims to offer new insights into how improved diagnostic or therapeutic interventions for blast injured patients could be realised.

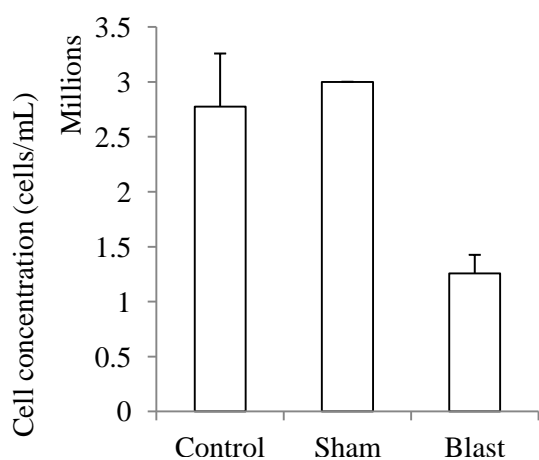

**Figure 34:** Cell counts of neutrophils when left in suspension (control), transferred to the SHPB but not subjected to HICW (sham) or subjected to a stress pulse in the SHPB (blast).

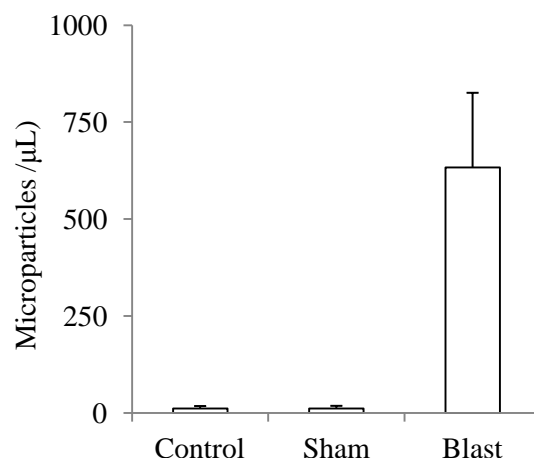

**Figure 35:** Enumeration of microparticles from different samples shows a significantly higher ( $p < 0.01$ ) number in blast samples compared to controls.

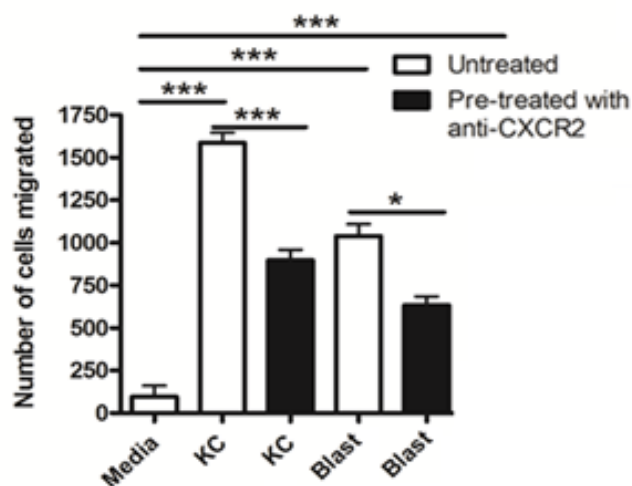

**Figure 36:** Chemoattractive activity of supernatant of blasted MSCs. This activity was diminished when responding neutrophils had a receptor for chemotaxis (migration) blocked (CXCR2), suggesting that certain mediators within the supernatant were acting through CXCR2.

# Tissue Models of Blast Injury

## Introduction

Tissue damage from blast injuries can be both severe and compound. Understanding how tissues respond to high loading rates is important for developing models that explain injury patterns, and for creating testable experimental systems to understand the basis of post-traumatic complications observed at wound sites. It is postulated that similar tissues extracted from different anatomical areas may respond differently at high strain rates that correspond to conditions leading to blast injuries. Comparative dynamic loading studies using porcine skin extracted from the rump and the thigh were therefore carried to explore this hypothesis.

## Materials and methods

Skin samples were obtained from the rump and thigh of a weaned pig (6–8 weeks old), sourced from a Specific Pathogen Free (SPF) closed herd serologically negative against influenza virus. The pig was sacrificed by intravenous administration of sodium pentobarbitone (0.8 mg/ kg i.v. to effect). A rectangular sheet was harvested from each anatomical area of interest and the adipose layer was removed from each with a scalpel. Cylindrical specimens, about 8 mm in diameter, were obtained using a biopsy punch. These specimens were stored in phosphate buffered saline solution at 4°C until mechanical tests were performed. Prior to testing, each sample was positioned between two microscope slides and the thickness was measured with callipers. Compression experiments were performed with an Instron 5566 at strain rates of 0.001 and 1.0 s<sup>-1</sup>. High strain rates (6000-9000 s<sup>-1</sup>) were applied to samples placed in a Split Hopkinson Pressure Bar system as shown in Figure 37. Magnesium bars were used to reduce the impedance between the output bar and the skin samples thereby maximising signal transmission, and semiconductor strain gauges were used to record the input and output signals.

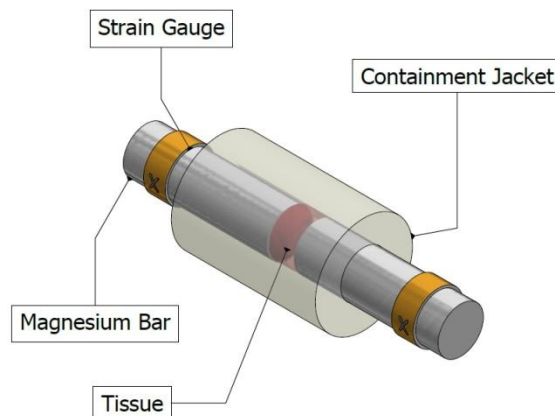

**Figure 37: Cylindrical tissue sample.**

**Sample shown in pink, is positioned between two magnesium bars fitted with strain gauges in the Split Hopkinson Pressure Bar system. A custom-made polycarbonate jacket is shown for bio-containment of samples during the experiment.**

## Results

The mechanical response of skin to compression is strongly dependent on the loading rate and on the location from which the samples were collected. Specimens collected from the rump showed a stiffer response compared to samples harvested from the thigh (Figure 38).

Data were fit using a modified Ogden hyperelastic model, which allows one to describe the non-linear stress-strain behaviour of complex materials such as biological tissues. Using this model, shear stress ( $\mu$ ) and the strain-hardening exponent ( $\alpha$ ) were calculated by fitting the experimental data using a least-squares method. These preliminary data suggest that the shear stress increases as a function of the strain rate, which is in agreement with previously published studies. The study described here also appears to be the first to characterise the different mechanical responses of skin harvested from different parts of the body. The findings suggest that biofidelic models of blast injury will be more accurate if they incorporate information about the mechanical properties of tissues specifically located at the blast injury site because even the same type of tissue from different anatomical locations can vary in its stress-strain behaviour.

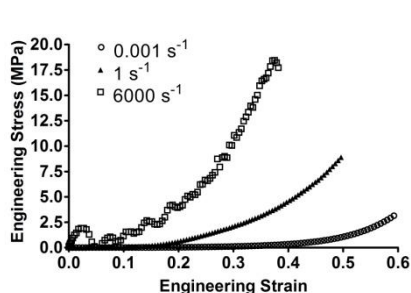

Strain rate (/s)	$\alpha$	$\mu$
0.001	10	0.081
1	10	0.897
6000	10	5.861

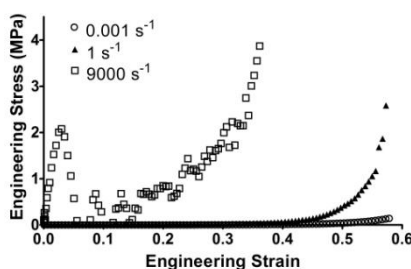

Strain rate (/s)	$\alpha$	$\mu$
0.001	12	0.002
1	12	0.027
6000	12	0.882

**Figure 38: Averaged stress-strain curves for skin from porcine rump (top) and thigh (bottom). Ogden model parameters (for input to computational models) obtained from a least-squares fit of the experimentally derived data.  $\alpha$  strain-hardening and  $\mu$  (shear stress).**

## Future work

This research programme is expanding to include similar characterisations of other tissue types that are closely associated with blast injuries of extremities and of the respiratory system. An established *ex vivo* organ model of trachea infection is also being adapted to study how this organ functions in response to blast exposure. To apply shock forces to the trachea tissue, we are modifying the CBIS shock tube apparatus to accommodate tissue samples mounted in agar media. Future studies will also include histological analyses of blast-exposed tissue samples using state-of-the-art facilities located in the Department of Veterinary Medicine at the University of Cambridge. Performing these analyses will enable correlations between structural changes seen in the histological analysis of these tissues, changes in biological function observed in various assays, and material properties measured under blast-loading conditions to be identified.



## The Lower Extremity

### Bone and ligament at high loading rates

Understanding traumatic mechanisms and injury patterns can aid in the prevention, reconstruction and rehabilitation of bone and ligament injury. In addition, in order for the behaviour of a computational model to be biofidelic, accurate material models of the behaviour of its components are mandatory. Whereas skeletal and soft tissue behaviour is fairly well understood in slow loading-rate conditions, this is not the case in higher loading-rate conditions, such as those seen in blast. We have tested ligament tissue and we are currently testing bone tissue across a range of loading rates in order to quantify their material behaviour.

#### Ligament

Tensile tests on ligament at target strain rates of 0.01, 0.1, 1, 10, and 100/s were conducted. A screw-driven uniaxial testing machine was used for tests at the first two strain rates, a servo-hydraulic uniaxial testing machine was used for the tests at 1/s, and a drop-weight testing machine with a custom-made impact tensile adaptor (ITA) was used for tests at 10 and 100/s. For all tests video extensometry, utilising high speed photography, was employed to calculate strain using multiple dots that were made across the ligament with permanent black ink immediately prior to testing. The results demonstrate that ligament tissue is sensitive to strain rate at lower strain rates, and that this effect reaches a threshold at approximately 1/s, beyond which further increase in strain rate does not affect the material properties (Figure 39). This is the first report to claim such finding.

#### Bone

Porcine cortical bone under three-point bending over a range of strain rates (Figure 41) was tested. A quasi-static screw-driven uniaxial testing machine was used to achieve two 'low' strain rates and a drop tower to achieve two 'high' strain rates. It was found that porcine cortical bone becomes more brittle as the strain rate increases. Tensile modulus, yield stress, and maximum stress increased with increased strain rate. However, they were similar at 10 and 100/s suggesting a threshold of strain-rate dependency, similar to that seen in the testing ligament tissue presented above. However, definitive conclusions cannot yet be drawn as the experimental methods at low and high rates are substantially different. Another experimental method to achieve intermediate strain rates is presently being developed. In addition, unfortunately, at very high loading rates the dynamic effects associated with the 3-point bending experimental setup do not allow for material properties to be calculated repeatably. This experiment is being redesigned in order to achieve the desired robustness in order to acquire properties at very high strain rates.

The compressive properties of bone are being researched by testing disks of cortical bone harvested from the human femur (Figure 40). Biaxial strain gauges mounted on the surface of the samples are used in order to capture both axial and hoop deformation.

Macro and microscopic damage to the bone above the apparent zone of injury in lower limbs subjected to high rate axial loading in AnUBIS is being investigated presently. It is hypothesised that the stress pulse transmitted proximally through the skeleton may result in damage to bone, which will result in reduction of its fracture toughness, thereby rendering it prone to failure and unable to support potential fixation at surgical reconstruction.

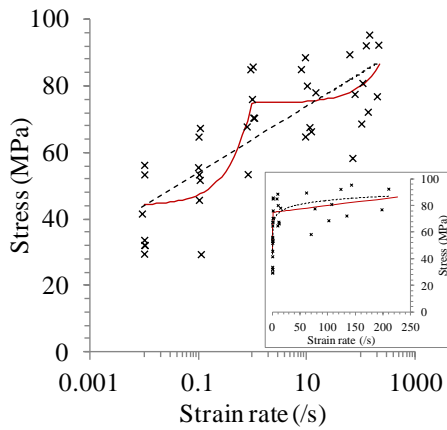
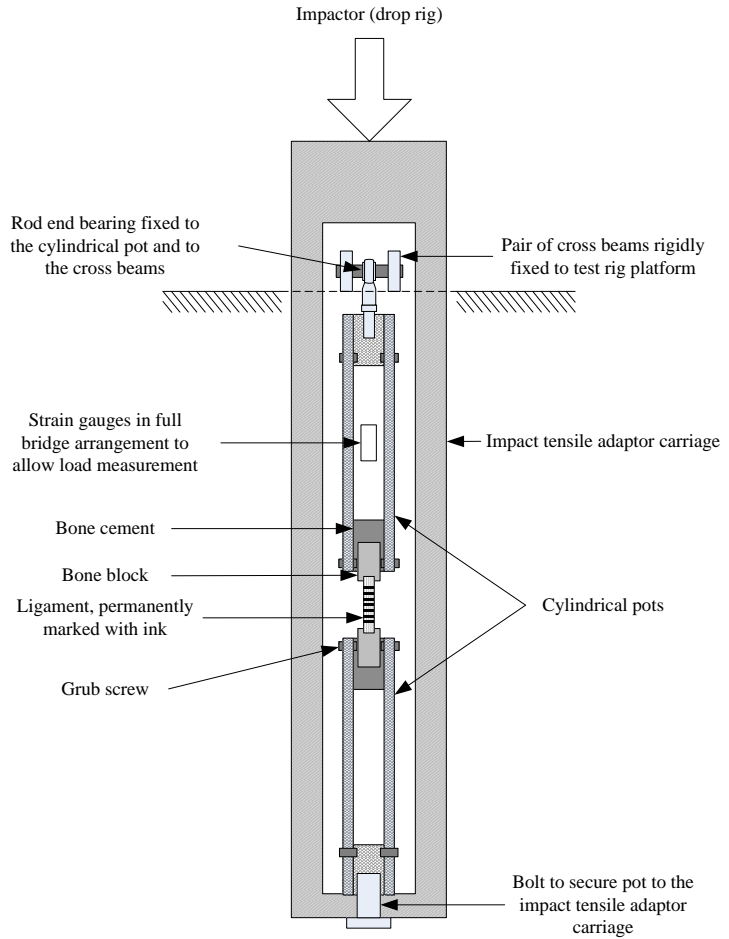
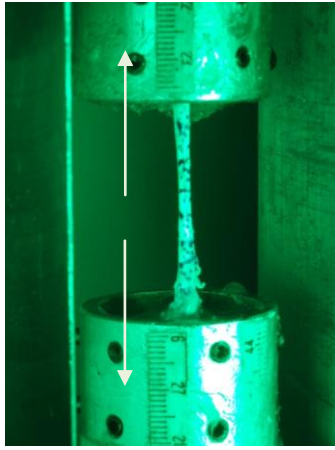

Figure 39: Knee ligament sensitivity to loading rate

Ligaments appear sensitive to loading rate up to a threshold value of approximately 1/s (i.e. deformation equal to the length of the ligament in one second). For rates up to 1/s the modulus (or resistance to lengthening) and strength of the ligament increases, but beyond rates of 1/s, modulus and strength remain relatively constant.

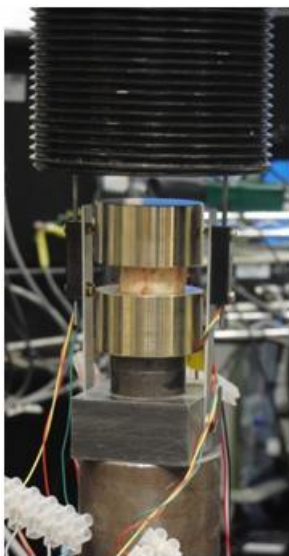

Figure 40: Cortical bone in compression.

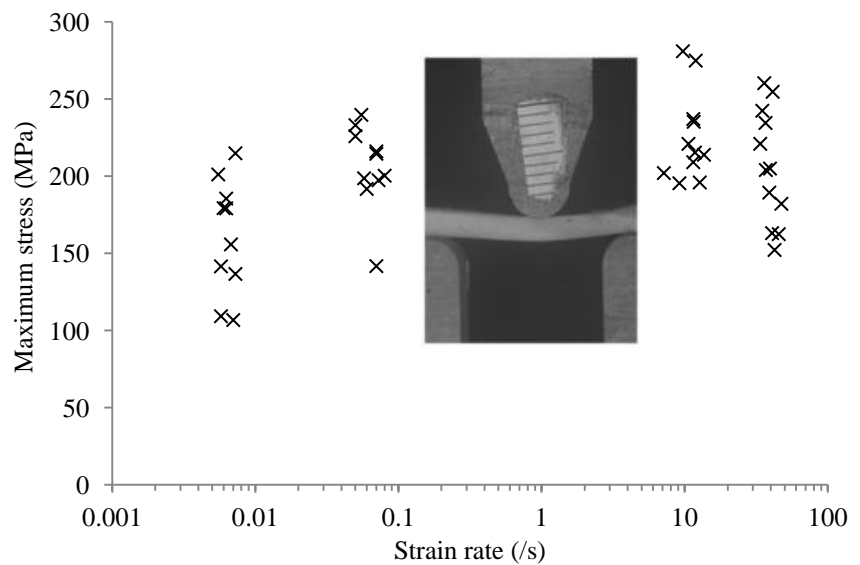

Figure 41: Stress at failure of cortical bone across strain rates in a three-point bending setup.

# Protective Systems

## Assessment of Surrogates for Protection of the Lower Extremity

### Introduction

Military vehicles are assessed to determine the level of protection they offer against the threat of anti-vehicle landmines through full-scale live blast tests. In these tests, human surrogates are used to assess body loading. The North Atlantic Treaty Organisation (NATO), who provides protocol recommendations for the full-scale live-blast tests, selected the Hybrid-III anthropometric test device (ATD) as the most appropriate existing surrogate. More recently, a new ATD lower extremity specifically designed for anti-vehicle blast research, called the Military Extremity (MiL-Lx), has been developed and is included in the most recent protocol recommended by NATO. Injury risk models determined through tests of cadaveric lower limbs have been used to assign tolerance values for the ATDs. For both ATDs these values are of the compressive force recorded at the surrogate tibia. For the Hybrid-III the tolerance value is 5.4 kN recorded at the lower tibia load cell and for the MiL-Lx is 2.6 kN recorded at the upper tibia load cell; the difference in value is due to the difference in ATD design and location of the sensor.

Both the Hybrid-III and MiL-Lx ATDs are multi-use surrogates, which are designed to represent the mass, mass distribution and geometry of the human body; however, due to their lack of frangibility and crude geometry they are simplistic representations of the complex functional anatomy of the human lower limb. Efforts to compare the response of the ATDs to cadavers are valuable to understand the limitations of these surrogates. The response of the Hybrid-III and the MiL-Lx was compared against intact cadavers in the traumatic injury simulator (AnUBIS).

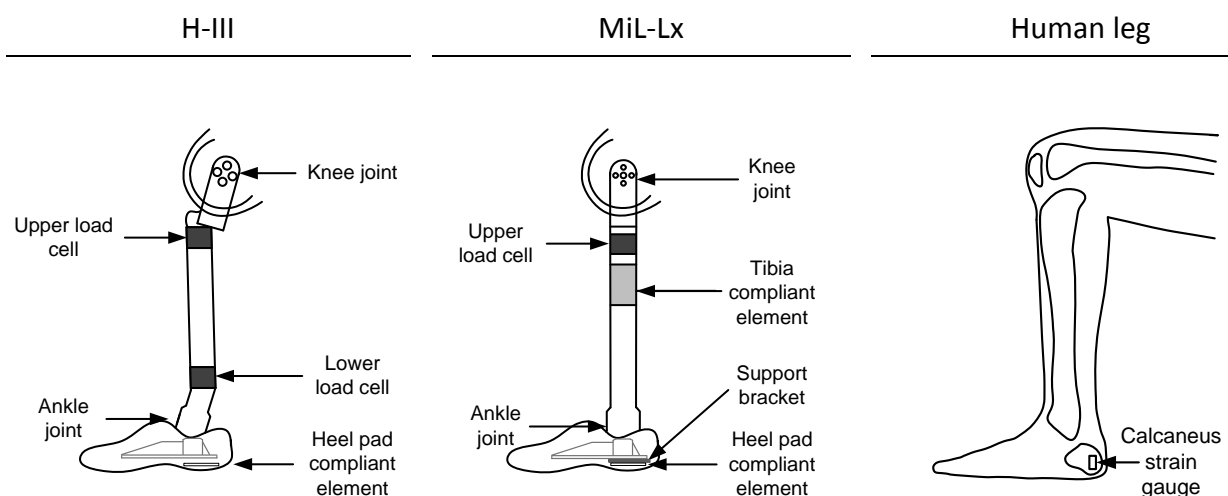

Figure 42: Surrogate geometry and instrumentation

Hybrid-III  
MiL-Lx  
Cadaveric specimen  
(Diagrams are not to scale)

### Materials and methods

The ATD or cadaveric specimen was fitted with the sole of an appropriately sized Meindl Desert Fox combat boot (Lucas Meindl GmbH and Co, Kirchanschoring, Germany) and mounted

onto AnUBIS in a seated position with the foot resting on the plate. The knee was positioned directly above the ankle and the thigh was positioned horizontally. Specimens were connected to a surrogate hip joint that allowed six degrees of freedom motion. The surrogate hip joint was loaded with 40 kg to represent a typical half-body weight. AnUBIS was operated with a 9 mm brass pin for all tests, which typically results in a maximum plate speed of ~9.5 m/s within 10 ms. The axial load was recorded in the appropriate load cell of the ATD (according to NATO specifications) and strain gauges were placed in the lateral and medial facets of the calcaneus of the cadaveric human limbs.

The behaviour of the ATDs was compared to that of the cadavers using 3 criteria; 1) the predicted injury level, 2) the time to reach peak force/strain, and 3) the combat boot compression fitted to each surrogate.

## Results

The load experienced by both the Hybrid-III and MiL-Lx was over the tolerances recommended by NATO; however, no, or just minor, injury was seen in the 3 cadaveric tests. Although the samples size in this study is small, the results suggest that further investigation into the accuracy of the injury criteria for both surrogates is warranted. MiL-Lx and cadaveric tests resulted in the same amount of combat boot compression, whereas Hybrid-III tests resulted in a substantially greater boot compression. This finding suggests that the Hybrid-III is likely to be deviating from the response of the human limb in an under-vehicle explosion. Therefore future mitigation strategies based solely on Hybrid-III experiments are likely to be flawed.

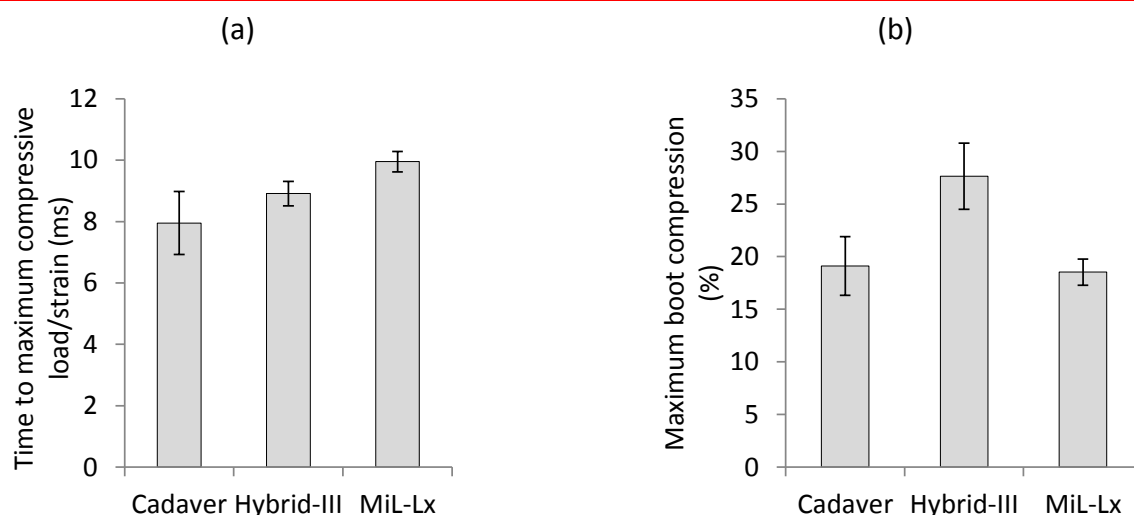

Figure 43: Comparison of the three surrogates

(a) time to maximum compressive strain for the cadaveric specimens and maximum compressive load for the ATDs

(b) maximum combat boot compression for both ATD designs and cadaveric specimens

## Future work

The different response that was demonstrated between H-III and MiL-Lx confirms findings in other international laboratories; however, the risk of injury to the lower extremity and its correlation to specific metrics of the ATDs remains a grey area. The Centre intends to conduct a full study in AnUBIS on injury risk using cadaveric specimens. This will involve a series of tests at different severities in order to assess the injury tolerance of the lower limb for comparison against the outcomes to the response of the ATDs currently available.

# Convoy Matting for Protection of the Lower Extremity

## Introduction

Convoy matting presents an easily retrofitted solution for energy absorption when a vehicle is attacked by a mine. The effectiveness of a variety of commercially available systems to mitigate lower limb injury risks was investigated using the two commonly used lower extremities of anthropometric test devices (ATDs) for vehicle tests (H-III and MiL-Lx) in both seated and standing postures at a range of impact severities.

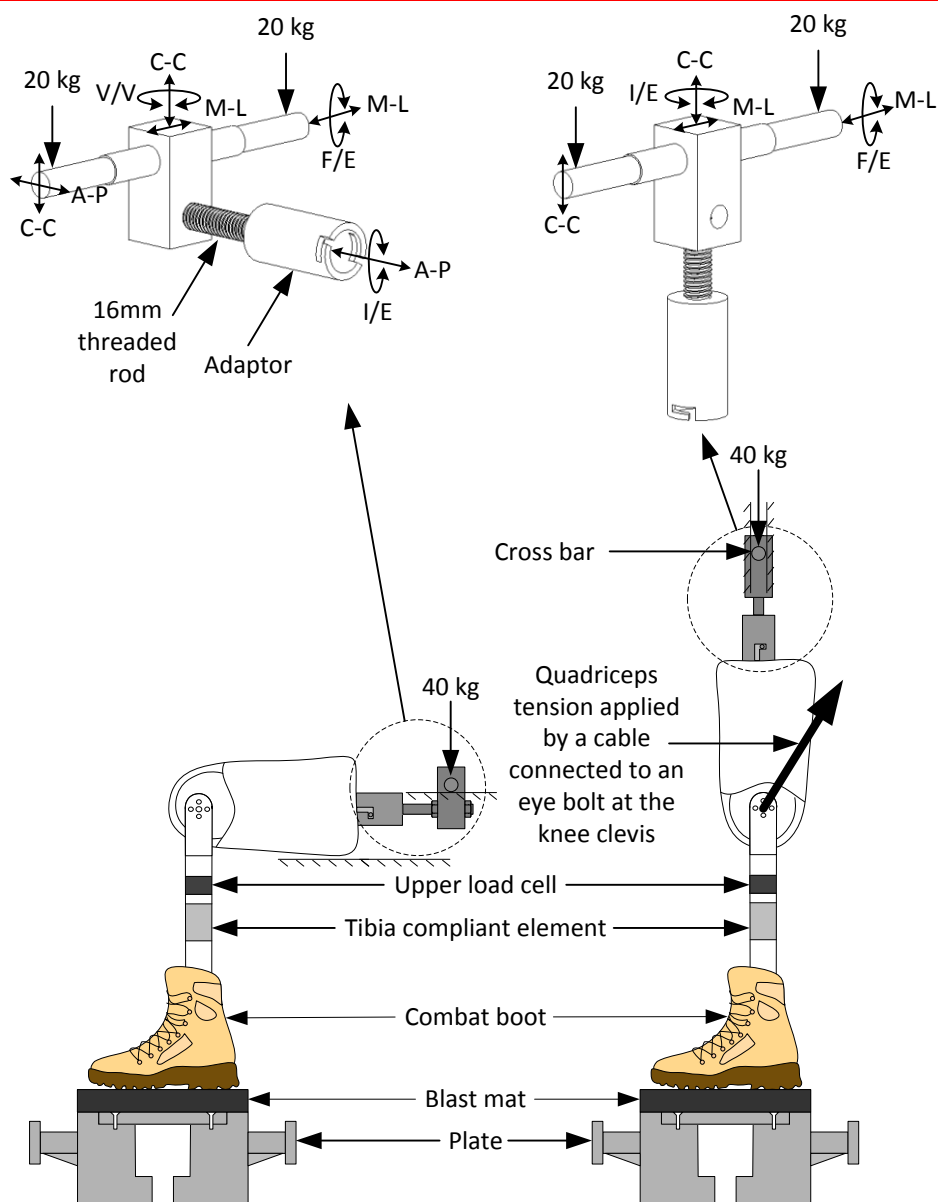

Figure 44: Configuration and mounting for (a) a seated and (b) a standing MiL-Lx leg.

The same setup was used for the H-III tests.

F/E: Flexion/Extension, I/E: Internal/External rotation, V/V: Varus/Valgus (or ab/adduction);

M-L: Medio-lateral translation, A-P: Antero-posterior translation, C-C: Cranio-caudal translation.

## Materials and methods

The tests were performed using the traumatic injury simulator (AnUBIS). The tests were performed at 3 severity levels: low, medium and high. Standing tests were not performed at the high severity level to prevent damage to the ATD instrumentation and the seated tests were not performed at the low severity level. The medium severity level was chosen based on preliminary

tests in the seated posture with no protective system in place; these tests showed that the axial force in the ATDs was just above the threshold values (5.4 kN in the H-III and 2.6 kN in the MiL-Lx) set out by NATO. The mounting for the standing and seated tests can be seen in Figure 44. The surrogate hip allows 6 degree-of-freedom (DoF) movement, albeit the leg needs to 'lift / pull' the weights that represent half a body weight in order to move. Tests were conducted at room temperature ( $22 \pm 1$  °C). Size 10 Meindl Desert Fox Combat boots were fitted to each ATD. Three blast mat designs and a confor-type foam were used.

## Results

Maximum axial forces for some of the tests are presented in Figure 45. All data are for the lower tibia in the H-III and the upper tibia in the MiL-Lx. Most blast mat designs reduced the peak force recorded in the ATDs. The differences between mitigation systems were larger under the H-III compared to the MiL-Lx. There was little difference in how the two ATDs ranked the mitigation systems. There was little difference in how posture ranked the mitigation systems.

## Conclusion and future work

There is a clear reduction in the axial load recorded in the ATD lower limbs for some blast mat designs. This suggests that retrofitting the vehicle with appropriate matting may reduce the risk of injury to the lower extremity of the occupants. Of course, there are other parameters that need considering if alteration are to be made to current vehicles, and so each potential retrofit of a blast mat should be considered on an individual basis. In addition, the results obtained from a laboratory setup have limitations, and the different behaviour of some blast mats under the two different ATDs poses questions on the appropriateness of the ATDs for assessing injury risk.

The variability in design of the blast mats tested have shown which design concepts appear to be effective in reducing the force transmitted to the occupant in a vehicle explosion. The Centre is now working towards designing a superior mitigation system.

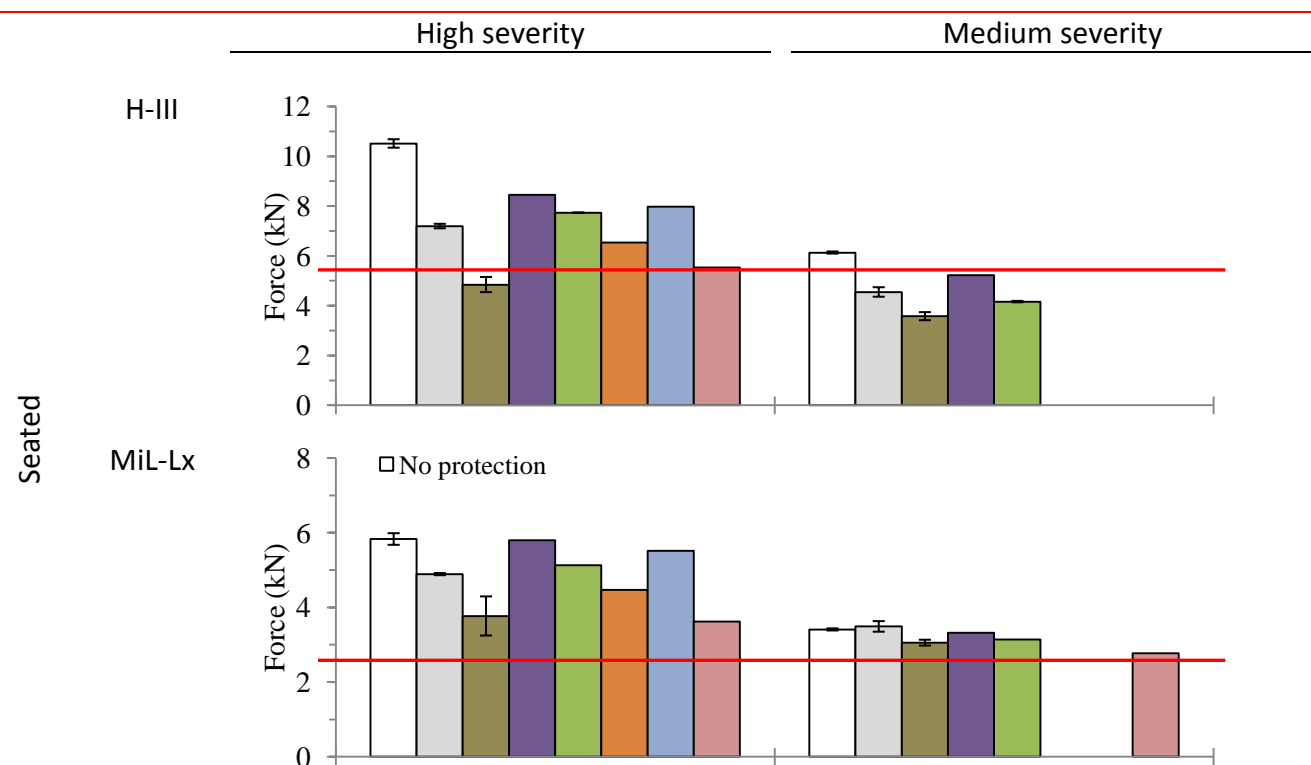

**Figure 45: Peak axial force in MiL-Lx and H-III in tests in AnUBIS. Each coloured bar represents a different blast mat design. Error bars represent  $\pm 1$  standard deviation; they are present in tests with at least 2 repeats. The red line represents the threshold load value for 'failure' (ie unacceptable injury risk) according to the NATO standard.**

## Combat Boot Behaviour - Towards Optimisation

Previously, we looked at the response of deployed combat boots under a drop tower and under the ATD platform (with both H-III and MiL-Lx) (see previous annual reports). The individual components of the sole of the combat boots have been investigated in order to understand how energy absorption in solid blast (i.e. rapid vehicle floor deformation after an explosion) can be optimised. As these materials are mostly of rubbery/foamy nature, their performance is loading-rate dependent. Tests were carried out across strain rates to understand their behaviour and computational models developed to understand the coupling with the floor and the occupant's foot.

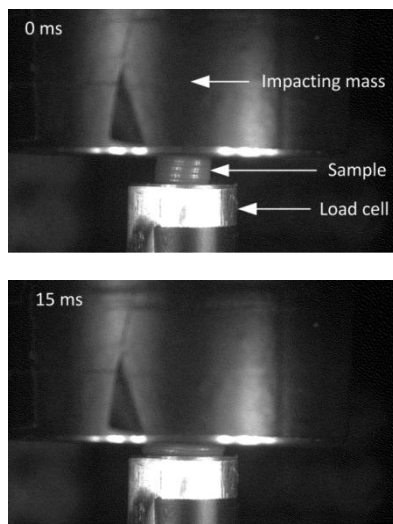

**Figure 46: Compression of components of the sole of the combat boot at high strain rates (drop tower tests).**

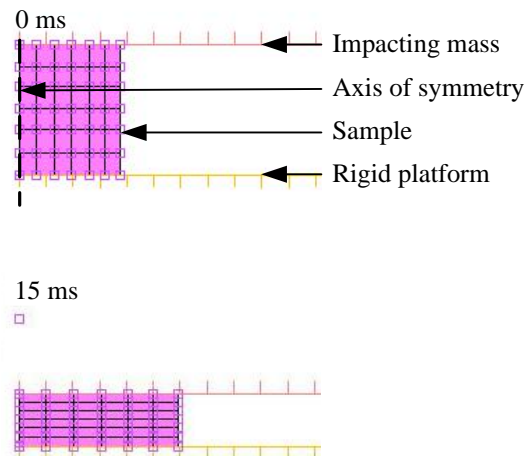

**Figure 47: Axisymmetric FE model of the compression tests of a boot component to ensure the material behaviour is modelled accurately.**

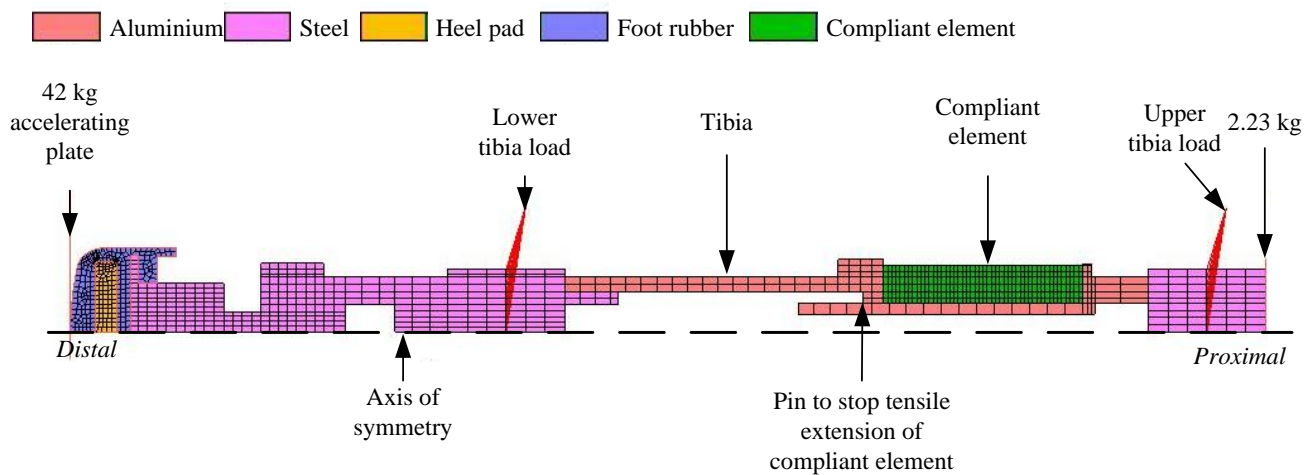

**Figure 48: Simplified, axisymmetric finite element model of the MiL-Lx ATD with the sole of the boot attached**

We are using the input from tests in AnUBIS and compare the output of the model against the output of the sensors (load cells) of the ATD in order to validate our model. The validated model can now be used to trial other material behaviours and designs of the sole of the boot in order to optimise protective capacity.

The computational models can now be used to try out different material behaviours and designs that would offer superior protection to the lower limb and reduce the risk of injury in solid blast.

## Ear Protection - Interaction Between Blast Waves and Reticular Foam

Injuries to the tympanic membrane (ear drum) and inner ear are common casualties subjected to primary blast waves in conflict. Consequently, there is a demand for improved auditory protection systems that are capable of both preventing this type of injury while providing maximum situational awareness to the user. An experimental model has been designed to allow for a number of reticulated (open cell) foams to be subjected to dynamic compression in the shock tube. Specific effects of porosity, relative density (ratio of cellular to solid material), sample thickness, incident pressure, and shock pulse of varying timescale on the evolution of peak overpressure behind foam samples are of key interest. Measuring techniques (use of Schlieren imaging techniques) are also being developed in order to examine in detail gaseous flow at the rear surface of the shocked foam samples.

---

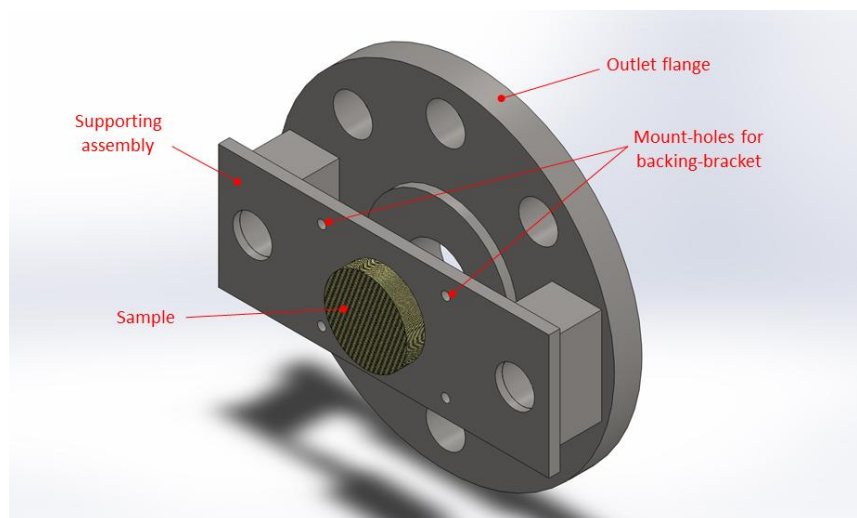

**Figure 49: Setup for reticulated foam experiments in the shock tube in order to develop ear protection**

---



## External Collaboration

### CBIS at Imperial College London

Since its foundation in 1907, Imperial has enjoyed a reputation for excellence in research and technological innovation that today attracts the most talented minds of international quality, consistently ranking the University within the top 10 in the world (top 5 in Europe). Indeed, 14 Nobel Prize winners and two Fields Medal winners are amongst Imperial's alumni and current faculty.

Imperial's unique approach to successfully answering real-world issues is founded through fostering multidisciplinary working internally, and encouraging wide collaboration externally. In doing so, it remains committed to exploring the interface between science, engineering, medicine and business, delivering practical solutions that improve the quality of life.

Imperial College London's multidisciplinary collaborations and partnerships now include internationally recognised initiatives to address Operational and National Security issues. It is for this reason that Imperial is the natural home for The Royal British Legion Centre for Blast Injury Studies at Imperial College London, founded to address the scientific issues related to the signature injuries of recent conflicts by leveraging the expertise developed through this network.

Unlike other academic institutions, Imperial College London has a clear vision to make a demonstrable economic and social impact through the translation of its research into practice both in the UK and abroad. The Centre for Blast Injury Studies is uniquely placed to achieve these aims by collaboration with professionals from many different world-leading departments within the College. The multidisciplinary work has already engaged internationally renowned experts in the fields of Bioengineering, Shock Physics, Mechanical Engineering, Civil & Environmental Engineering, Histopathology, Biology, Biochemistry and Aeronautics.

To date, the Centre has benefited from the engagement of a number of different organisations, including the Royal Centre for Defence Medicine (RCDM) the Defence Science and Technology Laboratory (Dstl) and a funded collaboration at the University of Cambridge.



## The Royal Centre for Defence Medicine

The Royal Centre for Defence Medicine in Birmingham has unrivalled experience in the clinical management of combat injury. Integral to RCDM's multidisciplinary approach to the management of these injuries is its ability to translate novel and emerging basic research findings into rigorous applied scientific advances in medical and surgical care. The volume of injury from recent and current conflicts managed by RCDM has enabled the development of powerful wound prediction and outcome tools that inform the clinical relevance of all basic research endeavours. CBIS works with RCDM on all clinical projects associated with serving medical officers.



## Defence Science and Technology Laboratory

The Defence Science and Technology Laboratory orchestrates the Science and Technology sector's response to the Ministry of Defence's current and future needs. Dstl interfaces with industry and academia to maximise the impact of S&T for defence and security requirements, and in doing so, delivers battle-winning technologies. Dstl project-manage a number of large defence contracts, often requiring the outsourcing of work to academic and industry expert partners. CBIS actively seeks to communicate the outputs of the work to Dstl and interact with Dstl collaboratively.



## University of Cambridge Collaboration

The Fracture and Shock Physics group in the Cavendish Laboratory and the Department of Veterinary Medicine, both located on the same site at the University of Cambridge, offer a unique working environment for part of the Centre's research activity. The proximity of these two world-class departments has fostered an expanding cross-disciplinary programme of research. A key development has been the adaption of experimental facilities, traditionally used to study hard materials and explosives, for the study of soft tissues susceptible to damage and infection in blast injuries. CBIS funds work at the University of Cambridge and supports researchers on infection research.

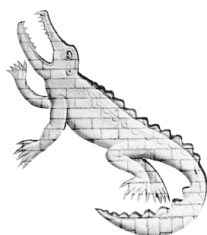

# Communication of the Work

## Media Focus

The Centre continues to generate media attention with visits, articles and interviews a regular occurrence. The following represents the external media reports for the year.

AnUBIS - Imperial College tackles IED Blast Injury (January 2012).

<http://www.youtube.com/watch?v=v7H8qx8QWP8> )

From Cells to Limbs. Physics Today (February 2012, Vol 65, Issue 2).

Reduce, redesign, repair. British Medical Association. (February 2012).

<http://bma.org.uk/news-views-analysis/news/2012/february/reduce-redesign-repair-the-medical-research-helping-injured-service-personnel>).

Discovery Channel. "Blast Lab" (November 2012).

The Bare Bones, Legion Magazine (April 2012).

<https://workspace.imperial.ac.uk/blastinjurystudies/Public/PETER5228.pdf>

AnUBIS – Giving Blast the Boot. Legion Magazine (July 2012).

Britische Elite – Unis bekommen Rustungs Millionen. Spiegel Online (3 September 2012).

Counter IED Report – Traumatic Injury Simulation (November 2012).

Radio 4 Interview with Anthony Bull and Richard Hollingham (2 May 2012).

Explosive look into world's leading IED blast lab. Defence IQ (September 2012).

<http://www.defenceiq.com/armoured-vehicles/articles/royal-navy-engineers/>).

The Centre's first Annual Network Event was held in September 2012. This event was deliberately aimed at internal networks and known collaborators with a nucleus of 60 close associates attending. This provided an excellent bedrock on which to build.

Our main face to the external world remains our website, which attracted over 12,000 page loads between March and December 2012. <http://www3.imperial.ac.uk/blastinjurystudies>.

## Invited Lectures

Bull AMJ. *An engineering analysis of injury due to IEDs – current conflicts and historical data*. IMechE Seminar 'Making the difference in force protection through mechanical engineering' (Bristol, UK). 6 Nov 2012.

Bull AMJ. *Blast injury*. NATO parliamentary subcommittee on energy and environmental security, Dec 2012.

Bull AMJ. *Ensuring better troop protection through fuller understanding of the physical impact of current AV attacks*. International Armoured Vehicles Conference, Farnborough, UK, Feb 2012.

Bull AMJ. *Sticks and stones may break my bones but blast does something different*. Andrew Little Lecture, Warwick University, UK. Mar 2012.

Bull AMJ. *CBIS Overview*. London Trauma Conference. (London, UK). 6 Dec 2012.

Clasper JC. *Traumatic amputations*. Aintree regional trauma meeting, Jun 2012.

Clasper JC. *Upper limb trauma on military operations*. Torquay lecture, Jun 2012.

Clasper JC. *Orthopaedic research*. Combined Services Orthopaedic Society meeting, May 2012.

Clasper JC. *DMS Research Methods*, NIHR Birmingham, Oct 2012.

Clasper JC. *Blasted Bones*, Citron Lecture, St George's Hospital, London, Dec 2012.

Masouros SD. *Modelling the load path from under-vehicle explosion to injury*. MSC.Software User's conference (Gaydon, UK). Sep 2012.

Newell N. *Gaining better understanding of injuries*. National Instruments Conference, Oct 2012.

Rankin S. *Armed forces welfare in the 21<sup>st</sup> century*. TRBL conference, 2012.

## Awards

Sir Philip Fulford Memorial Prize awarded to Maj JAG Singleton for the paper *Future unexpected survivors? Causes of death and injury patterns in explosive blast fatalities*. Combined Services Orthopaedic Society (CSOS) meeting, May 2012.

Best presentation prize awarded to S Masouros for the paper *Modelling the load path from under-vehicle explosion to injury*. MSC.Software UK-users' conference. Sep 2012.

Best poster prize. British Orthopaedic Foot and Ankle Society (BOFAS) annual meeting. Ramasamy A, Newell N, Masouros SD, Bonner TJ, West ATH, Hill AM, Clasper JC, Bull AMJ. *Design of a traumatic injury simulator for assessing lower limb response to high loading rates*. Nov 2012.

Rosetrees Essay Prize (2<sup>nd</sup>) – Royal College of Surgeons England. *Saving Private Tom: Preventing amputation from explosion*. Author: A. Ramasamy. Oct 2012.

The Founders Paper Best Paper was awarded to Maj N Walker for the paper *Infection after combat related limb trauma*. The Society of Military Orthopaedic Surgeons (SOMOS), Fort Lauderdale, Florida, USA. Nov 2012.

The Science Foundation of Ireland 2012 Student Award was awarded to N. Newell for the paper *Use of cadavers and anthropometric test devices (ATDs) for assessing lower limb injury outcome from under vehicle explosions*. International Research Council on the Biomechanics of Injury (IRCOBI) conference, Dublin, Ireland. Sep 2012.

Best podium presentation prize, runner up, awarded to Maj JAG Singleton for the paper *Blast mediated traumatic amputation: evidence for a new injury mechanism*. Fred Heatley Prize Meeting, Kings College Hospital, 28 November 2012.

Best clinical paper. British Trauma Society (BTS) annual meeting. Ramasamy A, Evans S, Kendrew JM, Cooper J. *The open blast pelvis: the significant burden of management*. May 2012.

## Recent Publications

List of documents produced by the Centre in 2012:

### Publications in peer-reviewed journals

Birch R, Misra P, Stewart MPM, Eardley WGP, Ramasamy A, Brown KV, Shenoy R, Anand P, Clasper JC, Dunn R, Etherington J. *Nerve injuries sustained during warfare. Part I: epidemiology*. The Journal of Bone and Joint Surgery – Br. 2012, 94-B(4): 523-528.

Birch R, Misra P, Stewart MPM, Eardley WGP, Ramasamy A, Brown KV, Shenoy R, Anand P, Clasper JC, Dunn R, Etherington J. *Nerve injuries sustained during warfare. Part II: outcomes*. The Journal of Bone and Joint Surgery – Br. 2012, 94-B(4): 529-535.

Brown KV, Guthrie HC, Ramasamy A, Kendrew JM, Clasper JC. *Modern military surgery: lessons from Iraq and Afghanistan*. The Journal of Bone and Joint Surgery – Br. 2012, 94-B(4): 543-543.

Breeze J, Allanson-Bailey LS, Hunt NC, Delaney RS, Hepper AE, Clasper JC. *Mortality and morbidity from combat neck injury*. The Journal of Trauma and Acute Care Surgery, 2012, 72(4): 969-974.

- Eardley WG, Watts SA, Clasper JC. *Extremity trauma, dressings, and wound infection. Should every acute limb wound have a silver lining?* The International Journal of Lower Extremity Wounds. 2012, 11(3): 201-212.
- Eardley WG, Watts SA, Clasper JC. *Limb wounding and antisepsis. Iodine and chlorhexidine in the early management of extremity injury.* The International Journal of Lower Extremity Wounds. 2012, 11(3): 213-223.
- Eardley WG, Martin KR, Talyor C, Kirkman E, Clasper JC, Watts SA. *The development of an experimental model of contaminated muscle injury in rabbits.* The International Journal of Lower Extremity Wounds. 2012, 11(4): 254-263.
- Eardley WG, Bonner TJ, Gibb IE, Clasper JC. *Spinal fractures in current military deployments.* The Journal of the Royal Army Medical Corps. 2012, 158(2): 101-105.
- Newell N, Masouros SD, Pullen AD, Bull AMJ. *The comparative behaviour of two combat boots under impact.* Injury Prevention. 2012, 18(2): 109-112.
- Masouros SD, Newell N, Ramasamy A, Bonner TJ, West ATJ, Hill AM, Clasper JC, Bull AMJ. *Design of a traumatic injury simulator for assessing lower limb response to high loading rates.* Annals of Biomedical Engineering. 2012, *in press*.
- Ramasamy A, Hill AM, Phillip R, Gibb IE, Bull AMJ, Clasper JC. *FASS is a better predictor of poor outcome in lower limb blast injury than AIS: implications for blast research.* Journal of Orthopaedic Trauma. 2012, *in press*.
- Ramasamy A, Evans S, Kendrew JM, Cooper J. *The open blast pelvis: the significant burden of management.* The Journal of Bone and Joint Surgery – Br. 2012, 94-B(6): 829-835.

## Government reports

IB/DSTL/0100112/01. Lower limb biomechanics testing.

## Presentations at conferences

### Government Experts on Mitigation Strategies (GEMS) Annual Meeting, Bristol, UK. Jan 2012.

- Newell N, Masouros SD, Bonner TJ, Ramasamy A, Clasper JC, Bull AMJ. *Assessing personal protection for underbelly vehicle explosion using anthropometric test devices (ATDs).*
- Masouros SD, Newell N, Bonner TJ, Ramasamy A, Clasper JC, Bull AMJ. *The response of the human leg in an underbelly vehicle explosion: a cadaveric study.*

### Combined Services Orthopaedic Society (CSOS) Annual Conference, Ash Vale, UK. May 2012.

- Bonner TJ, Singleton JAG, Masouros SD, Gibb IE, Kendrew JM, Clasper JC. *Knee dislocations in battlefield trauma.*
- Ramasamy A, Hill AM, Phillip R, Gibb IE, Bull AMJ, Clasper JC. *FASS is a better predictor of poor outcome in lower limb blast injury than AIS: implications for blast research.*
- Ramasamy A, Masouros SD, Newell N, Bonner TJ, West ATH, Hill AM, Clasper JC, Bull AMJ. *Design of a traumatic injury simulator for assessing lower limb response to high loading rates.*
- Singleton JAG, Gibb IE, Bull AMJ, Clasper JC. *Traumatic amputation from explosive blast: evidence for a new injury mechanism.*
- Singleton JAG, Gibb IE, Hunt N, Bull AMJ, Clasper JC. *Future unexpected survivors? Causes of death and injury patterns in explosive blast fatalities.*

Walker NM, Eardley W, Bonner TJ, Clasper JC. *UK combat related pelvic junctional vascular injuries 2008-2011: implications for future intervention.*

British Trauma Society (BTS) Annual Meeting. Leeds, UK. May 2012.

Evans S, Ramasamy A, Kendrew JM, Cooper J. *The open blast pelvis: the significant burden of management.*

Military Health Systems Research Symposium (MHSRS). Fort Lauderdale, Florida, USA. Aug 2012.

Singleton JAG, Gibb IE, Bull AMJ, Mahoney PF, Clasper JC. *External explosions causing in-vehicle blast lung injury in fatalities: new insights from post mortem CT analysis.*

Walker NM, Singleton JAG, Gibb IE, Bull AMJ, Clasper JC. *The epidemiology of traumatic amputations.*

10<sup>th</sup> international conference on the mechanical and physical behaviour of materials under dynamic loading (DYMAT). Freiburg, Germany. Sep 2012.

Bo C, Balzer J, Godfrey S, Francois M, Saffell JL, Rankin SM, Proud WG, Brown KA. *Pressure pulse induced-damage in live biological samples.*

British Orthopaedic Association (BOA) Annual Scientific Congress. Manchester, UK. Sep 2012.

Singleton JAG, Gibb IE, Hunt N, Bull AMJ, Clasper JC. *Future 'unexpected' survivors: causes of death and injury patterns in IED fatalities.*

Evans S, Ramasamy A, Kendrew JM, Cooper J. *The open blast pelvis: the significant burden of management.*

International Research Council on the Biomechanics of Injury (IRCOBI) 2012 Conference, Dublin, Ireland, Sep 2012.

Newell N, Masouros SD, Ramasamy A, Bonner TJ, Hill AM, Clasper JC, Bull AMJ. *Use of cadavers and anthropometric test devices (ATDs) for assessing lower limb injury outcome from under-vehicle explosions.*

Masouros SD, Newell N, Ramasamy A, Bonner TJ, Hill AM, Clasper JC, Bull AMJ. *A standing vehicle occupant is likely to sustain a more severe injury than one who has flexed knees in an under-vehicle explosion: a cadaveric study.*

National Agency for Finite Element Methods and Standards (NAFEMS) UK Conference, Belton, Lincolnshire, UK. Sep 2012.

Masouros SD, Newell N, Bull AMJ. *Modelling the load path from under-vehicle explosion to injury: FEA of a traumatic injury simulator, a combat boot and the lower limb.*

British Orthopaedic Foot & Ankle Society (BOFAS) Annual Meeting. Newport, UK. Nov 2012.

Ramasamy A. *Development of traumatic injury simulator for under-vehicle blast; outcomes from foot and ankle blast injuries.*

Society of Military Orthopaedic Surgeons (SOMOS) Annual Meeting. Naples, Florida, USA. Dec 2012.

Ramasamy A, Evans S, Kendrew JM, Cooper J. *The open blast pelvis: significant burden of management.*

Singleton JAG, Walker NM, Gibb IE, Bull AMJ, Clasper JC. *Could definitive through knee amputation be a viable option for lower extremity blast trauma casualties?*

Walker NM, McKinnon J, Green AD, Kendrew JM, Clasper JC. *Infection after combat-related limb trauma.*

## Education

The focus of the education programme is to ensure that the Centre is truly transdisciplinary. Engineers, scientists, and clinicians frequently have their own languages and systems of representing knowledge. The educational aim of the Centre is to facilitate the symbiotic transfer of information and understanding at the interfaces of the disciplines in order to produce studies and applications that could not be obtained within a discipline specific grouping. A further educational aim is to disseminate appropriately to stakeholders the workings of the Centre.

### [CBIS Research Days](#)

Every 4 months the Centre comes together for a day of research presentations focused around the work being carried out by the PhD students and Post-doctoral researchers. These days are fundamental in ensuring that the different disciplines come together and a common research language develops throughout the Centre. It is also a significant reminder of the common focus.

### [CBIS Annual Network Symposium](#)

This acts as a showcase for the research carried out in the Centre. Through invited speakers it also acts to signpost future research areas and collaboration opportunities.

### [CBIS Lecture Series](#)

Throughout the year internal and external speakers are invited to give lectures aimed at researchers, stakeholders and funding bodies. These provide opportunities to raise awareness of the research area as well as to provoke transdisciplinary discussion. All talks are open to the public as part of a wider engagement programme.

### [Postdoctoral Researchers \(PDRAs\)](#)

PDRAs are the backbone of the Centre. They bring knowledge and expertise from a diverse range of research fields. They play a vital role in driving research forward and taking responsibility in co-supervising the PhD and MD students and running the laboratories.

### [PhD Studentships.](#)

PhD students are the lifeblood of the Centre. They bring an influx of fresh ideas. The PhD programme is for 3 years, and each PhD student works towards a specific research priority area.

### [MD\(Res\) Studentships.](#)

The Centre's extensive links with the armed forces allows the Centre to run an MD programme (2 years) for serving military clinicians, alongside the PhD programme. The military clinicians are an asset to the grouping as they maintain the military focus and they provide access and analysis of the battlefield data necessary to form the right hypotheses and focus the research.

### [MRes, MSc, Undergraduate and Undergraduate Research Opportunity Programme Research Projects.](#)

Taught undergraduate and postgraduate students in College must complete an individual research project as part of their programme. The Centre offers a multitude of research projects every academic year.

**Imperial College**  
**London**



THE ROYAL BRITISH LEGION

**CENTRE FOR BLAST INJURY STUDIES**

AT IMPERIAL COLLEGE LONDON

