

A review of the AdS/CFT Duality

S. Nakach
September 20, 2013

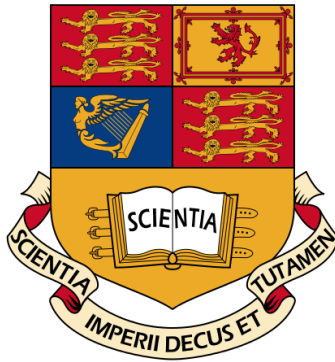

SUBMITTED IN PARTIAL FULFILMENT OF THE
REQUIREMENTS FOR THE DEGREE OF MASTER OF
SCIENCE OF IMPERIAL COLLEGE LONDON

Supervised by Professor Daniel Waldram

Abstract

We give a review of conformal and superconformal symmetry. We introduce $\mathcal{N} = 4$ Super Yang-Mills. We give a review of Type IIB Supergravity. We then state the correspondence between the two theories, and build a dictionary by matching symmetries, parameters and observables. We give some insight into further developments of the AdS/CFT correspondence

Contents

1	Introduction	3
2	Super Yang-Mills	5
2.1	Conformal Symmetry	5
2.1.1	CFT's and Wilsonian Renormalisation	5
2.1.2	A more in depth look at Conformal Symmetry	6
2.1.3	Representations, Primary Operators and unitarity bounds	8
2.1.4	Correlation functions	10
2.2	Supersymmetry	12
2.2.1	SUSY algebra	12
2.2.2	Massless Representations	12
2.2.3	Massive Representations	13
2.3	$\mathcal{N} = 4$ Super Yang-Mills	14
2.3.1	Lagrangian density and symmetries	14
2.3.2	Gauge invariant operators	16
2.4	Wilson Loops in Gauge theories	17
2.5	Diagrammatic expansion of matrix fields	21
3	Type IIB in AdS space	23
3.1	M-Theory and Type IIB	23
3.1.1	M-theory	24
3.1.2	Kaluza-Klein reduction and Type IIA	25
3.1.3	Type IIB	26
3.2	D-Brane Solutions	27
3.2.1	A prelude to introducing branes	27
3.2.2	Branes as solutions of SUGRA	28
3.2.3	A more stringy description of branes	30
3.2.4	Brane Worldvolume and symmetries	30
3.3	The D3 metric, and AdS Spacetime	32
3.3.1	Anti De-Sitter Space	32

4	The AdS/CFT Correspondence	35
4.1	The Decoupling Argument	35
4.2	Making The Correspondence Precise	38
4.2.1	Matching Parameters	38
4.2.2	Matching Symmetries	38
4.2.3	Matching Representations	39
4.2.4	Matching Correlation Functions.	42
4.2.5	Wilson Loops	48
5	Aspects of AdS/CFT and conclusion	54
5.1	Integrability	54
5.2	AdS/CMT	58
5.3	Concluding words	62
A	Conformal Algebra	65
B	Superconformal Algebra	66
C	Wilson loops in QED	67

Chapter 1

Introduction

The AdS/CFT correspondence is a surprising idea - at the stage of conjecture - brought up by Maldacena in 1998. It states that certain conformal field theories are dual ¹ to string theories living in higher dimensional Anti De-Sitter (AdS) backgrounds.

The idea that all the information contained in, say, a 10 dimensional theory is also contained in a 4 dimensional theory might seem outlandish. However for several examples there is a staggering amount of evidence supporting the correspondence, some of which we will outline in detail. First, we will simply state that this is an example of the holographic principle introduced first in 1993 by 't Hooft, and in 1994 by Susskind [48], [47].

The idea comes about when considering the Bekenstein bound on entropy. The latter arises when we consider matter, of mass M enclosed by a region of area A .

We assume that M is smaller than the mass of a black hole with area A , so that the region is just ordinary and not a black hole itself. Moreover, we assume that initially, the matter distribution is tenuous enough so that A encloses no black holes.

We then now consider a process which concentrates the matter inside A until it collapses and forms a black hole of mass M , and area A_{BH} .

We now call upon the generalised second law of thermodynamics introduced by Bekenstein which states that the total entropy of a system defined by $S_{total} = S_{matter} + S_{BH}$ cannot decrease, where S_{matter} is the usual entropy from thermodynamics [6]. In our scenario, all of the matter goes inside the black hole. This gives the inequality:

$$S_{matter} \leq S_{BH} \tag{1.1}$$

Furthermore, following Hawking, we know that $S_{BH} = A_{BH}/4$ [24] and by noting the initial assumptions, we see that $A_{BH} \leq A$. This leads to the

¹The nature of this duality will be explained more in depth later

Bekenstein entropy bound:

$$S_{matter} \leq A/4G_N \tag{1.2}$$

[8]. The fact that the maximum entropy inside a region scales with its surface area has deep consequences. Indeed if the physics inside it was described by a field theory excluding gravity, a quick calculation will seemingly contradict this result: to obtain the entropy inside the region, we need to estimate the number of different possible states in the Hilbert space of our theory. If we discretise the world into a lattice with spacing of the order of the Planck length, l_P and at each site put a spin chain with n degrees of freedom, we have n^V possible states (where V is given in units of l_P^3). Hence we estimate the entropy to be $S \sim V \ln(n)$.

This is in stark contradiction with the previous result. Starting here and following t'Hooft and Susskind, we come to the holographic principle. The idea is that a theory of quantum gravity in a volume can be described by some theory living on the volume's boundary, much like a two-dimensional film can project a three dimensional image in optics.

As we will see, following this principle, Maldacena's conjecture establishes a correspondence between a string theory - which is a quantum gravity theory - in the bulk of AdS space and a theory living on its boundary.

The canonical example - on which we will mainly focus in this report - is the correspondence between $\mathcal{N} = 4$ Super Yang Mills (SYM) theory and Type IIB string theory with N stacked D3 branes.

In this report, we will begin by introducing superconformal field theories in general, before learning about SYM, its symmetries, and its representations. We will then go on to talk about superstring theory - more specifically Type IIB - and its limit as a supergravity (SUGRA) theory and describe the AdS geometry. This will then lead us to stating the correspondence, and building a dictionary, mapping symmetries, representations and observables of both theories. Finally, we will touch on some of the more recent developments of the correspondence, and its links with other fields of physics.

Chapter 2

Super Yang-Mills

From the previous discussion, we can see that in order to begin understanding the AdS/CFT correspondence, it is crucial that we understand Super-Yang Mills theory in $d = 4$ dimensions. This theory contains a staggering amount of symmetry, which is why it is so special.

When looking at regular Quantum Field Theories, one might wonder what symmetries we might add on top of the usual Poincaré symmetry. There are several options. There is, first of all, what is known as conformal symmetry. This simply means that the theory is invariant under a shift in energy scales. Such symmetry arises in theories that have no scales such as the theory of a massless scalar for example. Another option, is to add Supersymmetry (SUSY), whose generators are fermionic, which relates fermions and bosons. We shall look at these in turn, before combining them in the example of $\mathcal{N} = 4$ Super Yang-Mills.

2.1 Conformal Symmetry

2.1.1 CFT's and Wilsonian Renormalisation

There are many reasons to study Conformal Field theories, even without considering the correspondence. Not least of which is that in Wilsonian renormalisation, field theories that live at fixed points are conformal field theories.

Trivially, every theory has a fixed point in the infrared (IR) and ultraviolet (UV) limit. Let's briefly study the example of a field theory containing a massless and a massive scalar in d spatial dimensions. The theory is defined from the Lagrangian density:

$$\mathcal{L} = \int d^d x (\partial\phi_1)^2 + m^2\phi_1^2 + (\partial\phi_2)^2 \quad (2.1)$$

It is easy to see, that in the UV limit, the mass of the field ϕ_1 becomes irrelevant, and can be ignored. The theory therefore flows towards a theory

with two massless scalar fields.

Similarly, in the IF, the massive field decouples out of the theory: the propagator of ϕ_1 goes as $\frac{1}{p^2+m^2}$, meaning that at energy scales which are much smaller than m , the propagator essentially vanishes and does not contribute to the theory. The flow then leads to a theory of a single massless scalar.

In both cases, we reach theories with no scale (since there is no mass). This is precisely the requirement stated above.

More interesting though, are interacting theories that have a non-trivial fixed point. At this point, the beta function vanishes as do the various scales present in the theory. The theory is then conformal and possesses additional symmetry, as we will see later on. This idea shows that CFT's are instrumental in understanding QFT's and RG flow in general. This alone would be a good reason to study them. There is, however, plenty more motivation.[50]

We also note that although our interest here lies in Field theories, Conformal invariance is of great importance in Statistical Mechanics. It occurs, for example in the Ising model, when systems are close to the critical temperature. There, physical quantities diverge as a power law with a critical exponent, and we observe scale invariance. It is important to note that the equivalent of critical exponents for us will be the “scaling dimensions”, which we shall denote Δ . They appear when we consider rescaling of the coordinate x in the following way:

$$\begin{aligned} x &\rightarrow x' = \lambda x \\ \Phi(x) &\rightarrow \Phi'(x') = \lambda^{-\Delta}\Phi(\lambda x) \end{aligned}$$

Where $\Phi(x)$ is some field with scaling dimension Δ [39]. This Δ will appear later.

2.1.2 A more in depth look at Conformal Symmetry

Conformal symmetry, in its most primal form, is simply the group of transformations that leave the metric invariant up to a local rescaling, ie.:

$$g_{\mu\nu}(x) \rightarrow \Omega(x)^2 g_{\mu\nu}(x) \tag{2.2}$$

A pragmatic way of defining a CFT, is from a generating functional. In the path integral formulation, the theory (in this case containing only scalars) can be described by:

$$W[g_{\mu\nu}, J] = \int \mathcal{D}\phi e^{-S[g_{\mu\nu}, J] + \int d^d x \sqrt{g} J(x) \mathcal{O}(x)} \tag{2.3}$$

where $S[g_{\mu\nu}, J]$ is the action, $g_{\mu\nu}$ is the background metric, g is its determinant, $J(x)$ is the “external field” and for now, $\mathcal{O}(x)$ is simply an operator.

Correlation functions are then obtained the usual way, by taking functional derivatives with respect to J and then setting it to 0:

$$\langle \mathcal{O}(x_1) \dots \mathcal{O}(x_n) \rangle = \frac{1}{\sqrt{g}} \frac{\delta}{\delta J(x_1)} \dots \frac{\delta}{\delta J(x_n)} W \Big|_{J=0} \quad (2.4)$$

What separates a CFT from a regular QFT is that it is invariant under a local Weyl transformation, ie. it obeys the following relation:

$$W[g_{\mu\nu(x)}, J(x)] = W[\Omega(x)^2 g_{\mu\nu(x)}, \Omega(x)^{d-\Delta} J(x)] \quad (2.5)$$

Where Δ is the conformal dimension of \mathcal{O} . Another useful way of expressing this statement is in terms of correlation functions:

if one defines the new coordinate \tilde{x}^μ such that: $d\tilde{x}^\mu d\tilde{x}_\mu = \Omega(x)^2 dx^\mu dx_\mu$, then correlation functions obey the following:

$$\langle \mathcal{O}_1(\tilde{x}_1) \dots \mathcal{O}_n(\tilde{x}_n) \rangle = \Omega(x_1)^{-\Delta_1} \dots \Omega(x_n)^{-\Delta_n} \langle \mathcal{O}_1(x_1) \dots \mathcal{O}_n(x_n) \rangle \quad (2.6)$$

Conformal symmetry has important implications on the correlation functions of the theory, but for now we focus on the requirement (2.2), which will give us the algebra of conformal transformations.

Let us consider infinitesimal coordinate transformations: $x^\mu \rightarrow x^\mu + \epsilon^\mu$.

The line element, $ds^2 = g_{\mu\nu} dx^\mu dx^\nu$, then transforms like:

$$ds^2 \rightarrow ds^2 + (\partial_\mu \epsilon_\nu + \partial_\nu \epsilon_\mu) dx^\mu dx^\nu \quad (2.7)$$

and in order to satisfy (2.2), we obtain the requirement that:

$$\partial_\mu \epsilon_\nu + \partial_\nu \epsilon_\mu = C g_{\mu\nu} \quad (2.8)$$

where C is some constant of proportionality. If we are in flat d -dimensional spacetime, $\mathbb{R}^{1,d-1}$, so that $g_{\mu\nu}$ is just the flat metric, $\eta_{\mu\nu}$, we can fix C by taking the trace of (2.8). We find:

$$\partial_\mu \epsilon_\nu + \partial_\nu \epsilon_\mu = \frac{2}{d} (\partial \cdot \epsilon) g_{\mu\nu} \quad (2.9)$$

A further constraint on ϵ can be obtained by contracting (2.9) with two derivatives:

$$(\eta_{\mu\nu} \partial^2 + (d-2) \partial_\mu \partial_\nu) \partial \cdot \epsilon = 0 \quad (2.10)$$

This last equation allows us to see that epsilon can at most be quadratic in x^μ , since three derivatives acting on it vanish. We can now give explicit forms for ϵ , the transformation parameter. From this we can also give the generators of the conformal algebra, and their action.

1. $\epsilon^\mu = a^\mu$. This is simply translations, generated by P^μ . Finitely, the transformation is:

$$x^\mu \rightarrow x^\mu + a^\mu.$$

2. $\epsilon^\mu = \omega^\mu{}_\nu x^\nu$ where ω is antisymmetric. Finitely, the transformation is:

$$x^\mu \rightarrow \Lambda^\mu{}_\nu x^\nu. \text{ Where } \Lambda \in SO(1, d-1).$$

This corresponds to Lorentz boosts and rotations, generated by $M_{\mu\nu}$. So far we have simply recovered the Poincaré algebra.

3. $\epsilon^\mu = \lambda x^\mu$. This corresponds to Dilations, generated by D . Finitely, the transformation is:

$$x^\mu \rightarrow \lambda x^\mu.$$

4. $\epsilon^\mu = b^\mu x^2 - 2x^\mu b \cdot x$. This corresponds to special conformal transformations, generated by K_μ . Finitely, the transformation is:

$$x^\mu \rightarrow \frac{x^\mu + b^\mu}{1 + 2b \cdot x + b^2}.$$

Note that this generator can also be expressed in terms of inversions, I , which act on x^μ as: $x^\mu \rightarrow \frac{x^\mu}{x^2}$, in the following way: $K^\mu = IP^\mu I$. [17]

The full conformal algebra is listed in appendix A.

2.1.3 Representations, Primary Operators and unitarity bounds

To classify the representations of a CFT, we use the eigenvalue of the Dilation operator D which is $-i\Delta$. Indeed, if $\mathcal{O}'(x)$ is an operator that has been infinitesimally dilated, and \mathcal{O} is normalised so that the two point function is of the form (2.25) (which we will see later) then,

$$\begin{aligned} \mathcal{O}'(0) - \mathcal{O}(0) &= (1 + \epsilon + \dots)^\Delta \mathcal{O}(0) - \mathcal{O}(0) \\ &= \Delta \epsilon \mathcal{O}(0) + \dots \end{aligned} \tag{2.11}$$

Which implies:

$$[D, \mathcal{O}] = -i\Delta \mathcal{O} \tag{2.12}$$

Now, if we consider a state $|\psi\rangle$ with dimension Δ , we can see from (A.5) and (2.12) that

$$\begin{aligned} DK^\mu |\psi\rangle &= ([D, K^\mu] + K^\mu D) |\psi\rangle \\ &= -i(\Delta - 1)K^\mu |\psi\rangle \end{aligned} \tag{2.13}$$

So we see that the generator K^μ lowers the dimension of the state. Similarly, (A.4) implies that P^μ raises it.

As per usual, we expect the spectrum to be bounded from below in physical theories, so there must exist some state $|\mathcal{O}\rangle$ such that $K^\mu|\mathcal{O}\rangle = 0$. These are known as primary operators. The spectrum of states is then built by acting P^μ 's on it, ie. by differentiating. Such states are known as descendants.

Furthermore, we note that given a correlator of primaries, we can always compute a correlator of descendants since:

$$\langle \partial_\mu \mathcal{O}(x_1) \mathcal{O}(x_2) \rangle = \frac{\partial}{\partial x_1^\mu} \langle \mathcal{O}(x_1) \mathcal{O}(x_2) \rangle \quad (2.14)$$

[50].

Imposing unitarity creates some interesting bounds. We will explicitly show this for the case where \mathcal{O} is a scalar. First, we begin by noting that $P^\dagger = K$. The strongest bound is obtained by imposing the following condition:

$$\|P_\mu P^\mu |\mathcal{O}\rangle\|^2 \geq 0 \quad (2.15)$$

and so:

$$\langle \mathcal{O} | K_\mu K^\mu P^\nu P_\nu | \mathcal{O} \rangle \geq 0 \quad (2.16)$$

$$(2.17)$$

We proceed by commuting operators using relations given in Appendix A. We remind that \mathcal{O} is primary, and also scalar, so that both K^μ and $M^{\mu\nu}$ acting on it give 0.

$$\langle \mathcal{O} | K_\mu K^\mu P^\nu P_\nu | \mathcal{O} \rangle = \langle \mathcal{O} | K_\mu ([K^\mu, P^\nu] + P^\nu K^\mu) P_\nu | \mathcal{O} \rangle \quad (2.18)$$

$$= \langle \mathcal{O} | K_\mu (2i(\eta^{\mu\nu} D + M^{\mu\nu}) + P^\nu K^\mu) P_\nu | \mathcal{O} \rangle \quad (2.19)$$

$$= 2\eta^{\mu\nu} \langle \mathcal{O} | (K_\mu P_\nu (1 + \Delta) + K_\mu (-\delta_\rho^\nu + 1) P_\nu + K_\mu P_\nu \Delta) | \mathcal{O} \rangle \quad (2.20)$$

$$= 2\eta^{\mu\nu} (2\Delta - (d - 2)) \langle \mathcal{O} | [K_\mu, P_\nu] | \mathcal{O} \rangle \quad (2.21)$$

$$= 8\Delta d \left(\Delta - \frac{d - 2}{2} \right) \geq 0 \quad (2.22)$$

So there are two possibilities: either $\Delta = 0$ which means \mathcal{O} is the trivial operator, or Δ satisfies the scalar unitary bound:

$$\Delta \geq \frac{d - 2}{2} \quad (2.23)$$

A similar bound can be obtained for operators of spin l [50] :

$$\Delta \geq d - 2 + l \quad (2.24)$$

2.1.4 Correlation functions

This symmetry places powerful constraint on the form of correlation functions. We give an Ansatz the form of the two point correlation function of an operator \mathcal{O} with conformal dimension Δ :

$$\langle \mathcal{O}(x)\mathcal{O}(y) \rangle = \frac{1}{(x-y)^{2\Delta}} \quad (2.25)$$

A fun exercise is then to verify that this satisfies (2.6). We shall do it, checking each symmetry in turn:

1) Translations. In this case, $\Omega(x) = 1$. Then,

$$\begin{aligned} \langle \mathcal{O}(x+a)\mathcal{O}(y+a) \rangle &= \frac{1}{(x+a-y-a)^{2\Delta}} \\ &= 1^{-\Delta} 1^{-\Delta} \langle \mathcal{O}(x)\mathcal{O}(y) \rangle \end{aligned} \quad (2.26)$$

indeed.

2) Lorentz transformations. Again, here,

$$ds^2 = \eta_{\mu\nu} dx^\mu dx^\nu \rightarrow \Lambda^\mu{}_\rho \Lambda^\nu{}_\sigma \eta_{\mu\nu} dx^\rho dx^\sigma = ds^2$$

so $\Omega(x) = 1$. Then,

$$\begin{aligned} \langle \mathcal{O}(\Lambda x)\mathcal{O}(\Lambda y) \rangle &= \frac{1}{(\Lambda^2(x-y)^2)^\Delta} \\ &= 1^{-\Delta} 1^{-\Delta} \langle \mathcal{O}(x)\mathcal{O}(y) \rangle \end{aligned} \quad (2.27)$$

Since $\Lambda^\mu{}_\rho \Lambda^\rho{}_\nu = \delta^\mu{}_\nu$.

3) Dilations. Here, $\Omega(x) = \lambda$ so,

$$\begin{aligned} \langle \mathcal{O}(\lambda x)\mathcal{O}(\lambda y) \rangle &= \frac{1}{\lambda^{2\Delta} (x-y)^{2\Delta}} \\ &= \lambda^{-\Delta} \lambda^{-\Delta} \langle \mathcal{O}(x)\mathcal{O}(y) \rangle \end{aligned} \quad (2.28)$$

as expected.

4) Special Conformal Transformations. In this case it is easier to show that the correlator is invariant under inversions. It then follows from earlier that it is invariant under special conformal transformations, since it is also invariant under translations. Also,

$$ds^2 = \eta_{\mu\nu} dx^\mu dx^\nu \rightarrow x^{-4} \eta_{\mu\nu} dx^\mu dx^\nu$$

so $\Omega(x) = x^{-2}$. Then,

$$\begin{aligned}\langle \mathcal{O}\left(\frac{x^\mu}{x^2}\right)\mathcal{O}\left(\frac{y^\mu}{y^2}\right)\rangle &= \frac{1}{\left(\frac{x^\mu}{x^2} - \frac{y^\mu}{y^2}\right)^{2\Delta}} \\ &= \left(\frac{x^2 y^2}{(x-y)^2}\right)^\Delta \\ &= (x^{-2})^{-\Delta}(y^{-2})^{-\Delta}\langle \mathcal{O}(x)\mathcal{O}(y)\rangle\end{aligned}\quad (2.29)$$

So this form indeed satisfies all of the conformal symmetries. More generally, for operators of \mathcal{O}_n^i of dimensions Δ_n , and where i are possible spin indices, we find the following:

2 point function. Since :

$$\langle \mathcal{O}_1^i(\tilde{x}_1)\mathcal{O}_2^j(\tilde{x}_2)\rangle = \Omega(x_1)^{-\Delta_1}\Omega^{-\Delta_2}(x_n)\langle \mathcal{O}_1^i(x_1)\dots\mathcal{O}_n^j(x_n)\rangle$$

and also, $\langle \mathcal{O}_1^i(x_1)\dots\mathcal{O}_2^j(x_2)\rangle = \langle \mathcal{O}_2^i(x_2)\dots\mathcal{O}_1^j(x_1)\rangle$, we know that the correlation vanishes, unless the conformal dimensions are the same. Following, [50] [17], we can always find a basis so that

$$G^{ij} = \langle \mathcal{O}_1^i(x_1)\mathcal{O}_2^j(x_2)\rangle = \frac{\delta^{ij}}{|x_1 - x_2|^{2\Delta}}\quad (2.30)$$

This is unique.

3 point function. If we define the distances $r_{ij} \equiv |x_i - x_j|$, then conformal symmetry again uniquely fixes the function as:

$$\begin{aligned}G^{ijk} &= \langle \mathcal{O}_1^i(x_1)\mathcal{O}_2^j(x_2)\mathcal{O}_3^k(x_3)\rangle \\ &= \frac{C^{ijk}}{r_{12}^{\Delta_1+\Delta_2-\Delta_3}r_{23}^{\Delta_2+\Delta_3-\Delta_1}r_{31}^{\Delta_3+\Delta_1-\Delta_2}}\end{aligned}\quad (2.31)$$

The reason the 2 and 3-point functions are fully fixed boils down to this: For 3 points or less, using conformal symmetry, we can always map them to 3 points of reference such as $x_1 = 0$, $x_1 = 1$, and $x_1 = \infty$. To do this, we can perform a translation so that the first point is at the origin, then use inversion to send it to infinity. Then we use rotation to align the two remaining points on the x_1 axis, and finally use translation and dilation to put them at 0 and 1.

4 point function. This time, the function isn't uniquely defined by symmetry! We can do the same procedure as above, but a 4th point, which we call z will remain. The 4 point function then takes the form:

$$\begin{aligned}G^{ijkl} &= \langle \mathcal{O}_1^i(x_1)\mathcal{O}_2^j(x_2)\mathcal{O}_3^k(x_3)\mathcal{O}_4^l(x_4)\rangle \\ &= f^{ijkl}(z, \bar{z}) \prod_{a<b} r_{ab}^{\Delta_a+\Delta_b-\Delta/3}\end{aligned}\quad (2.32)$$

Where $\Delta = \sum_{a=1}^4 \Delta_a$.

2.2 Supersymmetry

Supersymmetry (SUSY) is what we get when we add a fermionic symmetry (ie. one generated by anticommuting generators) in the theory. Here we will give a very brief introduction to SUSY in order to reach superconformal symmetries. For more details, see [52]. In what follows, we will assume that we are in 3+1 dimensions.

2.2.1 SUSY algebra

In what is called $\mathcal{N} = 1$ Supersymmetry, we add the Weyl spinor supercharges $\begin{cases} \mathcal{Q}_\alpha \\ \bar{\mathcal{Q}}_{\dot{\alpha}} \end{cases}$, where α is a spinor index. We will be interested in “Extended Supersymmetry” where there are \mathcal{N} supercharges. We now use \mathcal{Q}_α^a where $a = 1 \dots \mathcal{N}$. Together with Poincaré algebra, these form the Super-Poincaré algebra. Some of the algebra relations are instructive to think about:

$$\{\mathcal{Q}_\alpha^a, P_\mu\} = 0 \quad (2.33)$$

$$\{\mathcal{Q}_\alpha^a, \mathcal{Q}_{\dot{\beta}b}\} = 2\sigma_{\alpha\dot{\beta}}^\mu P_\mu \delta_b^a \quad (2.34)$$

$$\{\mathcal{Q}_\alpha^a, \mathcal{Q}_\beta^b\} = 2\epsilon_{\alpha\beta} \mathcal{Z}^{ab} \quad (2.35)$$

In the above, $\sigma_{\alpha\dot{\beta}}^\mu$ are Pauli matrices. \mathcal{Z}^{ab} are interesting objects called central charges. We can see from (2.35) that they must be antisymmetric (since the LHS is totally symmetric under exchange of \mathcal{Q} 's and on the RHS, ϵ is totally antisymmetric). Moreover, they have the property of commuting with every other generator in the theory.

This algebra has a $SU(\mathcal{N})$ symmetry which we call R-symmetry. This will be of importance later. [9]

2.2.2 Massless Representations

For massless particles, we can always find a frame such that $P^\mu = (E, 0, 0, E)$. In this frame,

$$\{\mathcal{Q}_\alpha^a, \mathcal{Q}_{\dot{\beta}b}\} = \begin{pmatrix} 4E & 0 \\ 0 & 0 \end{pmatrix}_{\alpha\dot{\beta}} \delta_b^a \quad (2.36)$$

From which it immediately follows that \mathcal{Q}_2^a vanishes, and hence, from (2.34) so do the central charges. We can then define a set of \mathcal{N} normalised creation

and annihilation operators: $a^a = \frac{\mathcal{Q}_1^a}{2\sqrt{E}}$ and $a^{\dagger b} = \frac{\bar{\mathcal{Q}}_1^a}{2\sqrt{E}}$. It also follows from the commutation relation of these operators with the angular momentum operators that a and a^\dagger lower and raise the helicity of the state respectively. We can therefore form a supermultiplet by starting from a lowest helicity state - which we denote $|\lambda\rangle$ and acting with all possible combinations of creation operators on it. The latter anticommute from (2.35) and the fact that there are no central charges. Hence, when building states, each creation operator can be used at most once. There are therefore ,

$$\sum_{i=0}^{\mathcal{N}} \binom{\mathcal{N}}{i} = \sum_{i=0}^{\mathcal{N}} \binom{\mathcal{N}}{i} 1^i = (1+1)^{\mathcal{N}}$$

so $2^{\mathcal{N}}$ different states. [44]

2.2.3 Massive Representations

For massive representations, things are not necessarily so simple. This time around, we go to the frame $P^\mu(M, 0, 0, 0)$ so that we get:

$$\{\mathcal{Q}_\alpha^a, \mathcal{Q}_{\dot{\beta}b}\} = \begin{pmatrix} 2M & 0 \\ 0 & 2M \end{pmatrix}_{\alpha\dot{\beta}} \delta_b^a \quad (2.37)$$

Here, the central charges are not necessarily zero. If they are, we follow the same procedure as above, with the difference that the \mathcal{Q}_2 supercharges are not zero. We therefore get twice as many creation/annihilation operators, for a total of $2^{2\mathcal{N}}$ states.

In the general case we need to work a little harder. First we note that for unitary representations, the RHS of (2.35) is positive definite. We therefore make use of the R symmetry to diagonalise it. What we obtain is

$$Z = \text{diag}(\epsilon Z_1, \dots, \epsilon Z_r)$$

where we say $\begin{cases} \mathcal{N} = 2r & \text{if } \mathcal{N} \text{ is even} \\ \mathcal{N} = 2r + 1 & \text{if } \mathcal{N} \text{ is odd} \end{cases}$

Moreover, if \mathcal{N} is odd, there will be an additional 0 as the last eigenvalue of Z .

We now split the a, b indices into $(w, R), (z, S)$ where $w, z = 1, 2$ and $R, S = 1 \dots r$ so that the first r indices correspond to $(1, R)$ and the others correspond to $(2, R)$. We can then redefine annihilation operators as:

$$a_\alpha^R = \frac{1}{\sqrt{2}} [\mathcal{Q}_\alpha^{1R} + \epsilon_{\alpha\beta} (\mathcal{Q}_\beta^{2R})^\dagger] \quad (2.38)$$

$$b_\alpha^R = \frac{1}{\sqrt{2}} [\mathcal{Q}_\alpha^{1R} - \epsilon_{\alpha\beta} (\mathcal{Q}_\beta^{2R})^\dagger] \quad (2.39)$$

and the creation operators are simply the transpose. These satisfy the usual relations of

$$\{a_\alpha^R, a_\beta^S\} = \{b_\alpha^R, b_\beta^S\} = \{a_\alpha^R, b_\beta^S\} = 0 \quad (2.40)$$

More interesting however, are the following anti-commutation relations:

$$\{a_\alpha^R, (a_\beta^S)^\dagger\} = \delta_{\alpha\beta} \delta^{RS} (2M + Z_S) \quad (2.41)$$

$$\{b_\alpha^R, (b_\beta^S)^\dagger\} = \delta_{\alpha\beta} \delta^{RS} (2M - Z_S) \quad (2.42)$$

Again, we use the unitarity argument to say that the LHS of (2.42) is positive definite. We then obtain the *BPS bound*:

$$2M \geq Z_R \quad (2.43)$$

We then see then see that if $Z_R < 2M$, $\forall R$ we have the same states as when the central charges vanish. However, if for certain values of R , $Z_R = 2M$, we say the BPS bound is saturated, and we get *multiplet shortening*. Indeed, for those values of R , the RHS of (2.42) vanishes, meaning some of the creation operators vanish. More precisely, for each eigenvalue that saturates the bound, the multiplet is shortened by half, so they will have a total of $2^{N-\hat{R}}$ states, where \hat{R} is the number of Z_R which saturate the bound. [29]

2.3 $\mathcal{N} = 4$ Super Yang-Mills

Now that we have the tools at our disposal, we will study the famous $\mathcal{N} = 4$ SYM, its representations and operators, as well as its symmetries. This is a theory which enjoys *superconformal invariance*, ie. the symmetry that arises when we combine the SUSY algebra with the conformal algebra.

2.3.1 Lagrangian density and symmetries

This is a gauge theory with, as its name suggests, 4 supersymmetries. To explain where its field content comes from, we first state that this theory does not contain gravity. Hence the maximum spin of the particles we expect is 1. We thus start with a gauge field, A^μ . By acting on it with supercharges, we get 4 different spin 1/2 particles, ie. 4 fermions λ_α^a where $a = 1 \dots 4$ and α is a spinor index. By acting 2 supercharges we get $\binom{4}{2} = 6$ scalars, X^i where $i = 1 \dots 6$. All these fields are in the adjoint representation of the gauge group, and a, i are indices of different representations of the R-symmetry group which is $SO(6)_R \sim SU(4)_R$. So we say that A^μ transforms in the trivial representation of the R-symmetry, while λ_α^a is in the **4**, and

X^i in the $\mathbf{6}$ of $SU(4)_R$. The Lagrangian density of the theory is completely determined by the supersymmetry, and is schematically [9]:

$$\begin{aligned} \mathcal{L} = \text{Tr} \left\{ -\frac{1}{g_{YM}^2} F_{\mu\nu} F^{\mu\nu} + \frac{\theta_i}{8\pi^2} F_{\mu\nu} \tilde{F}^{\mu\nu} - i\bar{\lambda}^a \not{D}\lambda_a - (D^\mu X^i)^2 + g_{YM} C_i^{ab} \lambda_a [X^i, \lambda_b] \right. \\ \left. + g_{YM} \bar{C}_i^{ab} \bar{\lambda}_a [X^i, \bar{\lambda}_b] + \frac{g_{YM}^2}{2} [X^i, X^j]^2 \right\} \end{aligned} \quad (2.44)$$

Where the trace is over the gauge group, C_I^{AB} and \bar{C}_I^{AB} are like Dirac matrices for the R-symmetry, and the two parameters are g_{YM} , the coupling, and θ_I , the instanton angle. The field strength $F_{\mu\nu}$ is given by $F_{\mu\nu} = \partial_\mu A_\nu - \partial_\nu A_\mu + g_{YM} [A_\mu, A_\nu]$ and $\tilde{F}_{\mu\nu} = \epsilon_{\mu\nu\rho\sigma} F^{\rho\sigma}$. This is manifestly Poincaré invariant and admits the following SUSY transformations:

$$\delta_X = [\mathcal{Q}_\alpha^a, X^i] = C^{iab} \lambda_{ab} \quad (2.45)$$

$$\delta_\lambda = \{\mathcal{Q}_\alpha^a, \lambda_{\beta b}\} = F_{\mu\nu} (\sigma^{\mu\nu})_{\alpha\beta} \delta_b^a + [X^i, X^j] \epsilon_{\alpha\beta} (C_{ij})_b^a \quad (2.46)$$

$$\delta_{\bar{\lambda}} = \{\mathcal{Q}_\alpha^a, \bar{\lambda}_\beta^a\} = C_i^{ab} \bar{\sigma}^\mu_{\alpha\beta} D_\mu X^i \quad (2.47)$$

$$\delta_A = [\mathcal{Q}_\alpha^a, A_\mu] = (\sigma_\mu)_\alpha^{\dot{\beta}} \bar{\lambda}_{\dot{\beta}}^a \quad (2.48)$$

One important consequence of SUSY in SYM is that the beta function actually vanishes. As a result, there is no energy scale associated with the theory. This is crucial as it means that on top of this, we can add conformal symmetry to the list. First, if we look at the potential term in (2.44) : $g_{YM}^2 [X^i, X^j]^2$, we see that it is positive definite. Thus the potential is necessarily minimised when $[X^i, X^j] = 0$. There are several possibilities to solve this, but we will be interested in the vacua that do not break gauge or spacetime symmetry, namely the condition that: $\langle X^i \rangle = 0$. In that case, there truly is no scale in (2.44). Indeed, looking at the (classical) dimensions of all operators, we get that the couplings, θ_I and g_{YM} are dimensionless [9].

Something interesting happens at this point. The conformal symmetry combines with SUSY to form superconformal symmetry. Of particular importance is the fact that the K^μ , the generators for special conformal transformations and the supercharges Q_α^a do not commute. Instead, in $d = 4$ they obey the following relation [49]:

$$[K^\mu, Q_\alpha^a] = \gamma^\mu S_\alpha^a \quad (2.49)$$

S_α^a , the ‘‘conformal supercharges’’ are a new set of fermionic generators, which will be of importance when looking at the representation of the symmetry group. More of the algebra is given in Appendix B.

The full conformal group for $\mathcal{N} = 4$ SYM is then $SO(2, 4) \sim SU(2, 2)$ and when we add the fermionic generators, we obtain the supergroup $SU(2, 2|4)$ [9]. The gauge and R-symmetry groups are in a direct product with the superconformal group.

There is one final, rather peculiar, symmetry that this theory enjoys. This comes about when considering the complex parameter τ :

$$\tau_{YM} \equiv \frac{\theta_I}{2\pi} + \frac{4\pi i}{g_{YM}^2} \quad (2.50)$$

The theory is then invariant under the $SL(2, \mathbb{Z})$ projection:

$$\tau_{YM} \rightarrow \frac{a\tau + b}{c\tau + d}, \text{ where } ad + bc = 1 \text{ and } a, b, c, d \in \mathbb{Z} \quad (2.51)$$

This is called Olive-Montonen duality, or S-duality [38]. It is instructive to note that in the case where the instanton angle vanishes, this duality can act as $g_{YM} \rightarrow 1/g_{YM}$ thus relating the strong and weak coupling regimes.

2.3.2 Gauge invariant operators

With the addition of some new generators, the landscape of different representations in superconformal theories is slightly different from that described in section 2.1.3. To get a flavour of what is going to happen, we first look at the dimensions of the different generators, which can easily be deduced from their action on the different fields:

$$\begin{aligned} [D] = [M_{\mu\nu}] = 0 & \quad , & [P^\mu] = 1 & \quad , & [Q_\alpha] = 1/2 \\ & & [K^\mu] = -1 & \quad , & [S_\alpha] = -1/2 \end{aligned} \quad (2.52)$$

From that, we conclude that applying the new conformal supercharge to a state will reduce its dimension. Since negative dimensions lead to non-renormalisability, it must be that we eventually reach a state which is annihilated by this S . This is known as a *superconformal primary operator* (SPO) or *Chiral primary operator*. Note that this is different from a conformal primary operator that is annihilated by K (although looking at (2.52) we can see that a SPO must also be a conformal primary operator). From there, every descendant state is constructed by applying P and Q to it. To recap, an SPO, \mathcal{O} , satisfies

$$[K, \mathcal{O}] = [S, \mathcal{O}] = 0 \quad (2.53)$$

and a look at appendix B will show us that we can never write \mathcal{O} as $[Q, \mathcal{O}']$ where \mathcal{O}' is some other operator since S and Q don't commute. We can therefore expect that SPO's aren't built out of anything appearing on the

RHS of equations (2.45) to (2.48). The only possibility left is that they are in fact composed of symmetrised combinations of the scalars. Since we will be interested in gauge invariant operators, we take the trace over the gauge group. If we are interested in the simplest forms of SPO's, ie. the ones that transform under irreducible representations of $SU(4)_R$, we get *single trace operators*:

$$\text{Tr}(X^{\{i_1 \dots i_n\}}) \quad (2.54)$$

where the brackets $\{\dots\}$ around the indices mean the part of the trace that is totally symmetric and traceless in the i_n indices.

Reducible representations of the R-symmetry group can then easily be obtained by multiplying single trace operators together.

We will see later that single trace operators are linked to single particle states while multiple trace operators are linked to bound states. [33]

Superconformal groups have another interesting feature for us. Representations of $SU(2, 2|4)$ can be labelled by their quantum numbers under the bosonic subgroup, $SO(1, 3) \times SO(1, 1) \times SU(4)_R$. It turns out that for unitary representations, these quantum numbers are related. In particular, Δ , the $SO(1, 1)$ quantum number is bounded by below from the other numbers. To get these bounds, we recall that primary operators have the smallest Δ eigenvalue, and zero $SO(1, 3)$ numbers. Following [15] and references therein, we find that there are several possibilities, which are conveniently listed in [9].

To summarize these, there are two classes of multiplets. First of all, there are “long multiplets” also called “non-chiral” or “non- BPS”, which are multiplets for which none of the supercharges, \mathcal{Q} commute with the primaries. For these, the unitarity merely implies a lower bound on Δ . The second class are “Chiral multiplets” or “BPS multiplets” where some of the supercharges commute with the primaries. For these, the dimensions are directly related to the highest weights of the R-symmetry representation. A given operator, \mathcal{O} will be in a specific representation of $SU(4)_R$, and this is a constant. This implies that operators in chiral multiplets have cannot receive quantum corrections to their dimensions, they are protected!

2.4 Wilson Loops in Gauge theories

Another interesting observable of gauge theories that we will study in this review are Wilson loops. The Wilson loop operator is defined as follows:

$$W(\mathcal{C}) \equiv \text{Tr} \mathcal{P} e^{\oint_{\mathcal{C}} A} \quad (2.55)$$

Where \mathcal{C} denotes the path contour, \mathcal{P} is the path ordering operator. That is to say, the above exponential can be expanded as:

$$\begin{aligned}
 W(\mathcal{C}) \equiv Tr & \left[1 + i \int_0^T dt A_\mu(x(t)) \dot{x}^\mu(t) \right. \\
 & - \int_0^T dt_1 \int_0^{t_1} dt_2 A_{\mu_1}(x(t_1)) \dot{x}^{\mu_1}(t_1) A_{\mu_2}(x(t_2)) \dot{x}^{\mu_2}(t_2) \\
 & \left. + \dots \right] \tag{2.56}
 \end{aligned}$$

Where the action of the \mathcal{P} is to make sure that the integrals are made in order, instead of being independent of each other.

As long as the contour is closed, this is gauge invariant, and has a physical interpretation. It is associated with the propagation of a particle, such as a quark for instance in the presence of a gauge field. Furthermore, since the contour is fixed so we may only consider infinitely massive whose trajectories will not be subject to perturbations.

An interesting exercise is to consider a heavy quark and anti quark which are moving parallel to each other. We expect to recover the Coulomb potential, ie. a behaviour like $V \sim 1/r$. We will breeze through this calculation, in order to get a feel for the use of Wilson loops in gauge theories. For now, we will only consider the $U(1)$ electric force between the two. To compute the potential, we use the $W(\mathcal{C})$ operator in the following way: we consider the rectangular contour showed in figure 2.1 where T is the temporal direction, and L the spatial distance between the two. We will then take $T \rightarrow \infty$. The

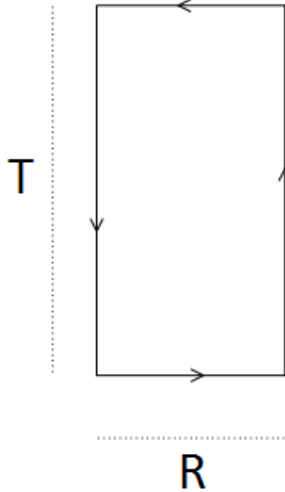

Figure 2.1: Rectangular loop used to compute the Coulomb potential between a quark and an antiquark. [31]

operator is then linked to the potential, V , in the following way:

$$\langle W(\mathcal{C}) \rangle \propto e^{-TV(L)} \quad (2.57)$$

The theory that we consider is simply pure Maxwell theory:

$$S = \int d^d x F^{\mu\nu} F_{\mu\nu} \quad (2.58)$$

In order to compute the LHS, we use the definition (2.56). We then perform the usual Wick contractions. A contraction between two A 's will give a propagator, $D_{\mu\nu}$. The latter, is (in Euclidean space and in the Feynman gauge):

$$D_{\mu\nu}(x-y) = \frac{\delta_{\mu\nu}}{(4\pi^2)(x-y)^2} \quad (2.59)$$

We also recall that $\langle A \rangle = 0$ to notice that only even terms will survive. The LHS of (2.56) can then be expressed in terms of a sum of Feynman diagrams. Furthermore, what we are really computing is

$$V(L) \propto - \lim_{T \rightarrow \infty} \frac{1}{T} \ln \langle W(\mathcal{C}) \rangle \quad (2.60)$$

So we should only look at connected diagrams. Finally, we note that this theory contains only photons which don't interact (the quarks can interact with the photons, but are otherwise external to the theory). There are therefore no interacting diagrams. We follow [50], and find that there are 5 possible diagrams, shown in 2.2. Out of those diagrams, (b) will tend to 0 as $T \rightarrow \infty$ since it goes as $\sim \int_0^T \frac{dt}{t^2} = 1/T$. Diagram (c) is 0 outright, since it involves a product of two perpendicular vectors $\dot{x}(t_1)^\mu \cdot \dot{x}(t_2)^\nu$. Finally, diagram (e) will not involve \mathbb{T} , and thus will become irrelevant because of the factor of $1/T$ in (2.60).

We are then left to calculate (a) and (c). The latter actually gives a divergence which can be absorbed by a renormalisation scheme (its contribution gives a correction corresponding to the Lamb shift). We will thus simply focus on (a). To simplify the calculation, we choose a parametrisation such that $\dot{x}(t_1) = \dot{x}(t_2) = 1$. We then have to compute the following:

$$\text{diagram(a)} = \frac{e^2}{4\pi^2} \int_0^T dt_1 \int_0^T dt_2 \frac{1}{R^2 + (t_2 - t_1)^2} \quad (2.61)$$

Note that we have included a factor of e^2 that simply comes from the two interaction points between the quarks and the photon. The integral is done in appendix C. The result is:

$$\text{diag(a)} = \frac{2T}{R} \arctan\left(\frac{T}{R}\right) - \log\left(\frac{T^2}{R^2} + 1\right) \quad (2.62)$$

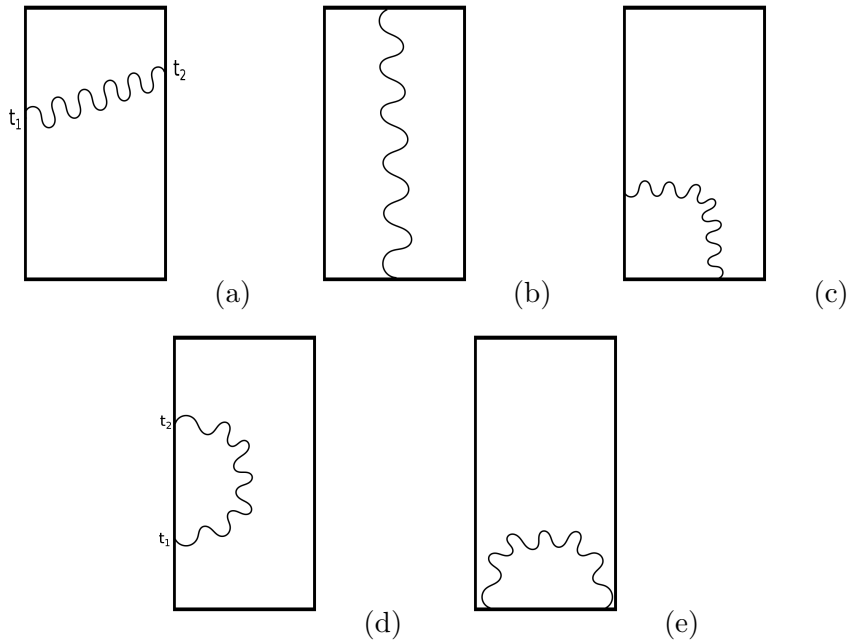

Figure 2.2: Diagrams contributing to the potential

So we see that in the limit of $T \gg 1$ we get:

$$\text{diag(a)} \sim \frac{e^2}{4\pi^2} \left[\frac{\pi T}{R} - \log\left(\frac{T^2}{R^2}\right) \right] \quad (2.63)$$

Where we used the fact that $\lim_{x \rightarrow \infty} \arctan x = \pi/2$.

When plugging this in (2.60), only the first term will survive, and we get :

$$V(R) = \frac{e^2}{4\pi R} \quad (2.64)$$

Which is Coulomb's law!

After this minor triumph, we could get bold and decide to move on to non-abelian gauge theories such as our beloved $\mathcal{N} = 4$ SYM. However, one can quickly see that this will lead to many more diagrams: the gluons will interact with each other, and we will need to include an infinite number of loop diagrams to be precise. This will be simpler when we consider Wilson loops in the AdS/CFT correspondence. [50] ,[31].

2.5 Diagrammatic expansion of matrix fields

While we are still discussing the gauge side of the correspondence, it is worth having a look at the perturbative expansion of matrix field theories. By this, we do not mean 2-dimensional matrix models, but interacting theories where the fields can be represented as matrices contracted with each other. This is exactly the case for our SYM, as the fields are in the adjoint representation of $SU(N)$, and terms in the lagrangian are traced over. For our purposes, we will use a simpler model, where we only consider scalars, Φ and the indices $a, b \dots$ are gauge group indices. The lagrangian we will consider is a (very) simplified version of the SYM lagrangian:

$$\mathcal{L} = \frac{1}{g^2} \text{Tr}((\partial\Phi)^2 + \Phi^2 + \Phi^3) \quad (2.65)$$

Now, by inverting the kinetic term we can get the propagator. Schematically, it is easy to see what we should get:

$$\langle \Phi_b^a \Phi_c^d \rangle \propto g^2 \delta_c^a \delta_b^d \quad (2.66)$$

We can represent this using oriented lines as per usual with a Feynman diagram, as seen in Figure 2.3.



Figure 2.3: Propagator diagram defined by (2.66).

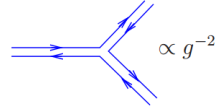

Figure 2.4: 3-Point vertex.

Moreover, we will write vertices as shown in figure 2.4. Note that these will be proportional to g^{-2} as it is the coefficient of the Φ^3 term. Another feature of this model is that for every loop of the diagram, we will obtain a factor of $\delta_a^a = N$.

It is now useful to define the parameter $\lambda \equiv g^2 N$ and express the diagram's contribution in terms of it. We then denote E the number of propagators in a diagram which is also the number of edges, V the number of vertices and F the number of loops, which is also the number of faces. Then, any given diagram contributes as:

$$\text{diagram} \sim \left(\frac{\lambda}{N}\right)^E \left(\frac{N}{\lambda}\right)^V N^F = \lambda^{E-V} N^{V+F-E} \quad (2.67)$$

What we notice is that the exponent of N is none other than the Euler characteristic: $\chi = 2 - 2g$, where g is the genus of the surface. The result is that we have planar diagrams which always contribute with powers of N^2 ,

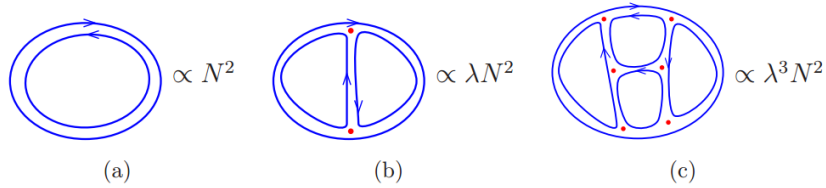

Figure 2.5: Several planar diagrams contributing to the vacuum polarization.

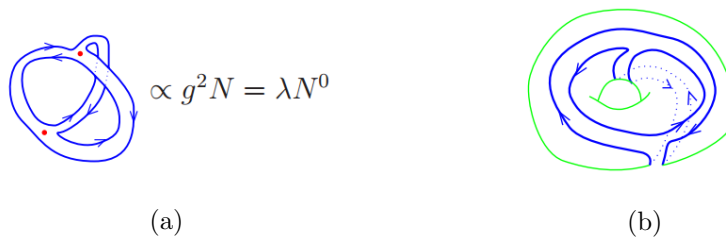

Figure 2.6: A non planar diagram. Figure 2.6b shows the diagram drawn on a torus with genus 1.

as on figure 2.5 As well as non-planar diagrams which contribute with less powers of N (eg diagrams on a torus contribute with N^0 , see figure 2.6).

As explained in [1], this analysis also works for correlation functions of the form

$$\left\langle \prod_{i=1}^n G_i \right\rangle$$

where G_i is made of single trace operators. A fact which will be of importance later is that when we take the limit where $N \gg 1$ we see that non-planar diagrams contribute negligibly, and the theory can be fully described in terms of planar diagram.[33] [50]

Chapter 3

Type IIB in AdS space

We will now focus on the other side of the correspondence - the AdS in AdS/CFT. This involves some understanding of string theory, although we will try to avoid delving too far into its depths. Instead we will focus on explaining just enough machinery needed to set up the brane picture that will be of relevance to us.

At its core, string theory is the idea that fundamentally, the universe isn't composed of particles following a 1 dimensional worldline, but extended objects, strings and even branes whose evolution in spacetime forms a worldsheet. In the beginning, this idea was developed in the hope of explaining QCD, but it was soon replaced by gauge theories (which makes it very interesting and exciting that we later discovered a correspondence between the two). This was not the end of String Theory, however and it now contains the best hopes for a quantum theory of gravity. Indeed, the particle that mediates gravity, the graviton, would have to couple to the stress energy Tensor, and thus be a spin 2 particle. The problem is that such a field is decidedly non-renormalisable in regular QFTs [54]. The same is not true in a string theory description, and so we can have a consistent quantum theory of gravity.

In the correspondence, this gravity theory will live in the bulk of the spacetime, while the CFT will live on the boundary.

3.1 M-Theory and Type IIB

In String Theory, there exists restrictions which mean that it cannot be consistent in any number of dimensions. We will be specifically interested in superstring theory and its classical limit supergravity (SUGRA), so we will take Supersymmetry for granted. With this premise, one of the most natural settings for superstring theory is *M-Theory*, in $d = 11$ dimensions. This comes about with the following considerations: there exist arguments stating that there cannot be massless particles with spin higher than two in

consistent theories. This is shown for example in [43] by generalising the Weinberg Witten theorem which states that one cannot have fields massless of spin higher than 1 that couple to Poincaré conserved charges [51]. Consequently, the range of helicities in the massless multiplet we consider is 4. This necessitates 8 creation operators, meaning 16 operators in total. Together with the result from 2.2.2 we expect 32 supercharges at most. This puts restrictions on the allowed number of supersymmetry for a given dimension. Indeed, we need to satisfy

$$\mathcal{N} \dim(S_d) \leq 32 \quad (3.1)$$

where $\dim(S_d)$ is the dimension of the (Weyl/Majorana) spinor representation in d dimension. The latter can be found in appendix B of [42]. There, we can see that the maximum number of dimensions possible is then $d = 11$ with $\mathcal{N} = 1$ (note that $d = 4$ and $\mathcal{N} = 4$ conveniently saturate the bound as well). This theory is unique in supergravity and called M-Theory.

3.1.1 M-theory

Here, we briefly introduce M-theory by stating its particle content and its action.

The massless particles in d dimensions will be representations of the little group of the full $SO(d-1, 1)$ algebra. This is the group that leave massless states invariant. By going to the frame where $P^\mu = (E, 0, \dots, E)$, it is easy to see that the little group will be $SO(d-2)$ (so $SO(9)$ for M-theory). We then begin by looking for a graviton $g_{\mu\nu}$, which will be in the second symmetric traceless representation. It therefore has: $\frac{(d-2)(d-1)}{2} - 1$ bosonic degrees of freedom, so 44 in our case. The next particle to follow is the gravitino, $\psi_{\alpha\mu}$, of spin 3/2, which has

$$(d-3)2^{\frac{d-3}{2}} \quad (3.2)$$

degrees of freedom, so $8 \cdot 16 = 128$ here. However, since the theory is supersymmetric, we must have equal number of fermionic and bosonic degrees of freedom, so we are missing 84 in the bosonic sector. This is exactly the dimension of the 3rd antisymmetric representation of our little group, so the last field is a 3-form $C_{\mu\nu\rho}^{(3)}$. For future reference, note that a p -form has $\binom{d-2}{p}$ degrees of freedom. [21]

This theory is populated by few fields, and it is described by an unusually simple action. The bosonic part is:

$$S_{11} = \frac{1}{2\kappa_{11}^2} \int d^{11}x \sqrt{-g} (R - \frac{1}{2}|F_4|^2) - \frac{1}{6} \int C_3 \wedge F_4 \wedge F_4 \quad (3.3)$$

Where κ_{11} is related to the 11-dimensional Newton's constant, R is the Ricci scalar of the background metric, $C_3 = C_{\mu\nu\rho}^{(3)} dx^\mu dx^\nu dx^\rho$ and $F_4 = dC_3$. This action is unique and constrained by Super-Poincaré invariance as well as gauge invariance of the 3-form: $C_3 \rightarrow C_3 + d\Lambda_2$ where Λ_2 is some 2-form. [2]

3.1.2 Kaluza-Klein reduction and Type IIA

The theory that concerns us, namely type IIB, is actually 10-dimensional. we can get an insight on how to obtain it by dimensionally reducing M-theory on a circle to obtain type IIA. By looking at how the massless particle content can be factorised into a tensor product, we will get a hint on how to obtain Type IIB. Note that we preserve the same amount of supercharges, 32, and so Type II theories have an $\mathcal{N} = 2$ supersymmetry as a result.

In order to obtain the field content of Type II A, we compactify one of the dimensions on a circle of radius R . That is to say, if our theory lives in a d-dimensional spacetime M^d we go to $M^{d-1} \times S^1_R$. We then look at the limit of $R \rightarrow 0$ to get dimensional reduction. One way to see what happens to the fields when we do that is to look at how the equations of motion are affected. For instance, for scalar fields, we need to look at what happens to the d-dimensional Laplacian as well as the field itself. This is relatively simple to do for this case and explained in section 4.3 of [9]. The upshot is that compactifying dimensions gives Kaluza-Klein modes which decouple out of the theory in the dimensional reduction limit. A more efficient way of saying this is that we obtain the representations for the branching rules of the little group, $SO(8) \subset SO(9)$. Hence, a scalar gives a scalar for example. Using highest weight notation, the branching rules for our case are:

$$[2, 0, 0, 0]_9 \rightarrow [2, 0, 0, 0]_8 + [1, 0, 0, 0]_8 + [0, 0, 0, 0]_8$$

$$g_{MN} \qquad g_{\mu\nu} \qquad A_\mu \qquad \Phi$$

$$[0, 0, 1, 0]_9 \rightarrow [0, 1, 0, 0]_8 + [0, 0, 1, 1]_8$$

$$C_{MNP}^{(3)} \qquad B_{\mu\nu} \qquad C_{\mu\nu\rho}^{(3)}$$

$$[1, 0, 0, 1]_9 \rightarrow [1, 0, 0, 1]_8 + [1, 0, 1, 0]_8 + [0, 0, 0, 1]_8 + [0, 0, 1, 0]_8$$

$$\psi_{AM} \qquad \psi_{\alpha\mu}^+ \qquad \psi_{\alpha\mu}^- \qquad \lambda_\alpha^+ \qquad \lambda_\alpha^-$$

Where MN and $\mu\nu$ are spacetime indices in 11 and 10 dimensions respectively while A and α are spinor indices. We see that the zoology of type IIA is more diverse. We still have a graviton, a 3-form, but we also have a scalar, Φ called dilaton, a gauge field A_μ , a 2-form $B_{\mu\nu}$, gravitini of opposite

chiralities $\psi_\alpha^{\pm\mu}$ and spinors of opposite chiralities, λ_α^\pm . It is interesting that we can factorise all of these in terms of “vector multiplets”:

$$([1, 0, 0, 0]_8 + [0, 0, 0, 1]_8)([1, 0, 0, 0]_8 + [0, 0, 1, 0]_8) \quad (3.4)$$

3.1.3 Type IIB

From the above, one could ask what happens if we factorise the vector multiplets in the following way:

$$([1, 0, 0, 0]_8 + [0, 0, 0, 1]_8)^2 \quad (3.5)$$

The result is the particle content of Type IIB SUGRA:

$$\begin{aligned} [1, 0, 0, 0]^2 &= [2, 0, 0, 0] + [0, 1, 0, 0] + [0, 0, 0, 0] \\ &\qquad\qquad\qquad g_{\mu\nu} \qquad\qquad B_{\mu\nu} \qquad\qquad \Phi \\ [1, 0, 0, 0] \otimes [0, 0, 0, 1] &= [1, 0, 0, 1] + [0, 0, 1, 0] \\ &\qquad\qquad\qquad \psi_{\alpha\mu}^{1,2} \qquad\qquad \lambda_\alpha^{1,2} \\ [0, 0, 0, 1]^2 &= [0, 0, 0, 2] + [0, 1, 0, 0] + [0, 0, 0, 0] \\ &\qquad\qquad\qquad A_{\mu\nu\rho\sigma}^{(4)+} \qquad C_{\mu\nu}^{(2)} \qquad C^{(0)} \end{aligned}$$

As expected from the form of the factorisation, some of the content is shared with type IIA, while there are new fields. In particular, we have a new scalar, the axion C , another 2-form, $C_{\mu\nu}^{(2)}$, and a 4-form, $C_{\mu\nu\rho\sigma}^{(4)+}$. The + in the exponent stands for the fact that in 10 dimensions, its field strength is self-dual. Moreover, we note that the fermionic content in type IIB is of the same chirality. Writing down an action for Type IIB actually turns out to be challenging at first sight because of $C_{\mu\nu\rho\sigma}^{(4)+}$. Indeed we have to impose the self duality condition artificially afterwards (it doesn’t come automatically from the equations of motion). First, we write the various p-forms as, for example:

$$B_2 = \frac{1}{2!} B_{\mu\nu}^{(2)} dx^\mu dx^\nu \quad (3.6)$$

and then define the field strengths

$$F_1 = dC \quad (3.7)$$

$$H_3 = dB_2 \quad (3.8)$$

$$F_3 = dC_2 \quad (3.9)$$

$$F_5 = dA_4^+ \quad (3.10)$$

and the two combinations :

$$\tilde{F}_3 = F_3 - CH_3 \quad (3.11)$$

$$\tilde{F}_5 = F_5 - \frac{1}{2}A_2 \wedge H_3 - \frac{1}{2}B_2 \wedge H_3 \quad (3.12)$$

Finally, the bosonic part of the action is [9] :

$$S_{IIB} = \frac{1}{4\kappa_B^2} \int \sqrt{-g} e^{-2\Phi} (2R + 8\partial_\mu \Phi \partial^\mu \Phi - |H_3|^2) - \frac{1}{4\kappa_B^2} \int [\sqrt{-g} (|F_1|^2 + |\tilde{F}_3|^2 + \frac{1}{2}|\tilde{F}_5|^2) + A_4^+ \wedge H_3 \wedge F_3] \quad (3.13)$$

So far we have only considered supergravity, not superstring theory. This is done in an attempt to stray away from the complexity of fully blown string theory, and we justify it by the fact that for Type IIB, the supergravity action is a low energy effective action for string theory. Indeed, in string theory actions, there is an overall factor of $\sim \frac{1}{\alpha'}$ where $\alpha' \equiv l_s^2$ and l_s^2 is the length scale for strings. In the limit where $\alpha' \rightarrow 0$ we get that massive terms acquire an infinite mass and decouple out of the full string theory, leaving us with only the massless modes we observe in supergravity. Conceptually this makes sense: as we zoom out to a scale where strings are effectively point-like particles, stringy effects should become irrelevant. [42], [2]

3.2 D-Brane Solutions

In modern string theory, we often consider objects called *branes*. These are extended supersymmetric objects propagating in a given number of dimensions of the full background. A quick picture can be obtained by considering the following:

- Particles evolving in time trace out a *worldline*.
- Strings evolving in spacetime trace out a *worldsheet*.
- Branes evolving in spacetime trace out a *worldvolume*.

3.2.1 A prelude to introducing branes

At this point, it is appropriate to remind the reader of a short story from a long time ago - namely electromagnetism.

We (probably) live in a 4 spacetime dimensions. Electric fields are generated by particles which propagate in 0 spatial directions. We understand this force as originating from a gauge field A (which is also a 1-form technically) that couples to these zero dimensional objects. Formally, the way to see this

is that we build a gauge invariant 2-form field strength from the gauge field: $F = dA$. We then proceed to integrate over this field strength. To obtain a scalar quantity, we must integrate over a two dimensional surface. The important point is that two-dimensional surfaces encompass 0 dimensional objects. We therefore get Gauss' law :

$$\oint E \cdot dS = Q/\epsilon_0 \quad (3.14)$$

which tells us that the point particle is a source for this electric field (we remind that the electric field simply represents some of the components of the field strength).

In general, in d spacetime dimensions a $p + 1$ -dimensional surface will encompass an object propagating in $d - 1 - (p + 1) = d - p - 2$ spacetime dimensions.

3.2.2 Branes as solutions of SUGRA

We now take the kindergarten example above it, and promote it to a middle school problem. We go back to our Type II setting. One can ask what happens when we turn on some of the p-forms we obtained. Exactly the same thing!

We take a p-form, and build a $p + 1$ field strength, we then integrate over it with a $p + 1$ dimensional surface. As a result, we get objects extending in $d - p - 2$ dimensions, which we call branes. The interpretation is that these branes are electrically charged under these p-forms. For example, the field A_4^+ couples to objects extending in $10 - 4 - 2 = 4$ dimensions which we call D3 branes. The D stands for Dirichlet, which will be explained later, while 3 stands for 3 spatial dimensions.

Poincaré duality plays an important role in this picture. Given a $p+1$ field strength F_{p+1} , it has an associated magnetic dual:

$$F_{d-p-1}^{mag} = *F_{p+1} \quad (3.15)$$

which magnetically couples to a $d - 1 - (d - p - 1) = p$ dimensional object. Taking the case of A_4^+ again, we get a D3 brane once more. Indeed, this form is self-dual in 10 dimensions. For a more complete review of D-branes, see the lectures [41].

Solving the type IIB equations of motion is very much akin to solving Einstein's equations (ie. rather hard). If one assumes a certain amount of symmetry, we arrive to brane solutions. For Dp branes, what happens is the following: a Dp brane separates spacetime into longitudinal and transverse

directions. We denote them as :

$$\begin{aligned} x^\mu & \quad \mu = 0, \dots, p && \text{are coordinates along the brane,} \\ y^u = x^{p+u} & \quad u = 1, \dots, d - (p + 1) && \text{are coordinates transverse to the brane.} \end{aligned}$$

We then look for solutions that preserve Poincaré symmetry along the x^μ directions (and so must be a rescaling of the minkowski metric), and spherical symmetry along the transvers symmetry (and so must be a rescaling of the Euclidean metric). In other words, a D brane has $\mathbb{R}^{p+1} \times SO(1, p) \times SO(9 - p)$ symmetry.

Turning on the different p-form fields, we obtain different solutions, of the following form:

$$ds^2 = H(y)^{-1/2} dx^\mu dx_\mu + H(y)^{1/2} dy^2 \quad (3.16)$$

$$e^\Phi = H(y)^{\frac{3-p}{4}} \quad (3.17)$$

In the above, $H(y)$ is a Harmonic function which takes the form :

$$H(y) = 1 + \frac{L^{d-p-3}}{y^{d-p-3}} \quad (3.18)$$

L is a scale factor, and is a function the parameter α' since it is the only dimensionful parameter in the theory.

We now specialise to the case of N parallel, coinciding D3 branes in order to proceed towards building up our picture for the correspondence. In this case, both the dilaton and axion fields are constant, B_2 and A_2 vanish, and we have:

$$F_{\mu\nu\rho\sigma\tau}^{(5)+} = \epsilon_{\mu\nu\rho\sigma\tau u} \partial^u H(y) \quad (3.19)$$

Moreover, the form of the metric is similar to (3.16) for $p = 3$ but generalised for several branes. If we switch to spherical coordinates for the transverse directions, r being the radial coordinate, it is [28] :

$$ds^2 = \left(1 + \frac{L^4}{r^4}\right)^{-\frac{1}{2}} (-dx_0^2 + dx_1^2 + dx_2^2 + dx_3^2) + \left(1 + \frac{L^4}{r^4}\right)^{\frac{1}{2}} (dr^2 + r^2 d\Omega_5^2) \quad (3.20)$$

Where $d\Omega_5^2$ is the metric of a 5-sphere of unit radius, and the explicit form of L is given by [9] :

$$L = Ng_s 4\pi (\alpha')^2 \quad (3.21)$$

This geometry is particularly interesting, and is in fact where the ‘‘AdS’’ in AdS/CFT comes from. We will study this more closely in section 3.3.

3.2.3 A more stringy description of branes

As it turns out, branes also have a realisation in superstring theory, not just SUGRA. As one could expect, they reduce to SUGRA branes in the low energy limit and are subject to corrections otherwise.

However, the way we think of them in string theory is different, and will be conceptually important later.

A D brane is simply a surface where fundamental strings (which couple electrically to the B_2 field) can have an endpoint. More formally, if X^μ represents the worldsheet of an open string, we impose Neumann boundary conditions along the brane directions, and Dirichlet boundary conditions along the others:

$$\partial_\sigma X^\mu = 0 \quad \text{for } \mu = 0, \dots, p \quad (3.22)$$

$$X^\mu = 0 \quad \text{for } \mu = p + 1, \dots, d \quad (3.23)$$

Where σ are the worldsheet coordinates.

In this picture, open strings can propagate along the brane, but their endpoints are tied. What we obtain is the spacetime bulk where closed strings propagate more or less freely, but interact with the open strings near the branes [40].

3.2.4 Brane Worldvolume and symmetries

So far, we've slowly built up the gravity side of our correspondence. Let's look a little bit more closely at it, and see if we can start to see some similarities with $\mathcal{N} = 4$ SYM.

The first hint comes when one looks at the worldvolume of these D3 branes. First, note that when we place a D3 brane in our spacetime, we break translational symmetry along $10 - 4 = 6$ directions. As a result, due to the Higgs mechanism, we get 6 scalar fields living on the branes.

In our case, there is additional symmetry to consider. For N branes, we get modes corresponding to strings originating from one brane, and ending on another.

When two branes are separated by a distance r , then the minimum length of the string that stretches between these is r . It consequently has a tension, and in fact corresponds to a massive W-Boson propagating on the brane.

When a string starts and ends on the same brane, it has no tension, and corresponds to a massless mode.

When all the branes are coincident, such as in our case, all the modes become massless. Noting that strings are oriented, we can easily see that there are N^2 of them. This is in fact a realisation of the gauge group of the fields

living on the brane, namely $U(N)$. This is illustrated in figure 3.1. In actuality $U(N) \cong U(1) \times U(N)$ and the $U(1)$ factor corresponds to the position of the center of mass of the branes.

So in the end, on this stack of D3 branes, we obtain 6 scalars each in the adjoint representation of the gauge group $SU(N)$. It is no coincidence that this looks like $\mathcal{N} = 4$ SYM, as in fact $\mathcal{N} = 4$ SYM lives on the worldvolume D3 branes!

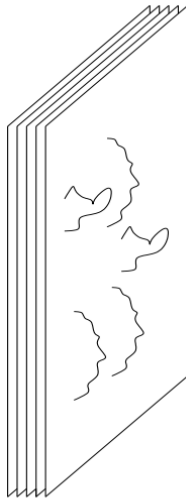

Figure 3.1: N Parallel D3 branes stacked on top of each other. The different strings stretching between each brane corresponds to a different mode [9].

Finally, we mention a symmetry that we have overlooked so far. The action of Type IIB SUGRA, actually has an $SL(2, \mathbb{R})$ symmetry. To make it manifest, one follows the steps in [9]. If one defines:

$$\tau = C + ie^{-\Phi} \tag{3.24}$$

then the symmetry is :

$$\tau \rightarrow \frac{a\tau + b}{c\tau + d} \quad \text{where } ad - bc = 1, \quad a, b, c, d \in \mathbb{R} \tag{3.25}$$

When we take this to string theory, the instanton angle, $\theta_I = 2\pi C$ is quantised, and we identify $\theta_I \sim \theta_I + 2\pi$. As a result, the symmetry becomes $SL(2, \mathbb{Z})$, not dissimilarly to Montonen-Olive Duality from section 2.3.1 . . .

3.3 The D3 metric, and AdS Spacetime

In this section, we will work a little more closely with (3.20). This geometry is rather interesting, and looks like a throat, as depicted in figure 3.2

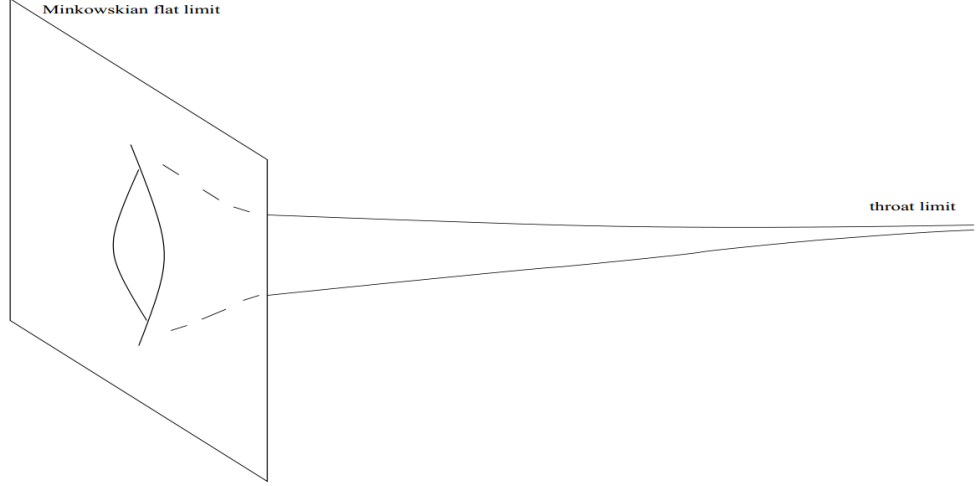

Figure 3.2: Geometry of N D3 branes [9].

To show this, it suffices to take the two limits of r . For $r \gg L$, the metric simply reduces to d-dimensional Minkowski space. However, in the limit of $r \ll L$, we get

$$ds^2 \approx \frac{r^2}{L^2}(-dx_0^2 + dx_1^2 + dx_2^2 + dx_3^2) + \frac{L^2}{r^2}(dr^2 + r^2 d\Omega_5^2) \quad (3.26)$$

This is in fact the metric of an Anti-de Sitter spacetime, namely AdS_5 . To see this, we will begin by explaining AdS in more depth.

3.3.1 Anti De-Sitter Space

Lorentzian AdS_{p+2} spacetime can be described in flat Lorentzian space, $\mathbb{R}^{2,p+1}$ which has the metric:

$$ds^2 = -dX_0^2 - dX_{p+2}^2 + \sum_{i=1}^{p+1} dX_i^2 \quad (3.27)$$

via the embedding:

$$X_0^2 + X_{p+2}^2 - \sum_{i=1}^{p+1} dX_i^2 = R^2 \quad (3.28)$$

At this point, there are two sets of coordinates which will be interesting for us. The first set is called *global coordinates*:

$$X_0 = R \cosh \rho \cos \tau \quad (3.29)$$

$$X_{p+2} = R \cosh \rho \sin \tau \quad (3.30)$$

$$X_i = R \sinh \tau z_i \quad \text{where } \sum_{i=1}^p z_i = 1 \quad (3.31)$$

Plugging this in (3.27), we get the AdS_{p+2} metric in global coordinates:

$$ds^2 = R^2(-\cosh^2 \rho d\tau^2 + d\rho^2 + \sinh^2 \rho d\Omega_p^2) \quad (3.32)$$

Where $\rho \in \mathbb{R}^+$ and $0 \leq \tau \leq 2\pi$. This covers all of the hyperboloid. If we look at the spacetime near $\rho = 0$, it becomes conformally flat, and thus quite simple. Note that the “time” coordinate τ is compact, and leads to the possibility of closed timelike curves. If we wish to remove them, on physical grounds, we simply do not identify $\tau = 0$ with $\tau = 2\pi$, and the spacetime looks Minkowskian.

We now look at the other extreme. To do so, we change coordinates once more, with

$$\tan \theta \equiv \sinh \rho \quad 0 \leq \theta \leq \pi/2 \quad (3.33)$$

which leads to

$$ds^2 = \frac{R^2}{\cos^2 \theta}(-d\tau^2 + d\theta^2 + \sin^2 \theta d\Omega_p^2) \quad (3.34)$$

To see what happens at $\rho \rightarrow \infty$ which corresponds to $\theta = \pi/2$ we can simply perform a conformal rescaling by $\cos^2 \theta / R^2$ as these leave the causal structure invariant. This gives us:

$$ds^2 = -d\tau^2 + d\theta^2 + \sin^2 \theta d\Omega_p^2 \quad (3.35)$$

Asymptotically, this is the geometry of $S^p \times \mathbb{R}$, and not Minkowski space.

Now, we move on to a new set of coordinates which will be useful for us to relate to the D3 brane geometry. These are called Poincaré coordinates, (u, t, x^i) , $i = 0 \dots p$ defined by:

$$X^0 = \frac{1}{2} \left(u + \frac{1}{u} (R^2 + x^i x^j \delta_{ij} - t^2) \right) \quad (3.36)$$

$$X^i = \frac{R x^i}{u} \quad (3.37)$$

$$X^{p+1} = \frac{1}{2} \left(u + \frac{1}{u} (R^2 + x^i x^j \delta_{ij} - t^2) \right) \quad (3.38)$$

$$X^{p+2} = \frac{R t}{u} \quad (3.39)$$

Again, these coordinates satisfy (3.28), although they only cover half of the hyperboloid. When plugged in (3.27), it gives us a new form for the metric:

$$ds^2 = R^2(u^2(-dt + dx^i dx^j \delta^{ij}) + \frac{du^2}{u^2}) \quad (3.40)$$

Finally, we do a final change of coordinates: $u \equiv 1/z$ to get:

$$ds^2 = \frac{R^2}{z^2}(\eta_{ij} dx^i dx^j + dz^2) \quad (3.41)$$

Going back to (3.26), we see that if one defines the coordinate:

$$z \equiv \frac{L^2}{r} \quad (3.42)$$

then we get the metric:

$$ds^2 = L^2\left(\frac{1}{z^2}\eta_{ij} dx^i dx^j + \frac{du^2}{z^2} + d\Omega_5\right) \quad (3.43)$$

Thanks to (3.41), it is now easy to recognise the *AdS* in this metric. In fact the full geometry is simply that of $AdS_5 \times S^5$, where *both* the 5-sphere and the Anti de-Sitter spacetime have the same radius of curvature, L . [1][11]

Chapter 4

The AdS/CFT Correspondence

Finally, it is time to explicitly state the correspondence. However, before we go and build a dictionary, let us motivate this correspondence even more and see where the idea came from.

4.1 The Decoupling Argument

This argument was presented in 1998 by Maldacena in a seminal paper, [30]. Let us consider Type IIB super string theory in a flat 10-dimensional spacetime, $\mathbb{R}^{1,9}$ with N D3 branes stacked on top of each other. We will consider two different limits in turn.

1. $\lambda \ll 1$ limit

We said earlier that D branes were surfaces where open strings can end. However, another view is to say that they are surfaces capable of emitting closed strings (as depicted in Figure 4.1). Now this gives us an insight into what the form of the “tension” of the brane is. Perturbative string theory is defined as a genus expansion of the worldsheet, and we have the result that the string amplitude is proportional to g_s^{2-2g-b} where g is the genus of the surface, and b is the number of boundaries.

In the case of a brane emitting a string, the surface is a disc with $g = 0$ and $b = 1$, and so

$$T_{brane} \propto \frac{1}{g_s} \tag{4.1}$$

Tension is additive, and so in the case of N D3 branes, we get that the stress tensor is [34]:

$$T_{\mu\nu}^{branes} \propto \frac{N}{g_s} \tag{4.2}$$

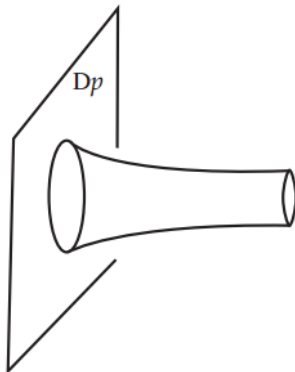

Figure 4.1: A brane emitting a closed string, this process is governed by a disk amplitude. [33]

Now, the flat background will be disturbed by the presence of the massive objects that are the D3 branes. This is determined by the all-familiar Einstein equations:

$$R_{\mu\nu} - \frac{1}{2}Rg_{\mu\nu} = 8\pi G_{10}T_{\mu\nu}^{branes} \quad (4.3)$$

Following [26], we know that Newton's constant in 10 dimensions, G_{10} behaves as $G_{10} \propto g_s^2$, so we see that the RHS of (4.3) is proportional to $g_s N \equiv \lambda$ where λ is known as the " 't Hooft coupling "

In the limit where λ is small, the backreaction of the branes (ie the deformation to flat spacetime that the branes cause) is infinitesimal. Essentially, we have D3 branes floating in flat spacetime. If we are interested in the low energy limit, that is to say when energies are smaller than the string scale $1/l_s$, we see an interesting decoupling. In this regime, there is not enough available energy to excite massive modes, so there are only massless modes. There are two possible types of massless excitations in this picture: Closed strings in the bulk, and open strings on the branes. We can thus write a total effective action:

$$S_{eff} = S_{bulk} + S_{int} + S_{branes} \quad (4.4)$$

Above S_{bulk} are the excitations in the bulk, and in the low energy limit, simply corresponds to the Type IIB action, and string corrections can be ignored. S_{branes} corresponds to the field theory living on the branes, and is simply $\mathcal{N} = 4$ SYM as we saw before. S_{int} describes the interactions between the closed strings in the bulk and the open strings near the branes.

This simply goes to zero in the low energy limit, and we thus have two decoupled systems [1]:

$$\text{Type IIB SUGRA} \oplus \mathcal{N} = 4 \text{ SYM with } SU(N) \text{ gauge group} \quad (4.5)$$

2. $\lambda \gg 1$ limit

We now look at the opposite end of the spectrum, the strong coupling limit. Here, the D3 branes strongly back react on the spacetime, and so instead of looking at our system as a string theory in a flat background with branes at some point, we just look at it as a string theory living in the spacetime of (3.20).

The next step is to look at the low energy limit once more. Again, there are two kinds of excitations.

Once again, we have massless propagating away from the “throat”, which is essentially flat spacetime. It turns out that these modes cannot reach the rest of the geometry. Intuitively, we understand that this is due to the fact that at low energies, ie. long wavelengths, the modes cannot fit down the throat. A little bit more formally, it can be shown (eg in [19]) that the absorption cross section for the D3 brane goes like $\sigma \sim \omega^3 R^8$ so for small ω , it becomes 0.

The other kind of excitations live at $r \ll L$, the region of spacetime which is $AdS_5 \times S^5$. These excitations cannot escape the the throat either, much like particles cannot escape a black hole.

So we have another decoupling, and our system is described by

$$\text{Type IIB SUGRA} \oplus \text{Type IIB string theory on } AdS_5 \times S^5 \quad (4.6)$$

We now have an interesting result. Comparing (4.5) and (4.6), we see that both pictures have closed string modes propagating in the bulk.

We will now make a cavalier move, and declare the following:

Type II B string theory on an $AdS_5 \times S^5$ background is equivalent to $\mathcal{N} = 4$ SYM with $SU(N)$ gauge group.

Before moving on, we remind that these two pictures were taken at completely different limits of λ . This fact is extremely powerful: for small coupling, the gauge theory can be defined in terms of perturbative expansion, while the classical gravity description fails. For large coupling, the opposite is true! This means that we can learn things about both theories in the respective regimes that aren’t easily tractable.

This is a double-edged sword however, as it also means that the correspondence is extremely hard to prove - for now we it must stay at the level of conjecture.

Instead, what we can do, is look for observables and features of the theories that are independent of λ and compare them. Using this, a lot of evidence has been found in favour of the duality.

4.2 Making The Correspondence Precise

We have finally made the statement that we have been trying to make since the beginning. Now it is time to be more accurate about it.

Firstly, a word about semantics. What does it mean for two completely different theories like Type IIB and SYM to be dual? It means that we can create an explicit map between parameters and features of the theories. An important endeavour in the duality is to build a dictionary between the two. We will now start to match aspects of both theories explicitly.

4.2.1 Matching Parameters

We will begin by matching the different parameters the theories:

Type IIB on $AdS_5 \times S^5$ $g_s, R, l_s, \langle C \rangle$	$\mathcal{N} = 4$ SYM with $SU(N)$ g_{YM}, θ_I, N
$4\pi g_s = g_{YM}^2$ $2\pi \langle C \rangle = \theta_I$ $\frac{R^4}{l_s^4} = 4\pi g_s N = g_{YM}^2 N = \lambda$	

With these identifications, it is interesting to look at the 't Hooft limit, which consists in taking $N \rightarrow \infty$ while keeping λ fixed. $\mathcal{N} = 4$ SYM is solely composed of adjoint-valued fields so the discussion of Section 2.5 applies. Taking the 't Hooft limit therefore implies that as long as λ is small enough our theory on the gauge side is described by an expansion of only planar feynman diagrams. On the gravity side, the limit means that $g_s = \lambda/N$ goes to zero, so we are dealing with classical string theory. This is an important result as it allows us to compute more tractable calculations. [1].

4.2.2 Matching Symmetries

We now map the global symmetries of both sides. First, we look at the bosonic subgroup of SYM: $SO(2, 4) \times SO(6)_R$. This can very simply mapped to the isometries of $AdS_5 \times S^5$. Indeed, by construction it is easy to see that AdS_{d+2} has $SO(2, d+1)$ symmetry from (3.28). Together with the $SO(6)$ symmetry of the S^5 , the bosonic symmetries are the same.

If we include the fermionic generators, we also get the same group. Indeed,

Type IIB has 32 supercharges as we explained earlier. On the other side $\mathcal{N} = 4$ SYM starts with 16 fermionic generators, but when we include the S charges from conformal symmetry, we also get 32. So overall, both theories enjoy an $SU(2, 2|4)$ symmetry.

Finally, S-duality is seen in both theories as discussed in sections 2.3.1 and 3.2.4 respectively. So again, there is a one to one mapping between the two symmetries since following section 4.2.1 we see that:

$$\tau = \frac{i}{g_s} + C = \frac{4\pi i}{g_{YM}^2} + \frac{\theta_I}{2\pi} = \tau_{YM} \quad (4.7)$$

4.2.3 Matching Representations

Now that we have mapped the symmetries of both theories, we should be able to find a one-to-one mapping between their respective representations. What we expect is to find for each field in the bulk, a corresponding operator on the boundary. We have already talked in section 2.3.2 about the different representations on the gauge side. Fields from the gravity side will simply come from the compactification of Type IIB degrees of freedom on $AdS_5 \times S^5$.

The best way to map fields to operators is to abuse the symmetry of both theories. If we find fields that are in a certain representation of the S^5 isometries, and that scale a certain way, we can confidently match them to operators with corresponding $SU(4)_R$ and $SO(1, 1)$ (which corresponds to conformal symmetry) quantum numbers.

To illustrate this, we will look at the compactification of a scalar field on the gravity side, such as the dilaton, and see what we get on the gauge side. To do this, we first introduce a *key element* of the AdS/CFT dictionary. On the gravity side, we should be able to write down a partition function for the fields, say ϕ , which will be a function of the boundary condition ϕ_0 . Then, the dictionary says that this is equivalent to the generating functional for the corresponding operator on the gauge side, \mathcal{O} :

$$\mathcal{Z}_{bulk}[\phi_0(x^\mu)] = \langle e^{\int d^4x \phi_0(x^\mu) \mathcal{O}(x^\mu)} \rangle_{CFT} \quad (4.8)$$

We are now ready to compactify the Dilaton on $AdS_5 \times S^5$. We proceed by separating the coordinates into x on AdS_5 and y on S^5 . We then expand fields as spherical harmonics on S^5 . For example, for a field $\Phi(x, y)$ we write:

$$\Phi(x, y) = \sum_{l=0}^{\infty} \Phi^l(x) Y^l(y) \quad (4.9)$$

Where $Y^l(y)$ are scalar spherical harmonics which can be written as:

$$Y^l(y) = T_{I_1 \dots I_l} y^{I_1} \dots y^{I_l} \quad (4.10)$$

where $I = 1 \dots 6$ and $\sum_I (y^I)^2 = 1$. Already, we can see that this is in the 1th symmetric traceless representation of the S^5 isometry group, $SO(6) \sim SU(4)$ $[0, l, 0]_{SU(4)}$. What is more, from the equations of motion, we find that dimensionally reduced modes with angular momentum l acquire a Kaluza Klein mass:

$$m_l^2 R^2 = l(l + 4) \quad (4.11)$$

where R is the radius of the 5-sphere

Now we focus on the AdS_5 , with radius R , where we will take the metric to be

$$ds^2 = \frac{R^2}{z^2} (dx^2 + dz^2) \quad (4.12)$$

so we separate x into (x^μ, z) . the determinant of the metric is:

$$\det(g_{\mu\nu}) = g = \frac{R^{10}}{z^{10}} \quad (4.13)$$

If we just consider a massive scalar field, ϕ its action will be:

$$S \sim R^5 \int d^4x dz \sqrt{g} (g^{\mu\nu} \partial_\mu \phi \partial_\nu \phi + m^2 \phi^2) \quad (4.14)$$

integrating by parts and ignoring the boundary terms, we get the usual Klein-Gordon equation:

$$(\square - m^2)\phi = 0 \quad (4.15)$$

now in our case,

$$\square \phi = \frac{1}{\sqrt{g}} \partial_A (\sqrt{g} g^{AB} \partial_B \phi) \quad (4.16)$$

Where $A, B = 0 \dots 4$. The metric is easy to invert as it is diagonal, and so we get:

$$\frac{1}{R^2} (z^2 (\partial_x \phi)^2 + z^5 \partial_z (\frac{1}{z^3} \partial_z \phi) - m^2 R^2) \phi = 0 \quad (4.17)$$

which after going to Fourier space for the x coordinates gives:

$$(z^5 \partial_z (\frac{1}{z^3} \partial_z \phi) - z^2 p^2 - m^2 R^2) \phi = 0 \quad (4.18)$$

Solving this is rather involved, and requires knowledge of Bessel functions, however we can simplify it greatly by looking at its behaviour near the boundary of AdS , ie. for $z \rightarrow 0$. To do this, we assume ϕ to be of the form $\phi(x^\mu, z) \propto z^\alpha \phi_0(x^\mu)$, write $z = \epsilon$, and take $\epsilon \rightarrow 0$ at the end. This gives:

$$(\alpha(\alpha - 4) - p^2 \epsilon^2 - m^2 R^2) \epsilon^\alpha = 0 \quad (4.19)$$

In the near boundary limit, we can ignore the second term, and we get two solutions:

$$\alpha_{\pm} = 2 \pm \sqrt{4 + m^2 R^2} \quad (4.20)$$

Near the boundary, the α_- solution dominates. We thus impose the boundary condition:

$$\phi(x^\mu, z)|_{z=\epsilon} = \phi_0(x^\mu, \epsilon) = \epsilon^{\alpha_-} \phi_0^r(x^\mu) \quad (4.21)$$

where ϕ_0^r is a finite function the near boundary limit and is called the “renormalised boundary condition”. From equation (4.8), we see that a perturbation of ϕ_0 in the bulk corresponds to the insertion of an operator in the field theory that lives on the boundary.

Now, since $\phi(x^\mu, z)$ is a scalar of AdS , we know that under a rescaling of the form $x \rightarrow \lambda x$ and $z \rightarrow \lambda z$, it is invariant. This implies that ϕ_0^r has dimension α_- . We now look back at (4.8), with the new notation (so we now have $\phi_0^r(x^\mu)$ in the integral). We know that the operator’s dimension is its D eigenvalue, Δ , and since the exponent is dimensionless, we can say with certainty:

$$4 - \alpha_- = \alpha_+ = \Delta \quad (4.22)$$

And so, from (4.20) we can relate the masses of scalar fields in the bulk to the dimension of operators on the boundary:

$$m^2 R^2 = \Delta(\Delta - 4) \quad (4.23)$$

Moreover, since fields are Kaluza-Klein reduced and have acquired mass through their angular momentum number on S^5 , as in (4.11), we can say that a mode with angular momentum l has dimension

$$\Delta = 4 + l \quad (4.24)$$

We now have enough information to map these modes to operators of the CFT: These modes correspond to operators in the $[0, l, 0]$ representations of $SU(4)_R$ and have dimension $\Delta + 4$. These are :

$$Tr(F^2 X^{i_1} \dots X^{i_l}) \quad (4.25)$$

[32], [35]. Before moving on, it is interesting to note that in the example above, the fact that AdS had a boundary had drastic implications on the gravity fields. We obtained modes with differing boundary behaviour: $z = 0$, we have:

$$\begin{cases} \phi(x, z) \sim z^{4-\Delta} \text{ which are known as non-normalizable modes} \\ \phi(x, z) \sim z^\Delta \text{ which are known as normalizable mode.} \end{cases} \quad (4.26)$$

We already saw what the non-renormalizable corresponded to in the boundary field theory. As for the normalizable modes, these determine the vacuum expectation values of the corresponding operators in the CFT. [46]

Interestingly enough we find that KK-modes of Type IIB supergravity fields can be mapped one-to-one with operators in the protected multiplets of SYM. Following the work of [20] and [27], we can map representations of the different KK modes of type IIB to superconformal primary operators of SYM and its descendants. For a complete list, see table 7 of [9].

Massive string modes on the gravity side will correspond to non-protected multiplets (ie. multiplets that are neither SPO or descendants). Indeed, these string modes will have masses of the order $m \sim 1/l_s$, which according to (4.23) should correspond to operators with dimension:

$$\Delta \sim R/l_s \sim (g_{YM}^2 N)^{1/4} \quad (4.27)$$

which evidently scales with the Yang-Mills coupling.

Multi-particle states will correspond to products of operators taken at different points.

Bound states will correspond to products of operators taken at the same point. [10] [1]

4.2.4 Matching Correlation Functions.

We have now matched simple operators, but a more interesting endeavour would be to match full correlation functions. If we recall section 2.1.4, conformal symmetry gave powerful constraints on the theory's correlation functions and in fact, it completely fixed 2 and 3-point functions. We would like to check if we can reproduce this result on the gravity side. If we are successful and we manage to obtain the same results as before for these correlation functions, this should give another nice check of the correspondence. In what follows, ϕ represents any field in the gravity theory, not just scalars.

In order to compare the correlation functions, we must again make use of the key equation (4.8). More precisely, as an action for the full type IIB string theory is hard to obtain, we will only consider the low energy approximation - ie. SUGRA on the LHS. This corresponds to taking $\lambda \rightarrow \infty$ and also $N \rightarrow \infty$. As we saw before, when solving the equations of motion, we impose some Dirichlet boundary condition: $\phi(x^\mu, \epsilon) = \phi_0(x^\mu)$ and we take $\epsilon \rightarrow 0$ at the end so that this is at the boundary of *AdS*. If we then assume that the equations of motion are unique (ie. that there is a unique saddle point for the action), we can refine (4.8) into:

$$-\log \langle e^{\int d^4x \phi_0(x^\mu) \mathcal{O}(x^\mu)} \rangle_{CFT} = W_{CFT}[\phi_0(x^\mu)] = \text{extremum}(S_{IIB}[\phi]) \Big|_{\phi=\phi_0} \quad (4.28)$$

Where W_{CFT} is the generating functional for connected correlators in the gauge theory. Taking functional derivatives with respect to the ϕ_0 and then setting it to 0 then allows us to obtain connected correlators of \mathcal{O} .

What we seek to do, is to solve the equations of motion for the classical gravity action with the boundary conditions, and perform the functional derivatives. This leads to a diagrammatic expansion similar to Feynman diagrams. These are called Witten diagrams and are represented by a disc. Two examples are seen in Figure 4.2.

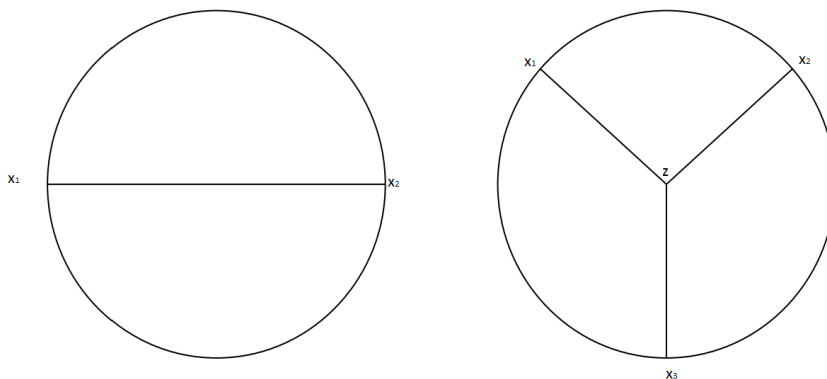

Figure 4.2: Two examples of Witten diagrams. The diagram on the left corresponds to two-point functions, the one on the right corresponds to three-point functions.

The interior of the disc represents the bulk of AdS , and the circle is the boundary. These diagrams are similar to Feynman diagrams, except they have two types of propagators:

- Bulk-to-bulk propagators, which are the usual Green's functions that we are used to, relating two points in the bulk.
- Boundary-to-bulk propagators, which are the limit of bulk-to-bulk propagators where one of the points is on the boundary.

We note that in the current limit, the gravity action is classical, so there will be no loop diagrams in the bulk. However, it is interesting to note that if we wish to include quantum corrections with up to n loops, this corresponds to including diagrams living on surfaces with a genus up to n on the CFT side. For now, though, we only have planar diagrams contributing. We will now derive a form for the two and three point functions from the gravity side.

2-pt functions

We will focus on a toy scalar model, before relating it to the action of type

IIB SUGRA. Since we are looking at two point functions, the only terms that will survive on the RHS of (4.28) are the quadratic terms. So we take the action to be:

$$S[\phi] = \int d^4x dz \sqrt{g} \left(\frac{1}{2} g^{AB} \partial_A \phi \partial_B \phi + \frac{1}{2} m^2 \phi^2 \right) \quad (4.29)$$

The equation of motion that we get is again,

$$\left[z^5 \frac{\partial}{\partial z} \left(z^3 \frac{\partial}{\partial z} \right) + z^2 \frac{\partial^2}{\partial x^2} - m^2 \right] \phi(x^\mu, z) = 0 \quad (4.30)$$

We gave an Ansatz earlier, but this time we will proceed more carefully, and follow [53], [16], which consists in finding a Green's function for 4.30. In other words, we are looking for a function that diverges only on the boundary. Not only that, but if we recall (4.21), we see that the boundary condition, ie. the source, actually comes with a factor of $z^{4-\Delta}$, so we would like the Green's function, K , to satisfy:

$$z^{\Delta-4} K(z, x^\mu, x'^\mu) \rightarrow \delta(x^\mu - x'^\mu) \quad (4.31)$$

as $z \rightarrow 0$. In order to find it, we can use isometries of AdS : if the metric is in Poincaré coordinates it is invariant under :

$$x^\mu = \frac{x'^\mu}{z^2 + x'^2} \quad (4.32)$$

$$z = \frac{z'}{z^2 + x'^2} \quad (4.33)$$

If we then recall (4.26), there is a solution,

$$\phi(x^\mu, z) = c_\Delta z^\Delta \quad (4.34)$$

for some constant c_Δ , which diverges as $z \rightarrow \infty$. Performing the inversion above, we get a function:

$$K(z, x^\mu, 0) = c_\Delta \left(\frac{z}{z^2 + x^2} \right)^\Delta \quad (4.35)$$

note that by definition, the Green's function will actually be a function of $x^\mu - x'^\mu$ when $x'^\mu \neq 0$. This form of K behaves as we want it:

1. it goes to 0 as $z \rightarrow \infty$
2. it is 0 at $z = 0$ except for $x^2 = 0$, where it diverges.
3. if we choose the normalization

$$c_\Delta = \frac{\Gamma(\Delta)}{\pi^2 \Gamma(\Delta - 2)} \quad (4.36)$$

then it obeys (4.31).

We can now solve (4.30), with the boundary condition (4.21):

$$\phi(x^\mu, z) = \frac{\Gamma(\Delta)}{\pi^2 \Gamma(\Delta - 2)} \int d^4 x' K(z, x^\mu, x'^\mu) \phi_0(x'^\mu) \quad (4.37)$$

With a solution for out field, it is now time to evaluate our action on-shell. We proceed by integrating (4.29) by parts. This gives:

$$S[\phi] = \int d^4 x dz (\partial_A (\sqrt{g} g^{AB} \phi \partial_B \phi) - \phi \partial_A (\sqrt{g} g^{AB} \partial_B \phi) + \sqrt{g} m^2 \phi^2) \quad (4.38)$$

$$= \int_{AdS} \sqrt{g} (-\square + m^2) \phi + \int_{\partial AdS} \sqrt{\gamma_\epsilon} \phi \mathbf{n} \cdot \nabla \phi \quad (4.39)$$

where γ_ϵ is the induced metric on the boundary of AdS (ie. $z = \epsilon$), \mathbf{n} is the unit vector pointing outwards from the surface and to go from (4.38) to (4.39) we used Stokes' theorem. When we are on shell, the first term drops out. Then, since $\sqrt{\gamma_\epsilon} = (\frac{R}{\epsilon})^4$ and since \mathbf{n} is a unit vector, $\mathbf{n} \cdot \nabla \phi = \frac{\epsilon}{R} \frac{\partial}{\partial z} \phi$ so we are left with:

$$S_{on-shell}[\phi] = \int_{\partial AdS} \left(\frac{R}{\epsilon}\right)^3 \phi(x, z) \frac{\partial}{\partial z} \phi(x, z) \quad (4.40)$$

$$= \int d^4 x d^4 x' d^4 x'' \left(\frac{R}{\epsilon}\right)^3 K(\epsilon, x, x') \left(\frac{\partial}{\partial z} K(z, x, x'')\right) \Big|_{z=\epsilon} \phi_0(x') \phi_0(x'') \quad (4.41)$$

Then, when we take the limit of $\epsilon \rightarrow 0$, we can use (4.31) to get:

$$S_{on-shell}[\phi] = R^3 \epsilon^{1-\Delta} \int d^4 x d^4 x' \left(\frac{\partial}{\partial z} K(z, x, x')\right) \Big|_{z=\epsilon} \phi_0(x') \phi_0(x'') \quad (4.42)$$

now, if we define $x - x' \equiv r$, we compute

$$\frac{\partial}{\partial z} K(z, x, x') = c_\Delta \Delta \frac{z^{\Delta-1} (z^2 + r^2)^\Delta - 2z^{\Delta+1} (z^2 + r^2)^{\Delta-1}}{(z^2 + r^2)^{2\Delta}} \quad (4.43)$$

$$= c_\Delta \Delta \frac{z^{\Delta-1}}{r^{2\Delta}} + \mathcal{O}(z^{\Delta+1}) \quad (4.44)$$

plugging this in in (4.42) and taking $\epsilon = 0$, gives:

$$S_{on-shell}[\phi] = R^3 \Delta \frac{\Gamma(\Delta)}{\pi^2 \Gamma(\Delta - 2)} \int d^4 x d^4 x' \frac{\phi_0(x) \phi_0(x')}{(x - x')^{2\Delta}} \quad (4.45)$$

we are finally in a position to calculate the two point function of the operator \mathcal{O} , with conformal dimensions Δ by taking functional derivatives:

$$\langle \mathcal{O}(x_1) \mathcal{O}(x_2) \rangle = \frac{\delta}{\delta \phi_0(x_1)} \frac{\delta}{\delta \phi_0(x_2)} S_{on-shell}[\phi] \Big|_{\phi_0=0} \quad (4.46)$$

$$= R^3 \Delta \frac{\Gamma(\Delta)}{\pi^2 \Gamma(\Delta - 2)} \frac{1}{(x_1 - x_2)^{2\Delta}} \quad (4.47)$$

There are several things to note about (4.47):

1. When we defined the action that we used, in (4.29), we were prescient of the fact that if we had included any terms of order higher than two, they would have dropped out at the end, when we set $\phi_0 = 0$
2. This result is in fact the correct form for the two point function! Indeed, this is of the same form as (2.25), up to a normalization factor. This is a strong argument in favour of the conjecture that we made when stating equation (4.8).

3-pt functions

We now move on to 3-point functions, which, if we recall section 2.1.4 are also special in that they are fixed by conformal symmetry. This time around, cubic terms will come into play when using equation (4.8). We therefore introduce a new toy model in which we have three scalars, $\phi_{1,2,3}$ with masses $m_{1,2,3}$ respectively, following the action:

$$S[\phi_i] = \int d^4x dz \sqrt{g} \left(\frac{1}{2} g^{\mu\nu} \partial_\mu \phi_i \partial_\nu \phi_i + \frac{1}{2} m_i^2 \phi_i^2 + \lambda \phi_1 \phi_2 \phi_3 \right) \quad (4.48)$$

This allows us to compute the correlation function for the three corresponding correlators $\mathcal{O}_{1,2,3}$ of dimension $\Delta_{1,2,3}$ respectively. This will correspond to the diagram on the right of 4.2, and is simply computed from Wick contraction of the propagators, but only to first order - recall that including higher order diagrams only makes sense in a lower N limit. As a result, we only need to compute:

$$\begin{aligned} \langle \mathcal{O}_1(x_1) \mathcal{O}_2(x_2) \mathcal{O}_3(x_3) \rangle &= \frac{\delta}{\delta \phi_0(x_1)} \frac{\delta}{\delta \phi_0(x_2)} \frac{\delta}{\delta \phi_0(x_3)} S_{on-shell}[\phi_i] \quad (4.49) \\ &= -\lambda \int d^4x dz K_{\Delta_1}(z, x, x_1) K_{\Delta_2}(z, x, x_2) K_{\Delta_3}(z, x, x_3) \quad (4.50) \end{aligned}$$

To evaluate this, we make use of symmetries to get rid of one of the propagator. Once again, we use inversion symmetry. It is convenient to call the 5-vectors, $X^A \equiv (z, x^\mu)$ and $Y^A \equiv (0, y^\mu)$. Then we make the inversion:

$$X^M = \frac{X'^M}{X'^2} \quad Y^M = \frac{Y'^M}{Y'^2} \quad (4.51)$$

and under this inversion, the propagator $K_\Delta(z, x, y)$ transforms as :

$$K_\Delta(z, x, y) \propto \left(\frac{z}{z^2 + (x - y)^2} \right)^\Delta = \left(\frac{z'/X'^2}{\left(\frac{X'}{X'^2} - \frac{Y'}{Y'^2} \right)^2} \right)^\Delta \quad (4.52)$$

$$= \left(\frac{z'/X'}{\frac{Y'^2 + X'^2 - 2X'Y'}{X^2 Y^2}} \right)^\Delta \quad (4.53)$$

$$= \left(\frac{z'Y'^2}{(X' - Y')^2} \right)^\Delta \quad (4.54)$$

$$= \left(\frac{z'}{z'^2 + (x' - y')^2} \right)^\Delta (y')^{2\Delta} \quad (4.55)$$

Meanwhile, the measure $d^4x' dz \sqrt{g}$ is invariant. In order to simplify (4.50) we simply perform this inversion on all 3 propagators, but we first make a translation so that $x_3 = 0$. In that case, under inversion, x_3 is mapped to $x'_3 \rightarrow \infty$, and looking at (4.55), we see that the denominator will cancel the factor of $(x'_3)^{2\Delta_3}$ so we are left with an extra factor of z'^{Δ_3} . We therefore have to evaluate:

$$-R^5 \lambda (x'_1)^{2\Delta_1} (x'_2)^{2\Delta_2} \int d^4x' dz' K_{\Delta_1}(z', x', x'_1) K_{\Delta_2}(z', x', x'_2) (z')^{\Delta_3} \quad (4.56)$$

$$= -R^5 \lambda \frac{1}{(x_1)^{\Delta_1}} \frac{1}{(x_2)^{\Delta_2}} \int d^4x' dz' \frac{1}{z'^5} \frac{z'^{\Delta_1 + \Delta_2 + \Delta_3}}{(z'^2 + (x' - x'_1)^2)^{\Delta_2} (z'^2 + (x' - x'_2)^2)^{\Delta_3}} \quad (4.57)$$

Solving this is done by using Feynman parameters. The result is computed in [16] and we find:

$$\langle \mathcal{O}_1(x_1) \mathcal{O}_2(x_2) \mathcal{O}_3(x_3) \rangle = \frac{a \lambda R^5}{(x_1)^{2\Delta_1} (x_2)^{2\Delta_2} (x'_1 - x'_2)^{\Delta_1 + \Delta_2 + \Delta_3}} \quad (4.58)$$

$$= \frac{a \lambda R^5}{(x_1)^{\Delta_1 + \Delta_3 - \Delta_2} (x_2)^{\Delta_2 + \Delta_3 - \Delta_1} (x_1 - x_2)^{\Delta_1 + \Delta_2 - \Delta_3}} \quad (4.59)$$

We now restore x_3 dependance by shifting $x_1 \rightarrow x_1 - x_3$ and $x_2 \rightarrow x_2 - x_3$ to get the final answer:

$$\frac{a \lambda R^5}{(x_1 - x_3)^{\Delta_1 + \Delta_3 - \Delta_2} (x_2 - x_3)^{\Delta_2 + \Delta_3 - \Delta_1} (x_2 - x_1)^{\Delta_1 + \Delta_2 - \Delta_3}} \quad (4.60)$$

The constant a is given by:

$$a = - \frac{\Gamma[\frac{1}{2}(\Delta_1 + \Delta_2 - \Delta_3)] \Gamma[\frac{1}{2}(\Delta_2 + \Delta_3 - \Delta_1)] \Gamma[\frac{1}{2}(\Delta_3 + \Delta_1 - \Delta_1)]}{2\pi^4 \Gamma[\Delta_1 - 2] \Gamma[\Delta_2 - 2] \Gamma[\Delta_3 - 2]} \Gamma[\frac{1}{2}(\Delta_1 + \Delta_2 + \Delta_3 - 4)] \quad (4.61)$$

This is very good news indeed. Once again, the we have recovered the spatial part of the correlator that we had in (2.31).

There exists non-renormalization theorems for 2- and 3-point functions that state that the coupling for these functions are the same in both sides of the correspondence. This is hard to show of course, as calculations can only be performed in different regimes, on respective sides of the duality. In [10], it is shown that in the limit of $N \rightarrow \infty$, The 3-point couplings on both sides are related by:

$$\lim_{N \rightarrow \infty} c_{\Delta_1 \Delta_2 \Delta_3}(g_{YM} = 0, N) \Big|_{SYM} = \lim_{N, \lambda \rightarrow \infty} c_{\Delta_1 \Delta_2 \Delta_3}(g_s, N) \Big|_{AdS} \quad (4.62)$$

While this is proved only for certain regimes, it is conjectured that it should hold for any λ , and, in the stronger form of the conjecture, for all N . [9]

A legitimate question to ask now is what this has to do with our story of Type IIB and $\mathcal{N} = 4$ SYM. We played around with these toy model, but in truth we should be dealing with the Type IIB action. What happens is that when Kaluza-Klein reducing the action on the compact manifold S^5 , we obtain different quadratic, as well as interacting terms. Some of the modes will correspond to the terms we studied, but there will be many more, such as terms involving derivatives, gauge fields etc. What is important is that we know the general form of the correlators can be recovered.

4.2.5 Wilson Loops

We will now look at Wilson loop operators in the context of the correspondence. An interesting viewpoint to adopt is the following. We consider that the endpoint of a string on our stack of D3 branes is a quark. In order to have a heavy quark needed to get Wilson loops, what we do is that we separate one of the branes from the stack and then push it back up the throat from figure 3.2.

The string that stretches between the lone “probe” brane to the rest is then a boson in the fundamental representation of the gauge group whose mass is proportional to the proper length of the string. Since the stack is at the boundary of AdS, this mass will be infinite, as required.

This picture comes with another subtlety. The endpoint of the string not only couples to the gauge field at the boundary, but also to the six scalars. This is because when we separate the brane, the gauge group breaks from $U(N)$ to $U(N - 1) \times U(1)$, giving an expectation value to the Higgs field. The definition of the Wilson loops operator then differs from (2.55). Instead we use:

$$W(\mathcal{C}) = \text{Tr} \mathcal{P} e^{-i \oint (A_\mu(x) \dot{x}^\mu + \theta^i X^i(x) \sqrt{\dot{x}^2}) dt} \quad (4.63)$$

Where θ^i is the unit 6-dimensional vector corresponding to the position on S^5 .

In this picture when the boson living on the boundary theory follows a Wilson loop, the string will follow it around in the bulk. Now if we recall the decoupling argument from section 4.1, we can adopt a different perspective in which the string in the bulk is moving in AdS . This motivates the dictionary rule for the Wilson loop operator: it corresponds to the partition function of the string. We thus try:

$$\langle W(\mathcal{C}) \rangle = e^{-S} \quad (4.64)$$

In the 't Hooft limit, we only consider classical string theory, and this action simplifies to the Nambu-Goto action, S_{NG} . The latter is just the minimal surface of the worldsheet traced by the string moving in AdS and following

the contour. It is given by:

$$S_{NG} = \frac{A}{2\pi\alpha'} = \int \frac{d\sigma d\tau}{2\pi\alpha'} \sqrt{\det(\partial_\alpha X^M \partial_\beta X^N g_{MN})} \quad (4.65)$$

Where $\alpha, \beta = 1, 2$ correspond to worldsheet coordinates.

This prescription is incomplete however, since the area will be infinite due to the fact that it goes all the way down to the boundary of AdS (the latter is an infinite proper distance away from the bulk). The correct procedure will then be to subtract the contribution from the worldsheet near the boundary, as show in figure 4.3. The interpretation on the gauge side is that we absorb

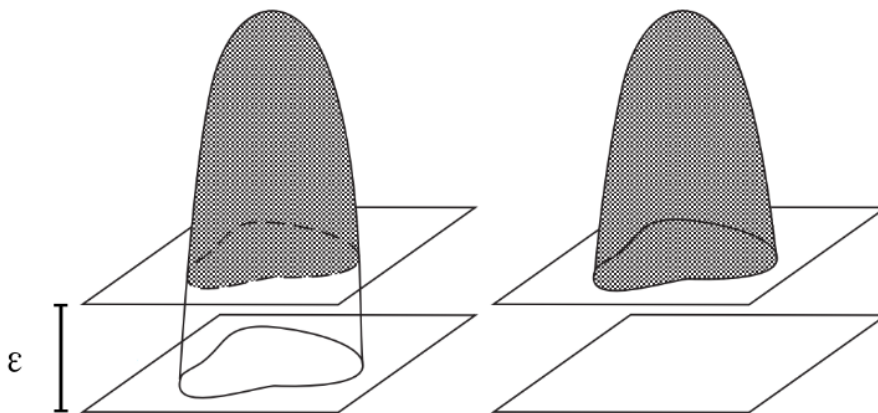

Figure 4.3: Regularization procedure in Wilson loop calculation. We introduce a cutoff in the radial direction, ϵ , and subtract the surface up to that point. [13]

divergent self-energy diagrams into a mass renormalization ¹. As a side note, we can observe that this is an IR divergence on the gravity side, but a UV divergence on the CFT side. This is true in general: since the AdS/CFT correspondence is a weak strong duality, IR divergences are mapped to UV divergences. [31], [13], [33]

For a few Wilson loops, this minimal surface computation is tractable, and we will do them here.

Circular loops We will first consider the case of a circular loops. This computation was done on the gauge side in [14] for all values of the coupling λ . The result is:

$$\langle W_{circle} \rangle = \frac{2}{\sqrt{\lambda}} I_1(\sqrt{\lambda}) \quad (4.66)$$

¹Note that in the case of BPS objects, there is no mass renormalization, but there is still a divergence coming from the area. The resolution of this problem is that the exponent of (4.64) should not be the area, but its Legendre transform as argued in [13].

Where I_1 is a Bessel function.

We will compare this with the gravity result in the 't Hooft limit, for which we have the behaviour:

$$\langle W_{circle} \rangle = \sqrt{\frac{2}{\pi}} \frac{e^{\sqrt{\lambda}}}{\lambda^{\frac{3}{4}}} \quad (4.67)$$

In order to proceed we will make use of an isometry of AdS: special conformal transformations. This technique is used in [7] and works as follows: We start with the trivial case of a line at the boundary. The minimal surface is then trivially a sheet extending from $z = 0$. For simplicity, let's say the line on the boundary is defined by $x_2 = x_3 = x_4 = 0$. By using the special conformal transformation:

$$x'_i = \frac{x_i + c_i x^2}{1 + 2c_i x_i + c^2 x^2} \quad (4.68)$$

where c_i are constants, we can turn the line into a circle at the boundary. To see this, we will take $b_3 = b_4 = 0$. Then, $x_2 = 0$ is mapped to:

$$x_2 + c_2(x_1^2 + x_2^2) = 0 \quad (4.69)$$

which is the constraint of a circle with radius $\frac{1}{2c_2} \equiv a$. However, in the full *AdS* space, the special transformation (4.68) generalises to:

$$x'_i = \frac{x_i + c_i x^2}{1 + 2c_i x_i + c^2(x^2 - z^2)} \quad (4.70)$$

$$z = \frac{z}{1 + 2c_i x_i + c^2(x^2 - z^2)} \quad (4.71)$$

The flat surface ending on a line, then gets mapped to the surface satisfying:

$$\vec{x} = \sqrt{a^2 - z^2}(\cos \theta, \sin \theta, 0, 0) \quad 0 \leq z \leq a \quad (4.72)$$

where above, θ are the usual polar coordinate for the x_1, x_2 plane at the boundary of AdS. In this parametrisation, for the worldsheet coordinates in (4.65) we simply say $\sigma = \theta$, $\tau = z$. We can then calculate:

$$\partial_z \vec{x} = -z(a^2 - z^2)^{-\frac{1}{2}}(\cos \theta, \sin \theta, 0, 0) \quad (4.73)$$

$$\partial_\theta \vec{x} = (a^2 - z^2)^{\frac{1}{2}}(-\sin \theta, \cos \theta, 0, 0) \quad (4.74)$$

the determinant of the induced metric is then:

$$\det(\partial_\alpha X^M \partial_\beta X^N g_{MN}) = \frac{L^4}{z^4} \begin{vmatrix} z^2(a^2 - z^2)^{-1} + 1 & 0 \\ 0 & a^2 - z^2 \end{vmatrix} \quad (4.75)$$

$$= \frac{L^4 a^2}{z^4} \quad (4.76)$$

and so, computing the action while remembering to take a cutoff at $z = \epsilon$

$$S_{NG} = \frac{L^2 a^2}{2\pi\alpha'} \int_0^{2\pi} d\theta \int_\epsilon^a dz \frac{1}{z^2} \quad (4.77)$$

$$= \frac{L^2 a}{\alpha'} \left(\frac{1}{\epsilon} - \frac{1}{a} \right) \quad (4.78)$$

$$(4.79)$$

The first term is subtracted when we remove the area corresponding to the cylinder length ϵ starting at the boundary. And so

$$S_{NG} = -\frac{L^2}{\alpha'} = -\sqrt{\lambda} \quad (4.80)$$

using the dictionary from section 4.2.1. Finally, we obtain:

$$W_{circle} = e^{\sqrt{\lambda}} \quad (4.81)$$

similarly to equation (4.67)! [7], [33].

Quark anti-quark potential Now let us see if we can perform the calculation from section 2.4 on the gravity side. To do this, we once again look for the minimal surface in AdS . The setup is shown in Figure 4.4. The

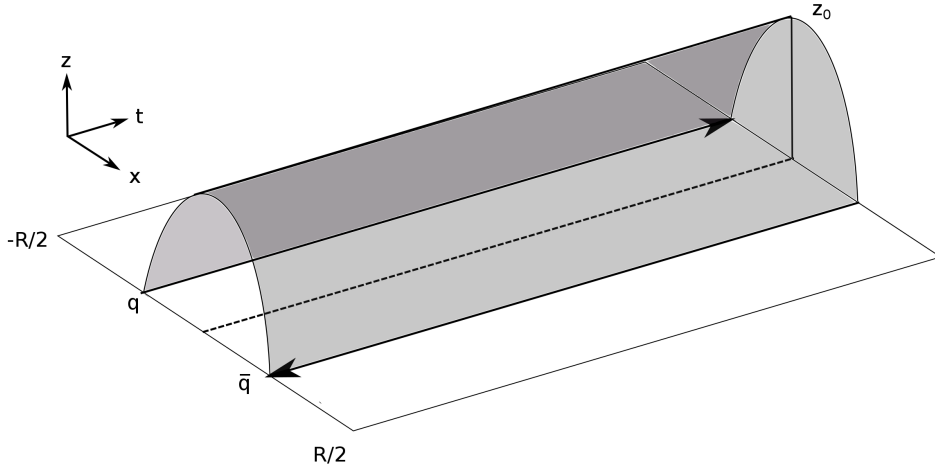

Figure 4.4: Wilson loop configuration. The rectangular surface represents the boundary of AdS while the shaded area corresponds to the minimum surface that we are looking for.

quarks on the boundary of AdS are propagating in one spatial direction, x ,

and time, t . Furthermore, we note that the solution is static and we can therefore take the worldsheet parametrization:

$$t = \tau \in [0, T] \quad x = \sigma \in [-R/2, R/2] \quad z = z(x) \quad (4.82)$$

We then proceed as before, to compute the Nambu-Goto action. First, we find that

$$\det(\partial_\alpha X^M \partial_\beta X^N g_{MN}) = \frac{L^4}{z^4} \begin{vmatrix} 1 + 0 + (z')^2 & 0 \\ 0 & 0 + 1 + 0 \end{vmatrix} \quad (4.83)$$

$$= \frac{L^4}{z^4} (1 + (z')^2) \quad (4.84)$$

where $z' = \frac{\partial z}{\partial x}$. Our task therefore becomes to compute the integral:

$$S_{NG} = \frac{L^2}{2\pi\alpha'} \int_0^T dt \int_{-R/2}^{R/2} dx \frac{\sqrt{1 + (z')^2}}{z^2} \quad (4.85)$$

To do this, we make use of symmetry once more. Indeed, one can notice that the hamiltonian density for this action is:

$$\mathcal{H} = \mathcal{L} - z' \frac{\partial \mathcal{L}}{\partial z'} = \text{constant} \quad (4.86)$$

and so we have the have that:

$$\frac{1}{z^2 \sqrt{1 + (z')^2}} = \text{constant} \quad (4.87)$$

Now, when $z' = 0$, z is at a maximum, z_0 , and so

$$\frac{1}{z^2 \sqrt{1 + (z')^2}} = \frac{1}{z_0^2} \quad (4.88)$$

First, we will determine z_0 in terms of the other parameters. We do this by noting that $z(0) = z_0$ and $z(-R/2) = 0$ and then:

$$R/2 = \int_{-R/2}^0 dx = \int_0^{z_0} dz \frac{1}{z'} = \int_0^{z_0} dz \frac{z^2}{\sqrt{z_0^4 - z^4}} \quad (4.89)$$

changing variables to $y \equiv z/z_0$ gives

$$R/2 = z_0 \int_0^1 dy \frac{y^2}{\sqrt{1 - y^4}} = z_0 \frac{\sqrt{2}\pi^{\frac{3}{2}}}{[\Gamma(1/4)]^2} \quad (4.90)$$

and so

$$z_0 = \frac{R[\Gamma(1/4)]^2}{2\sqrt{2}\pi^{\frac{3}{2}}} \quad (4.91)$$

Now we are finally in a position to solve (4.85). We do this by splitting this even integral, and changing the variable to z :

$$S_{NG} = 2 \frac{\sqrt{\lambda} T}{2\pi} \int_{\epsilon}^{z_0} dz \frac{z_0^2}{z^2 \sqrt{z_0^4 - z^4}} \quad (4.92)$$

Where we have remembered to include a cutoff. If we want to calculate the Wilson loop operator, we have to subtract the surface near the boundary of AdS . This is just the area of the two flat surfaces ending as lines. Overall, we have:

$$\ln \langle W_{q\bar{q}} \rangle = S_{NG} - \frac{2T\sqrt{\lambda}}{2\pi} \int_{\epsilon}^{z_0} \frac{dz}{z^2} \quad (4.93)$$

After the same substitution $y \equiv \frac{z}{z_0}$, this yields:

$$\ln \langle W_{q\bar{q}} \rangle = -\frac{2T\sqrt{\lambda}}{2\pi z_0} \int_{\epsilon/z_0}^1 \frac{dy}{y^2} \left(\frac{1}{\sqrt{1-y^4}} - 1 \right) \quad (4.94)$$

This can be computed (eg. using Mathematica) and yields a form for the potential, after taking $T \rightarrow \infty$:

$$V(R) = \lim_{T \rightarrow \infty} \frac{\ln \langle W_{q\bar{q}} \rangle}{T} = -\frac{\sqrt{\lambda}}{R} \frac{4\pi^2}{[\Gamma(1/4)]^4} \quad (4.95)$$

The nice thing about this result is that we can see that for low coupling,

$$V(R) \propto \frac{1}{r} \quad (4.96)$$

which is the deconfined behaviour we expected and computed back in (2.64)! [31], [50], [33].

For more computations involving Wilson loops in the AdS/CFT correspondence, involving more complex contours and a more in-depth look at renormalization procedures, see [14] [13], [12].

Chapter 5

Aspects of AdS/CFT and conclusion

We have reached a point where we have built up a robust foundation of AdS/CFT from scratch.

However, although at its birth the duality was just a surprising result of string theory, it is now a rapidly expanding field of research. In this chapter, we will attempt to outline a few of the possible ways that one can go further with the correspondence. In particular, we will discuss integrable systems, which have yielded many results in AdS/CFT. We will also talk about some of the more direct applications of the correspondence, namely its usefulness in Condensed Matter systems, or “AdS/CMT”.

Before moving on, one obvious direction we could take is to explore more examples of the duality. Indeed, when one considers a spacetime with coincident M5 branes, we obtain a duality between M-theory in $AdS_4 \times S^7$ and the (0,2) conformal field theory in 6 dimensions where (0,2) means that there are 4 supercharges of the same chirality. Similarly, considering Dp branes also yields different backgrounds. Moreover, one could consider different gauge groups by inserting orbifold planes in the spacetime [30] [19]. Another interesting direction is to break the supersymmetry in the theory. This can be done by replacing the S^5 by a conical manifold instead and placing the D3 branes at the apex. One can even go further and break the conformal symmetry of the dual gauge theory. This can be done by putting D5 branes wrapped around a sphere (S^2) at the apex. [25].

5.1 Integrability

One concern that we may have after 4.2, is the following: We mostly considered BPS objects protected by symmetry. It can therefore be argued that the similarities we found aren't a divine miracle, but merely a consequence

of the symmetry matching. It is therefore not surprising that we found the same results when mapping correlation functions, for instance. This begs the question: is there a better way to find evidence in favour of the correspondence? Ideally, we would like to find functions for both sides of the correspondence that allow us to determine an observable for all values of the coupling λ . One of the beauties of $\mathcal{N} = 4$ SYM is that this is actually possible! This is called integrability.

Integrable systems are simply ones that are completely solvable. However, these models are always two dimensional (or 1+1 dimensional if we work with Minkowskian signatures). How then can we apply this to our 4-dimensional theory?

Using our intuition from previous chapters, we might gain an insight as to how this arises. What, in our picture is two dimensional? The string worldsheet seems to be the obvious choice. Indeed, the latter is solvable, at least in the limit of free strings, $g_s = 0$. This translates to integrability of the planar expansion of $\mathcal{N} = 4$ SYM which is dominant when $N \rightarrow \infty$. In other words we obtain the 2 dimensional structure necessary for integrability from the structure of Feynman diagrams in that limit.

What does integrability give us precisely? On the gauge side, it gives us the scaling dimensions for operators in terms of λ . On the gravity side, this becomes a prediction for energies of (free) string states. In other words, If we have a general operator \mathcal{O} , to obtain its dimension Δ we would need to perform a large number of complex calculations. Integrability directly provides us with a function of the form:

$$f(\Delta, \lambda) = 0 \tag{5.1}$$

obtained as a solution of a set equations. In some regimes, these remain hard to solve although it is believed that it is possible.

Integrability leads us to find the same function for both type IIB on $AdS_5 \times S^5$ as for $\mathcal{N} = 4$ SYM. Moreover, on top of giving us a reliable spectrum for conformal dimensions, it provides us with promising ways of computing other observables in the theory.

The purpose of this section is to simply give the reader a taster of integrability, so we will only here sketch the way that one can link $\mathcal{N} = 4$ SYM to an integrable system: the spin chain.

Relating $\mathcal{N} = 4$ SYM to spin chains

Here we aim to show how one might obtain the spectrum of conformal dimensions for operators in the planar limit of SYM. If we recall, the two point correlation function had the form:

$$\langle \mathcal{O}(x)\mathcal{O}(y) \rangle \sim \frac{1}{|x-y|^{2\Delta}} \tag{5.2}$$

We mainly considered protected operators, but for a general operator, Δ can be expressed as $\Delta = \Delta_0 + \gamma$ where Δ_0 is the classical “engineering” dimension, while γ is the quantum correction. When the coupling is small, the latter can be computed as usual by calculating loop diagrams. Then, γ will be small compared to Δ_0 and if we anticipate the divergence and introduce a cutoff λ we should be able to have:

$$\langle \mathcal{O}(x)\mathcal{O}(y) \rangle \sim \frac{1}{|x-y|^{2\Delta_0}} (1 + \gamma \ln(\Lambda^2|x-y|^2)) \quad (5.3)$$

The leading term can be obtained by computing tree level diagrams. Let’s do this for a scalar operator:

$$\mathcal{O}_{I_1 \dots I_L}(x) \equiv \frac{(4\pi^2)^{L/2}}{\sqrt{C_{I_1 \dots I_L}} N^{L/2}} \text{Tr}(\phi_{I_1}(x) \dots \phi_{I_L}(x)) \quad (5.4)$$

Where $C_{I_1 \dots I_L}$ determines the symmetry of the operator and I_k correspond to R-symmetry indices. We will see shortly why the prefactor is chosen that way. We seek to compute the tree level of the two point correlator, $\langle \mathcal{O}_{I_1 \dots I_L}(x)\mathcal{O}^{J_1 \dots J_L}(y) \rangle$. This can be written in terms of Feynman diagrams where L fields at x propagate to y . There are many such diagrams contributing, as shown in figure 5.1. This is where the planar limit comes into

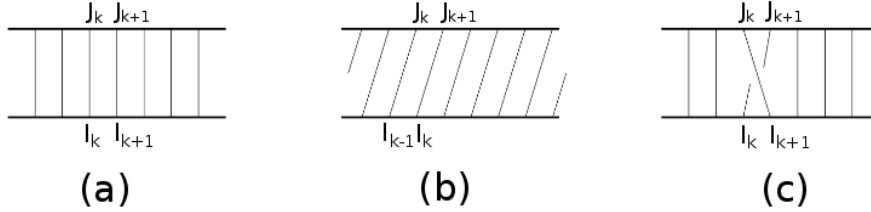

Figure 5.1: Examples of diagrams contributing to the two point function at tree level. Each horizontal segment corresponds to fields that are part of the operators, while the horizontal lines are the contractions. (a) and (b) correspond to planar diagram, while (c) is a non-planar diagram. [37]

play: some of the diagrams, such as (a) and (b) come from contractions (of gauge group indices) between neighbouring fields. Each contraction comes with a factor of $\delta_I^J = N$ and there are N such contractions, yielding a factor of N^L . Furthermore, there are L such diagrams. To see this, simply note that once we make one contractions, all the others are determined for planar diagrams. Then it is easy to see that I_1 , for instance, can have L different contractions. Meanwhile, diagrams like (c) have a lesser factor of N since they are conducive to less loops, in exactly the same way that we saw in section 2.5. In the planar limit these diagrams therefore become irrelevant. So we have that at tree level:

$$\langle \mathcal{O}_{I_1 \dots I_L}(x)\mathcal{O}^{J_1 \dots J_L}(y) \rangle = \frac{1}{C_{I_1 \dots I_L}} \frac{(\delta_{I_1}^{J_1} \dots \delta_{I_L}^{J_L} + \text{cycles})}{|x-y|^{2L}} \quad (5.5)$$

This is what we expect if we remember that scalars have bare dimension 1.

Moving forwards, we can compute one loop contributions to the two point function, in order to get an expression for γ . There are several interactions we must consider. Looking at (2.44), there are several interactions that will be of relevance. There will be some quartic scalar interactions, as well as contributions coming from diagrams with gluons. A few examples are shown in figure 5.2. Once again, we only consider planar diagrams as these

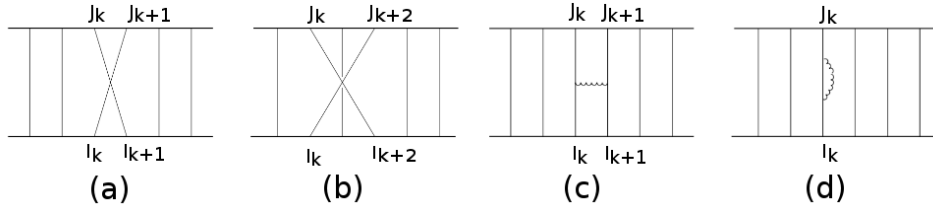

Figure 5.2: Examples of diagrams contributing to the two point function at the one loop level. (a) is a planar scalar loop. (b) corresponds to a non-planar diagram, while (c) and (d) are gluon interaction diagrams . [37]

alone will contribute when $N \rightarrow \infty$. When one computes these diagrams, performing the usual loop integrals with a cutoff Λ , we find the result [37]:

$$\langle \mathcal{O}_{I_1 \dots I_L}(x) \mathcal{O}^{J_1 \dots J_L}(y) \rangle \Big|_{1loop} = \frac{\lambda}{16\pi^2} \frac{\ln(\Lambda^2|x-y|^2)}{\sqrt{C_{I_1 \dots I_L} C_{J_1 \dots J_L}}} \sum_{l=1}^L (-1 + C + 2P_{l,l+1} - K_{l,l+1}) \frac{(\delta_{I_1}^{J_1} \dots \delta_{I_L}^{J_L} + cycles)}{|x-y|^{2L}} \quad (5.6)$$

Where C is a constant coming from the gluon diagrams. $P_{l,l+1}$ is an exchange operator, it swaps the l^{th} and the $(l+1)^{\text{th}}$ indices. $K_{l,l+1}$ is a trace operator, contracting the l^{th} and the $(l+1)^{\text{th}}$ indices. These operators arise since we can have nearest neighbour contractions.

We can now read off an expression for the anomalous dimension, γ . Rather, we now have an L by L matrix, Γ , given by:

$$\Gamma = \frac{\lambda}{16\pi^2} \sum_{l=1}^L (1 - C - 2P_{l,l+1} + K_{l,l+1}) \quad (5.7)$$

This matrix can be diagonalised. Its eigenstates will be operators of SYM with L scalar fields. The eigenvalues will be the corresponding 1-loop level corrections to the dimension.

Since operators are composed of traces, we expect Γ to yield the same result after we do a cyclic shift. This is the case since the operators P and K act on every adjacent pairs of fields.

Note that we can use a clever trick to determine C . We take \mathcal{O} to be a properly normalized chiral primary operator. From section 2.3.2, we remember

that these are purely symmetric traceless combinations of scalars. Therefore, $P\mathcal{O} = \mathcal{O}$. Furthermore, it is built up of only X s and no conjugates, so $K\mathcal{O} = 0$. Finally, we know that these operators are protected, so the quantum corrections to their dimensions should vanish at all orders. Hence:

$$0 = \Gamma\mathcal{O} \propto \sum_{l=1}^L (-1 + C + 2) \quad (5.8)$$

so $C = -1$.

The key step for integrability is to realise that Γ is actually the Hamiltonian for a spin chain with L sites! Here only neighbouring interactions are included, but in general, the n^{th} loop correction will correspond to n^{th} neighbouring sites. As shown in [36], these spin chain systems are solvable, giving us an expression for the spectrum for the scaling dimension. There also exists generalizations of this Γ operator for generic operators in SYM, as shown in [5],[3].

This was just a taster to show the starting point of the uses of integrability in AdS/CFT. Plenty more can be found in [4] and its various chapters.

5.2 AdS/CMT

The holographic principle, and the AdS/CFT correspondence have recently made themselves quite useful in a very different field of physics: Condensed Matter.

We have a good understanding of 2+1 dimensional quantum field theories with a finite charge density. Indeed, the low temperature phases are easily classified: bosonic states form Bose-Einstein condensates, while fermions, constrained by the exclusion principle make a Fermi surface. This fairy tale ends when we consider strongly coupled systems however. In this case, understanding the different low temperature phases becomes more complicated. One may then use the holographic principle to make the matter more tractable.

First, we will briefly introduce a toy model, and outline how we can see that it is indeed possible to find a holographic dual to a boundary CFT. The model we consider is the 2+1 dimensional lattice with bosons that have repulsive interactions. This is described by the Hubbard Hamiltonian:

$$H_b = -w \sum_{\langle ij \rangle} (b_i b_j^\dagger + b_j^\dagger b_i) + \frac{U}{2} \sum_i n_i (n_i - 1) \quad (5.9)$$

Where b_i is the boson annihilation operator, n_i is the number operator. w is the “hopping” matrix and measure the attractive strength between the bosons. U , on the other hand measures the repulsive strength between them. There are two different phases in this model. When $\frac{U}{w} \equiv g$ is small, then the bosons tend to occupy the same sites in their ground states, and thus undergo Bose-Einstein condensation. This is the superfluid phase. When g is large, ground state bosons occupy their own sites, and we have an insulator phase.

These phases behave differently, and are connected by a quantum critical point at $g = g_c$.

The low energy excitations of this model (as well as other models featuring this phase transition) can be described in terms of a field theory with complex scalar fields, $\Phi(x, t)$. The latter is defined by:

$$S_b = \int dx^2 dt (\partial_\mu \Phi)^2 + (g - g_c) \Phi^2 + u \Phi^4 \quad (5.10)$$

It is interesting to see that in the above, at the critical point, the theory actually loses its mass term, and becomes conformal. If we consider the dynamics for non-zero temperatures, we obtain the phase diagram shown in figure 5.3. The blue regions of the diagram are well understood respectively.

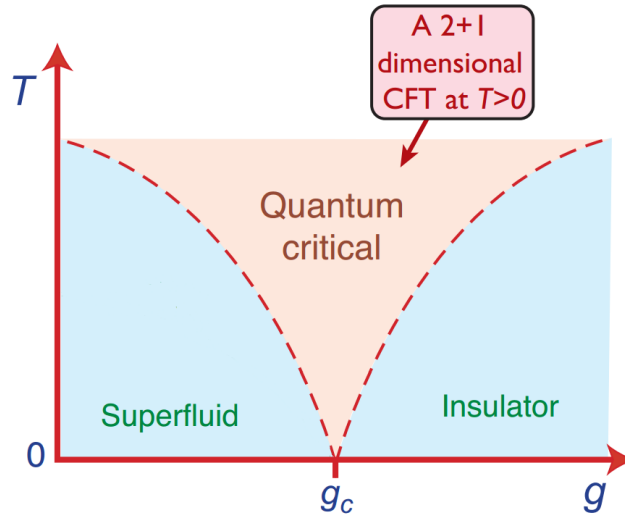

Figure 5.3: Phase diagram showing the insulator-superfluid transition. [45]

However, the quantum critical region is described by a strongly interacting QFT. This is a hard problem to solve, but there are things we can do. We focus our attention on an observable: the physical conductivity. If our bosons have an electric charge, we can describe the response to an electric field, $\sigma(\omega)$,

coupling to a field oscillating at frequency ω . Although the response in the Quantum critical regime is unknown, we can determine its qualitative behaviour from our knowledge of the other two phases. This behaviour differs depending on if we approach the problem from the superfluid phase or the insulator phase. Both cases are shown in figure 5.4. It is interesting to note

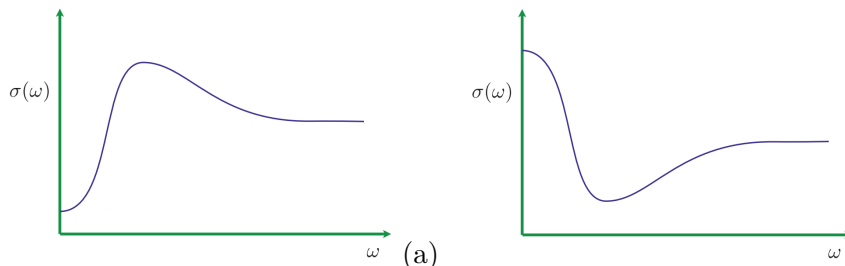

Figure 5.4: Expected form of the conductivity in the Quantum critical phase. **LEFT** Expected form when using superfluid excitation methods. **RIGHT** Expected form when using insulator excitation methods. [45]

that it is not known which is the correct behaviour that describes the CFT.

We can now use holography and attempt to find a setting that is dual to this theory and will thus reproduce these behaviours. We look for 4 dimensional actions that map onto general 3 dimensional CFTs. It turns out that we must consider the Maxwell-Einstein equation with negative cosmological constant:

$$S_{ME} = \int d^4x \left(\frac{1}{2\kappa} (R + \frac{6}{L^2}) - \frac{1}{4e^2} F_{\mu\nu} F^{\mu\nu} \right) \quad (5.11)$$

where κ is related to Newton's constant, R is the Ricci scalar and $F_{\mu\nu}$ is the usual $U(1)$ field strength. A solution with $F_{\mu\nu} = 0$ is AdS_4 . The $U(1)$ gauge field of this action will then be dual to a current, J_μ , at the boundary. To calculate the conductivity, one needs to compute the two-point correlator of this current. This can be done by adding a source term in the CFT action:

$$S_{CFT} \rightarrow S_{CFT} + \int d^2x dt K_\mu J^\mu \quad (5.12)$$

Where, K_μ is simply the boundary value of the bulk gauge field A_μ :

$$A_\mu(x, t, z \rightarrow 0) = K_\mu(x, t) \quad (5.13)$$

However, before moving forwards, we need to introduce a temperature in our theory. This is done by considering the AdS black brane solution given

by:

$$ds^2 = \left(\frac{L}{r}\right)^2 \left(\frac{dr^2}{f(r)} + (-f(r)dt^2 + dx^2 + dy^2)\right) \quad (5.14)$$

$$f(r) = 1 - \left(\frac{Rr}{L}\right)^3 \quad (5.15)$$

where L is the AdS curvature and R is the position of the black brane horizon. This has a Hawking temperature given by:

$$k_B T = \frac{3\hbar c R}{4\pi L^2} \quad (5.16)$$

Finally, in order to truly get a spacetime dual to our Hubbard model, and not just any CFT we need to add the following term to the Einstein-Maxwell action :

$$\int d^4x \sqrt{-g} \frac{\gamma L^2}{e^2} C_{\mu\nu\rho\sigma} F^{\mu\nu} F^{\rho\sigma} \quad (5.17)$$

where e and γ are dimensionless parameters, and $C_{\mu\nu\rho\sigma}$ is the Weyl curvature. Finally, from there the conductivity can be computed. This is done by computing the characteristics of the CFT at $T = 0$ to fix the parameters in the gravity theory. We can then perform the computations for all $T > 0$. By scaling the conductivity, we can make it so that it is only dependent on the parameter γ and not e . In this case, in order to have a stable gravity theory, we require $-1/12 < \gamma < 1/12$. The result is shown for the extremal values of γ in figure 5.5.

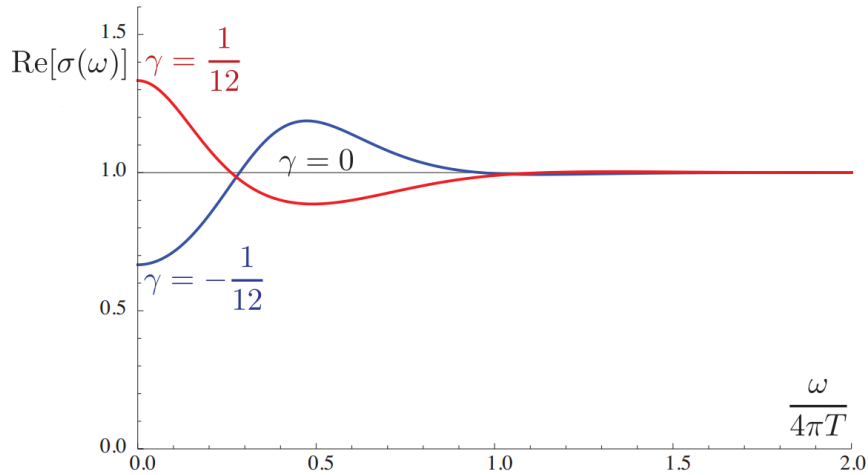

Figure 5.5: Expected conductivity in the 3 dimensional CFT from holography for $\gamma = -1/12, 0,$ and $1/12$. [45]

We see that we recover the behaviours shown in figure 5.4! Indeed, for positive values of γ , we obtain the result we had using the insulator method while negative values correspond to results obtained from the superfluid regime. [45].

Going further, one can find the holographic dual of a superconductor. This was introduced in [18], [23] and is done by once again starting from 5.11 and then considering an AdS Reissner-Nördstrom black hole in the bulk. The latter has the metric:

$$ds^2 = \frac{L^2}{r^2} \left(-f(r)dt^2 + \frac{dr^2}{f(r)} + dx^2 + dy^2 \right) \quad (5.18)$$

$$f(r) = 1 - \left(1 + \frac{r_+^2 \mu^2}{2\gamma^2} \right) \left(\frac{r}{r_+} \right)^3 + \frac{r_+^2 \mu^2}{2\gamma^2} \left(\frac{r}{r_+} \right)^4 \quad (5.19)$$

$$\gamma^2 = \frac{e^2 L^2}{\kappa^2} \quad (5.20)$$

where r_+ is the radial position of the horizon. If we then add charged scalars in the bulk, things become more interesting. For instance, if we add to the Einstein Maxwell Lagrangian:

$$\mathcal{L}_{scalar} = -|\partial_\mu \Phi - iA_\mu \Phi|^2 - m^2 |\Phi|^2 - V(|\Phi|) \quad (5.21)$$

we obtain an interesting bound. Near the horizon, we find that if:

$$\frac{1}{6}(m^2 L^2 - \gamma^2) \leq -\frac{1}{4} \quad (5.22)$$

then the spacetime becomes unstable to pair production. That is to say, there is enough energy from the electrostatic potential emanating from the black hole for pair production to occur. What then happens is that the negative charges will fall behind the horizon. Meanwhile, if the temperature is below a certain critical point, the positive charges remain in the bulk and undergo Bose-Einstein condensation! This is illustrated in figure 5.6. [22] Another interesting endeavour is to have charged fermions in the bulk instead. This leads to a similar scenario with the exception that a Fermi surface forms, since fermions cannot condensate. This is called an “electron star”.

In this section we have very briefly outlined some of the ways that the correspondence is used in Condensed Matter theory. There many more, however and the reader is directed to [45] and [22].

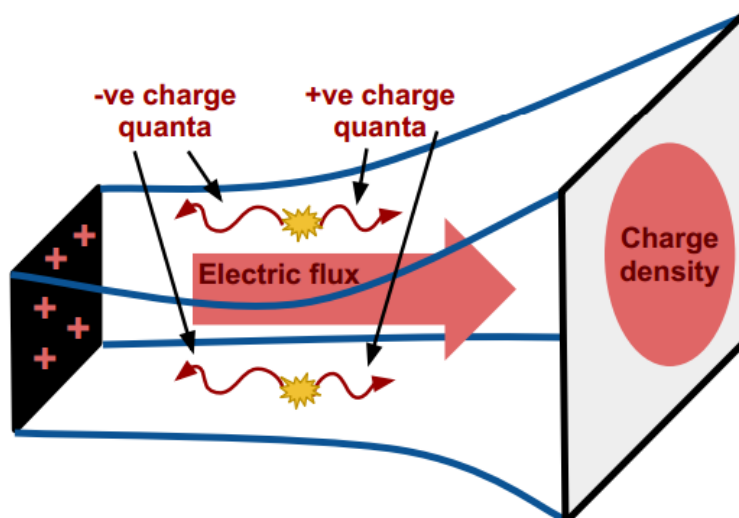

Figure 5.6: Pair production in the bulk the left boundary is the horizon while the right boundary is the boundary of AdS_4 . [22]

5.3 Concluding words

In this review, we have built up, almost from scratch, the machinery required to understand the basics of the duality between $\mathcal{N} = 4$ SYM and type IIB string theory. We then motivated then stated it and its different limits. We built up (at least partly) the dictionary, and we able to match some of the most basic observables of the theory.

With this knowledge, the reader should realise how powerful the correspondence is. String theory is notoriously complicated, and the correspondence gives us a tool to tackle some of its problems. In fact, one can use it to give a better definition to some string theories from known gauge theories.

More than that, the correspondence now has a myriad of applications and different developments - some of which we have mentioned in this last chapter - and it has bloomed into a fully-blown field of research.

Acknowledgments

I would like to thank Daniel Waldram for his infinite patience and invaluable help in guiding me as well as helping me understand some of the key concepts. I would also like to thank Nick Poovuttikul for the many discussions that have helped me construct a better picture of the correspondence, as well as view it from a different perspective, and Matthew Citron for moral support.

Appendix A

Conformal Algebra

$$[K_\mu, P_\nu] = 2i\eta_{\mu\nu}D + 2iM_{\mu\nu} \quad (\text{A.1})$$

$$[M_{\mu\nu}, P_\alpha] = i(\eta_{\alpha\nu}P_\mu - \eta_{\alpha\mu}P_\nu) \quad (\text{A.2})$$

$$[M_{\mu\nu}, K_\alpha] = i(\eta_{\alpha\nu}K_\mu - \eta_{\alpha\mu}K_\nu) \quad (\text{A.3})$$

$$[D, P_\mu] = -iP_\mu \quad (\text{A.4})$$

$$[D, K_\mu] = iK_\mu \quad (\text{A.5})$$

$$[M_{\mu\nu}, M_{\alpha\beta}] = i(\eta_{\nu\alpha}M_{\mu\beta} \pm \text{permutations}) \quad (\text{A.6})$$

This is actually the algebra of $SO(1, d+1)$, ie the Lorentz Algebra in $d+2$ dimensions.

Appendix B

Superconformal Algebra

Here are the (schematic) relations not included in appendix A. [52]

$$[D, \mathcal{Q}] = -\frac{1}{2}\mathcal{Q} \quad (\text{B.1})$$

$$[D, \bar{\mathcal{Q}}] = -\frac{1}{2}\bar{\mathcal{Q}} \quad (\text{B.2})$$

$$[D, S] = \frac{1}{2}S \quad (\text{B.3})$$

$$[D, \bar{S}] = \frac{1}{2}\bar{S} \quad (\text{B.4})$$

$$[P, \mathcal{Q}] = [P, \bar{\mathcal{Q}}] = 0 \quad (\text{B.5})$$

$$[K, S] = [K, \bar{S}] = 0 \quad (\text{B.6})$$

$$\{\mathcal{Q}, \mathcal{Q}\} = \{S, S\} = \{\mathcal{Q}, \bar{S}\} = 0 \quad (\text{B.7})$$

$$\{\mathcal{Q}_\alpha^a, \bar{\mathcal{Q}}_{\dot{\beta}b}\} = 2\sigma_{\alpha\dot{\beta}}^\mu P_\mu \delta_b^a \quad (\text{B.8})$$

$$\{S_{\alpha a}, S_{\dot{\beta}}^b \bar{S}\} = 2\sigma_{\alpha\dot{\beta}}^\mu K_\mu \delta_b^a \quad (\text{B.9})$$

$$\{\mathcal{Q}_\alpha^a, S_{\beta b}\} = \epsilon_{\alpha\beta}(\delta_b^a D + T_b^a) + 1/2\delta_b^a M_{\mu\nu}\sigma_{\alpha\beta}^{\mu\nu} \quad (\text{B.10})$$

Where T_b^a are the R-Symmetry generators.

Appendix C

Wilson loops in QED

In this appendix, we perform the integral in (2.61) We begins by making the substitution $u = t_2 - t_1$ and perform the first integral:

$$\text{diag(a)} = \int_0^T dt_1 \int_{-t_1}^{T-t_1} du \frac{1}{R^2 + u^2} \quad (\text{C.1})$$

$$= \frac{1}{R^2} \int_0^T dt_1 \int_{-t_1}^{T-t_1} du \frac{1}{1 + \frac{u^2}{R^2}} \quad (\text{C.2})$$

$$= \frac{1}{R} \int_0^T dt_1 \left(\arctan\left(\frac{T-t_1}{R}\right) + \arctan\left(\frac{t_1}{R}\right) \right) \quad (\text{C.3})$$

We now split the integral and use the change of variables $u = \frac{T-t_1}{R}$ for the first term and $v = \frac{t_1}{R}$:

$$\text{diag(a)} = - \int_{T/R}^0 du \arctan u + \int_0^{T/R} dv \arctan v \quad (\text{C.4})$$

$$2 \int_0^{T/R} du \arctan u \quad (\text{C.5})$$

Where we have used the fact that \arctan is odd. This is easily solved using integration by parts, and we find:

$$\text{diag(a)} = \frac{2T}{R} \arctan\left(\frac{T}{R}\right) - \log\left(\frac{T^2}{R^2} + 1\right) \quad (\text{C.6})$$

Bibliography

- [1] Ofer Aharony, Steven S. Gubser, Juan Martin Maldacena, Hirosi Ooguri, and Yaron Oz. Large N field theories, string theory and gravity. *Phys.Rept.*, 323:183–386, 2000.
- [2] Katrin Becker, Melanie Becker, and John H. Schwarz. *String Theory and M-Theory: A Modern Introduction*. Cambridge University Press, 1 edition, January 2007.
- [3] Niklas Beisert. The complete one loop dilatation operator of N=4 superYang-Mills theory. *Nucl.Phys.*, B676:3–42, 2004.
- [4] Niklas Beisert, Changrim Ahn, Luis F. Alday, Zoltan Bajnok, James M. Drummond, et al. Review of AdS/CFT Integrability: An Overview. *Lett.Math.Phys.*, 99:3–32, 2012.
- [5] Niklas Beisert and Matthias Staudacher. The N=4 SYM integrable super spin chain. *Nucl.Phys.*, B670:439–463, 2003.
- [6] Jacob Bekenstein, D. Generalized second law of thermodynamics in black-hole physics. *Phys.Rev.D.*, 1974.
- [7] David Eliecer Berenstein, Richard Corrado, Willy Fischler, and Juan Martin Maldacena. The Operator product expansion for Wilson loops and surfaces in the large N limit. *Phys.Rev.*, D59:105023, 1999.
- [8] Raphael Bousso. The Holographic principle. *Rev.Mod.Phys.*, 74:825–874, 2002.
- [9] Eric D’Hoker and Daniel Z. Freedman. Supersymmetric gauge theories and the AdS / CFT correspondence. pages 3–158, 2002.
- [10] Eric D’Hoker, Daniel Z. Freedman, and Witold Skiba. Field theory tests for correlators in the AdS / CFT correspondence. *Phys.Rev.*, D59:045008, 1999.
- [11] Michael R. Douglas and S. Randjbar-Daemi. Two lectures on the AdS / CFT correspondence. 1999.

- [12] Nadav Drukker and David J. Gross. An Exact prediction of N=4 SUSYM theory for string theory. *J.Math.Phys.*, 42:2896–2914, 2001.
- [13] Nadav Drukker, David J. Gross, and Hiroshi Ooguri. Wilson loops and minimal surfaces. *Phys.Rev.*, D60:125006, 1999.
- [14] J.K. Erickson, G.W. Semenoff, and K. Zarembo. Wilson loops in N=4 supersymmetric Yang-Mills theory. *Nucl.Phys.*, B582:155–175, 2000.
- [15] Sergio Ferrara and Alberto Zaffaroni. Superconformal field theories, multiplet shortening, and the AdS(5) / SCFT(4) correspondence. pages 177–188, 1999.
- [16] Daniel Z. Freedman, Samir D. Mathur, Alec Matusis, and Leonardo Rastelli. Correlation functions in the CFT(d) / AdS(d+1) correspondence. *Nucl.Phys.*, B546:96–118, 1999.
- [17] Paul H. Ginsparg. APPLIED CONFORMAL FIELD THEORY. 1988.
- [18] Steven S. Gubser. Breaking an Abelian gauge symmetry near a black hole horizon. *Phys.Rev.*, D78:065034, 2008.
- [19] Steven S. Gubser, Igor R. Klebanov, and Arkady A. Tseytlin. String theory and classical absorption by three-branes. *Nucl.Phys.*, B499:217–240, 1997.
- [20] M Gunaydin and N Marcus. The spectrum of the s 5 compactification of the chiral n=2, d=10 supergravity and the unitary supermultiplets of u(2,2/4). *Classical and Quantum Gravity*, 2(2):L11, 1985.
- [21] Amihay Hanany. Selected Topics in Theoretical Particle Physics: Branes and Gauge Theory Dynamics. Available at : <http://ocw.mit.edu/courses/physics/8-871-selected-topics-in-theoretical-particle-physics-branes-and-gauge-theory-dynamics-fall-2004>.
- [22] Sean A. Hartnoll. Horizons, holography and condensed matter. 2011.
- [23] Sean A. Hartnoll, Christopher P. Herzog, and Gary T. Horowitz. Building a Holographic Superconductor. *Phys.Rev.Lett.*, 101:031601, 2008.
- [24] D. Hawking, S. Black holes and thermodynamics. *Phys.Rev.D.*, 1976.
- [25] Christopher P. Herzog, Igor R. Klebanov, and Peter Ouyang. D-branes on the conifold and N=1 gauge / gravity dualities. 2002.
- [26] Gary T. Horowitz and Joseph Polchinski. Gauge/gravity duality. 2006.

- [27] H. J. Kim, L. J. Romans, and P. van Nieuwenhuizen. Mass spectrum of chiral ten-dimensional $N=2$ supergravity on S^5 . *Phys. Rev. D*, 32:389–399, Jul 1985.
- [28] Igor R. Klebanov. From three-branes to large N gauge theories. 1999.
- [29] Stefano Kovacs. N=4 supersymmetric Yang-Mills theory and the AdS / SCFT correspondence. 1999.
- [30] Juan Martin Maldacena. The Large N limit of superconformal field theories and supergravity. *Adv.Theor.Math.Phys.*, 2:231–252, 1998.
- [31] Juan Martin Maldacena. Wilson loops in large N field theories. *Phys.Rev.Lett.*, 80:4859–4862, 1998.
- [32] Juan Martin Maldacena. TASI 2003 lectures on AdS / CFT. pages 155–203, 2003.
- [33] John McGreevy. 8.821 String Theory, Fall 2008. MIT OpenCourseWare: Massachusetts Institute of Technology, <http://ocw.mit.edu/courses/physics/8-821-string-theory-fall-2008> License: Creative Commons BY-NC-SA.
- [34] John McGreevy. Explorations in String Theory.
- [35] John McGreevy. Holographic duality with a view toward many-body physics. *Adv.High Energy Phys.*, 2010:723105, 2010.
- [36] J.A. Minahan and K. Zarembo. The Bethe ansatz for N=4 superYang-Mills. *JHEP*, 0303:013, 2003.
- [37] Joseph A. Minahan. Review of AdS/CFT Integrability, Chapter I.1: Spin Chains in N=4 Super Yang-Mills. *Lett.Math.Phys.*, 99:33–58, 2012.
- [38] C. Montonen and David I. Olive. Magnetic Monopoles as Gauge Particles? *Phys.Lett.*, B72:117, 1977.
- [39] Di Francesco Philippe, Pierre Mathieu, and David Sénéchal. *Conformal Field Theory (Graduate Texts in Contemporary Physics)*. Springer, corrected edition, January 1999.
- [40] Joseph Polchinski. Dirichlet Branes and Ramond-Ramond charges. *Phys.Rev.Lett.*, 75:4724–4727, 1995.
- [41] Joseph Polchinski. Tasi lectures on D-branes. pages 293–356, 1996.
- [42] Joseph Polchinski. *String Theory, Vol. 2 (Cambridge Monographs on Mathematical Physics)*. Cambridge University Press, July 2005.

- [43] M. Porrati. Universal Limits on Massless High-Spin Particles. *Phys.Rev.*, D78:065016, 2008.
- [44] Fernando Quevedo, Sven Krippendorf, and Oliver Schlotterer. Cambridge Lectures on Supersymmetry and Extra Dimensions. 2010.
- [45] S. Sachdev. What can gauge-gravity duality teach us about condensed matter physics? *ArXiv e-prints*, August 2011.
- [46] Kostas Skenderis. Lecture notes on holographic renormalization. *Class.Quant.Grav.*, 19:5849–5876, 2002.
- [47] Leonard Susskind. The World as a hologram. *J.Math.Phys.*, 36:6377–6396, 1995.
- [48] Gerard 't Hooft. Dimensional reduction in quantum gravity. 1993.
- [49] Antoine Van Proyen. $N = 2$ supergravity in $d = 4, 5, 6$ and its matter couplings. Available at : <http://itf.fys.kuleuven.be/toine/LectParis.pdf>.
- [50] Pedro Vieira. Explorations in String Theory. Lectures given at Perimeter Institute. Available at : <http://perimeterscholars.org/417.html> and <http://perimeterscholars.org/341.html>.
- [51] Steven Weinberg and Edward Witten. Limits on massless particles. *Physics Letters B*, 96(12):59 – 62, 1980.
- [52] J. Wess and J. Bagger. Supersymmetry and supergravity. 1992. Princeton, USA: Univ. Pr. (1992) 259 p.
- [53] Edward Witten. Anti-de Sitter space and holography. *Adv.Theor.Math.Phys.*, 2:253–291, 1998.
- [54] A Zee. *"Einstein Gravity in a Nutshell"*. Princeton University Press, 2013.